

# QST



**DIGITAL EDITION**



**ARRL** The national association for  
**AMATEUR RADIO®**

March 2020 [www.arrl.org](http://www.arrl.org)

DEVOTED ENTIRELY TO AMATEUR RADIO

# Make Your Own Open-Wire Line

## QST Reviews

Xiegu G90 HF Transceiver  
SOTABEAMS  
Wolfware Audio Processor  
Inexpensive Antenna  
System Tuning Indicators

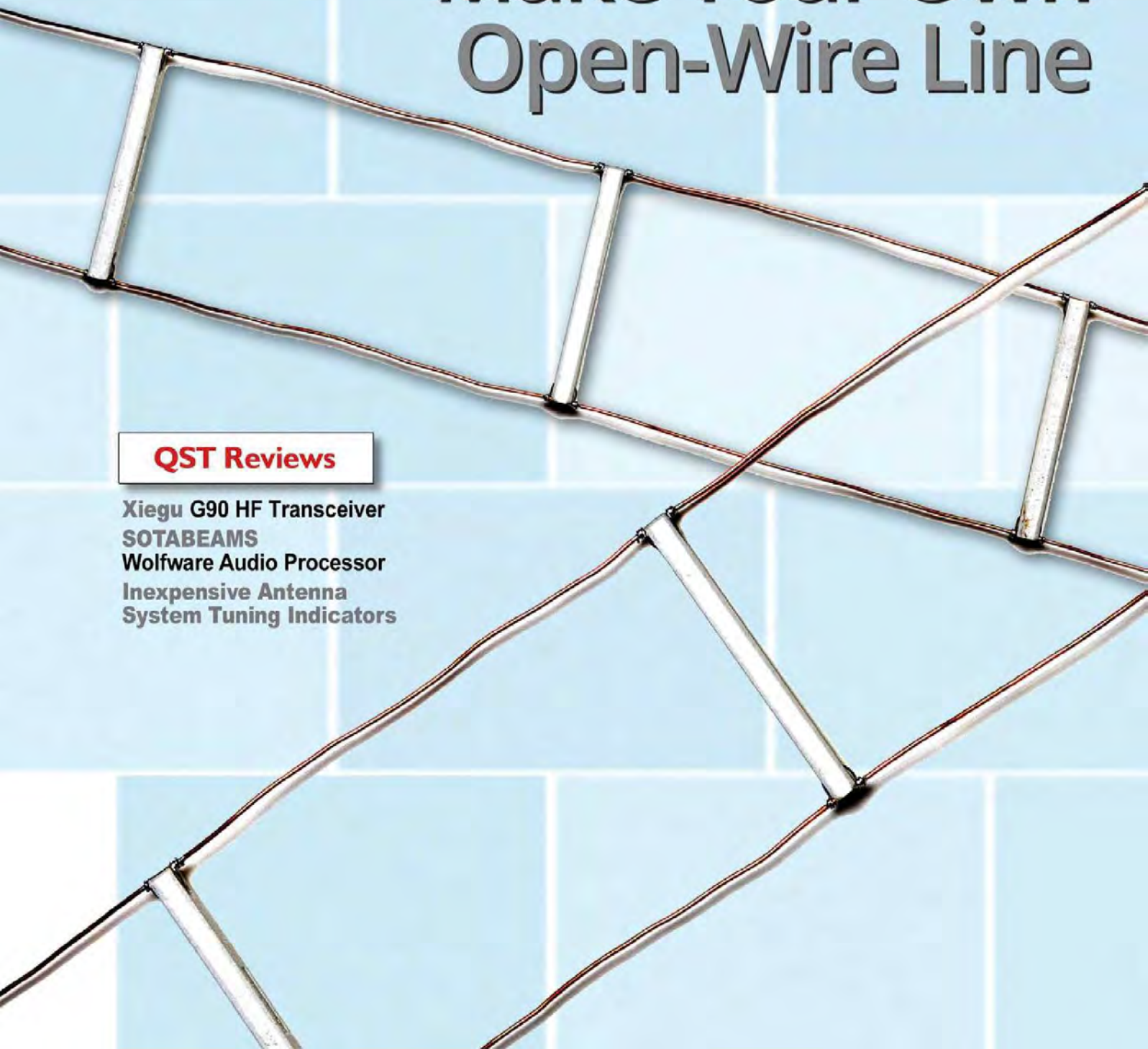

## FTdx101 TECHNICAL HIGHLIGHT-#4

### 3DSS (3-Dimensional Spectrum Stream)

Displays the constantly changing band conditions in 3D  
Instantly observe changes in the strength of the signals

- Display up to 25 seconds of previous band conditions in real time
- Simultaneously view output from both Narrow band SDR and Direct Sampling SDR on the display
- Versatile scope and multi-color SDR display configuration enables clear and easy viewed presentation provided by 7" TFT Color touch panel display

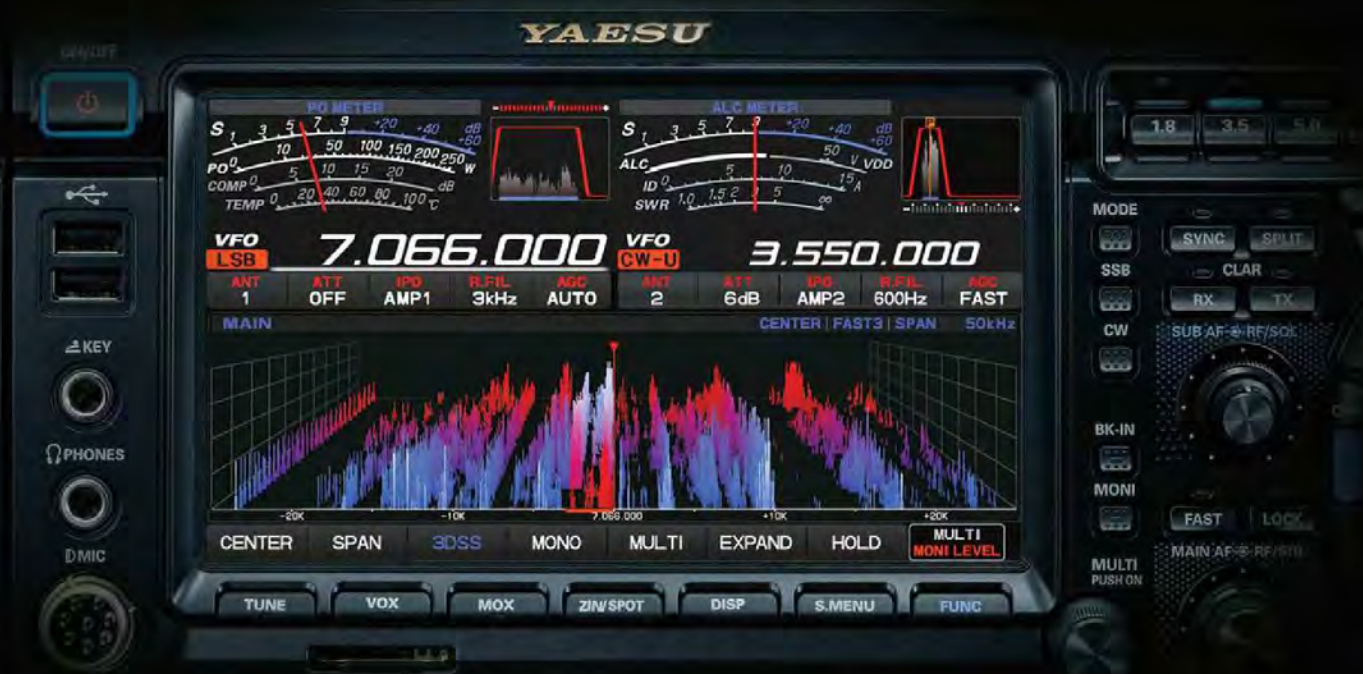

HF/50MHz TRANSCEIVER

**FTdx101MP** 200W

HF/50MHz TRANSCEIVER

**FTdx101D** 100W



\* Microphone M-1: Optional



C4FM/FM 144/430 MHz  
Dual Band 5W  
Digital Transceiver  
**FT-70DR**  
« 700 mW Loud and Clear audio,  
Commercial Grade Specifications »



**WIRES-X**  
Portable Digital Node  
Available  
C4FM/FM 144/430 MHz  
Dual Band 5 W  
Digital Transceiver  
**FT3DR**  
« Improved 66 ch  
GPS receiver included »



**WIRES-X**  
Portable Digital Node  
Available  
C4FM/FM 144/430 MHz  
Dual Band 5 W  
Digital Transceiver  
**FT2DR**  
« Improved 66 ch  
GPS receiver included »

# System Fusion II

**C4FM Digital  
Pursuing Advanced Communications**

**WIRES-X**  
Portable Digital Node  
Available



C4FM/FM  
144/430 MHz Dual Band 50 W  
Digital Transceiver  
**FTM-100DR**  
« Improved 66 ch GPS receiver included »



C4FM/FM 144/430 MHz  
Dual Band Dual Receive Digital Repeater  
**DR-2X**

**WIRES-X**  
Portable Digital Node  
Available



C4FM/FM  
144/430 MHz Dual Band 50 W  
Digital Transceiver  
**FTM-400XDR**  
« Improved 66 ch GPS receiver included »



C4FM/FM 144/430 MHz Dual Band 50 W  
Digital Transceiver  
**FTM-7250DR**  
« Heavy Duty 50 Watts High Power »



C4FM/FM 144 MHz 65 W  
Digital Transceiver  
**FTM-3200DR**  
« Genuine 65 Watts High Power »



CW/SSB/AM/FM/C4FM  
HF/50/144/430 MHz Wide-Coverage  
100 W All Mode Transceiver (144/430 MHz: 50 W)  
**FT-991A**  
« Real-Time Spectrum Scope included »



C4FM/FM 430 MHz 55 W  
Digital Transceiver  
**FTM-3207DR**  
« Heavy Duty 55 Watts High Power »

**System Fusion II Supports All C4FM Portables and Mobiles**

**YAESU**  
The radio

YAESU USA  
6125 Phyllis Drive, Cypress,  
CA 90630 (714) 827-7600

For the latest Yaesu news, visit us on the Internet: <http://www.yaesu.com>

Specifications subject to change without notice. Some accessories and/or options may be standard in certain areas. Frequency coverage may differ in some countries. Check with your local Yaesu Dealer for specific details.

Cushcraft...Keeping You in Touch Around the Globe

# Cushcraft Antennas

# R9

## 80-6 Meters! No Radials!

**Cushcraft's world famous R8 now has a big brother!**

**Big Brother R9** now includes 75/80 Meters for local ragchewing and worldwide low band DX without radials!

**It's** omni-directional low angle radiation gives you exciting and easy DX on all 9 bands: 75/80, 40, 30, 20, 17, 15, 12, 10 and 6 Meters with low SWR. QSY instantly - no antenna tuner needed.

**Use** full 1500 Watts SSB/CW when the going gets tough to break through pileups and poor band conditions.

**The R9** is super easy to assemble, installs just about anywhere, and its low profile blends inconspicuously into the background in urban and country settings alike.

**Compact Footprint:** Installs in an area about the size of a child's sandbox - no ground radials to bury with all RF-energized surfaces safely out of reach.

**Rugged Construction:** Thick fiberglass insulators, all stainless steel hardware and 6063 aircraft-aluminum tubing is double or triple walled at key stress points to handle anything Mother Nature can dish out.

**31.5** feet tall, 25 lbs. Mounting mast 1.25 to 2 inches. Wind surface area is 4 square feet.

**R8, \$599.95.** Like R9 antenna but less 75/80 Meters.

**R-8TB, \$99.95.** Tilt-base lets you tilt your antenna up/down easily by yourself to work on.

**R-8GK, \$79.95.** Three-point guy kit for high winds.

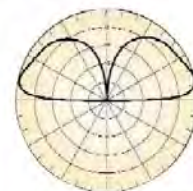
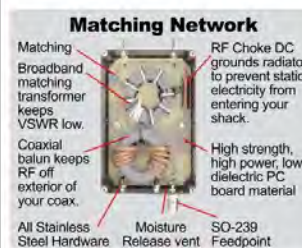

**Cushcraft...Keeping You in Touch Around the Globe!**





**Life is a JOURNEY.  
Enjoy the ride!**

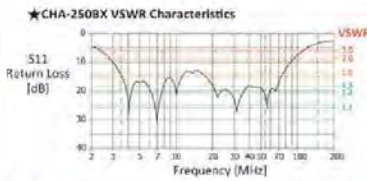

**CHA-250B - No Antenna Tuner Needed!**



## Base Antennas

### 1 COMET CHA-250B BROADBAND 80M THROUGH 6M VERTICAL ANTENNA

A newly designed broadband vertical with NO GROUND RADIALS. EXTREMELY easy to assemble, requires no tuning or adjustments and VSWR is under 1.5:1 from 3.5-57MHz! • TX: 3.5MHz – 57MHz • RX: 2.0– 90MHz • VSWR is 1.5:1 or less, continuous • Max Power: 250W SSB/125W FM • Impedance: 50 Ohm • Length: 23' 5" • Weight: 7 lbs. 1 oz. • Conn: SO-239 • Mast Req'd: 1" – 2" dia. • Max wind speed: 67MPH

### 2 Maldol HVU-8 ULTRA-COMPACT 8 BAND HF/VHF/UHF VERTICAL ANTENNA

80/40/20/15/10/6/2M/70cm Only 1/2 the traditional size and weight of vertical HF antennas, and it includes 2M/70cm! Unique radial system rotates for balcony installations, the radials can all be rotated to one side. • Wavelength: HF and 6M: 1/4 wave • 2M: 1/2 wave • 70cm: Two 5/8waves in phase • Impedance: 50 Ohm • Max Power: HF 200W SSB • 6M–70cm: 150W FM • Conn: SO-239 • Height: Only 8'6" • Weight: 5lbs. 7ozs.

### 3 COMET GP-3 DUAL-BAND 146/446MHZ BASE REPEATER ANTENNA

Wavelength: 146MHz 6/8 wave • 446MHz 5/8 wave x 3 • Max Pwr: 200W • Length: 5'11" • Weight: 2lbs. 9ozs. • Conn: Gold-plated SO-239 • Construction: Single-piece fiberglass

### 4 COMET GP-6 DUAL-BAND 146/446MHZ BASE REPEATER ANTENNA

Wavelength: 146MHz 5/8 wave x 2 • 446MHz 5/8 wave x 5 • Max Pwr: 200W • Length: 10'2" • Weight: 3lbs. 8ozs. • Conn: Gold-plated SO-239 • Construction: Fiberglass, 2 Sections

### 5 COMET GP-9 / GP-9N DUAL-BAND 146/446MHZ BASE REPEATER ANTENNA

BEST SELLER! • Wavelength: 146MHz 5/8 wave x 3 • 446MHz 5/8 wave x 8 • Max Pwr: 200W • Length: 16' 9" • Weight: 5lbs. 11ozs. • Conn: GP-9 Gold-plated SO-239 • GP-9N Gold-plated N-type female • Construction: Fiberglass, 3 Sections

### 6 COMET CX-333 TRI-BAND 146/220/446MHZ BASE REPEATER ANTENNA

Wavelength: 146MHz 5/8 wave x 2 • 220MHz 5/8 wave x 3 • 446MHz 5/8 wave x 5 • Max Pwr: 120W • Length: 10'2" • Weight: 3lbs. 1oz. • Conn: Gold-plated SO-239 • Construction: Fiberglass, 2 Sections

### 7 COMET GP-15 TRI-BAND 52/146/446MHZ BASE REPEATER ANTENNA

Wavelength: 52MHz 5/8 wave • 146MHz 5/8 wave x 2 • 446MHz 5/8 wave x 4 • Max Pwr: 150W • Length: 7'11" • Weight: 3lbs. 1oz. • Conn: Gold-plated SO-239 • 2MHz band-width after tuning (6M) • Construction: Single-piece fiberglass



### NEW CAA-500MarkII 1.8-500MHz Antenna analyzer

The CAA-500MarkII combines the simplicity and accuracy of an analog instrument, PLUS...a full color LCD graphic display • Resistive (R) and Reactive (X) components of impedance graphed and displayed numerically • SWR readings in both graphic and numerical results.

Operates on 8-16VDC external power, 6 AA Alkaline or NiMH rechargeable cells • Trickle charger built in (only when using NiMH batteries) • Typical battery life: 9 hours of continuous operation • Battery level indicator • Selectable auto power-off time limit preserves battery capacity • SO-239 connector for 1.8-300MHz range • N-female connector for 300-500MHz range

*The perfect combination of analog and graphic information, designed in particular for antenna diagnostics and adjustments while on the roof, tower or in the field!*

### CAA-55C

Protect your CAA-500MarkII from moisture, shock, dents and dings!

Shoulder strap included.



**Call or visit your local dealer today!**  
[www.natcommgroup.com](http://www.natcommgroup.com) | 800-962-2611



**Barry J. Shelley, N1VXY**  
Interim Publisher

**Steve Ford, WB8IMY**  
Editor

**Becky R. Schoenfeld, W1BXY**  
Managing Editor

**Jen Glifort, KC1KNL**  
Senior Editor

**Caroline Kenney**  
**Leanna Zwiebel**  
Assistant Editors

**Bart Jahnke, W9JJ**  
Radiosport & Field Services  
Manager

**Rick Lindquist, WW1ME**  
*Happenings*

**Bob Allison, WB1GCM**  
*Product Review Lab Testing*

**Mark J. Wilson, K1RO**  
**Al Brogdon, W1AB**  
**Bernie McClenny, W3UR**  
**H. Ward Silver, N0AX**  
**Paul Wade, W1GHZ**  
**Jon Jones, N0JK**  
**Rick Palm, K1CE**  
**Joel R. Hallas, W1ZR**  
**Barry Shackelford, W6YE**  
**Kai Siwiak, KE4PT**  
**Bruce Draper, AA5B**  
Contributing Editors

**Michelle Bloom, WB1ENT**  
Production Supervisor

**Jodi Morin, KA1JPA**  
Assistant Production Supervisor

**Maty Weinberg, KB1EIB**  
Production Coordinator

**David Pingree, N1NAS**  
Senior Technical Illustrator

**Janet Rocco, W1JLR**  
Advertising Sales Manager

**Bob Inderbitzen, NQ1R**  
Product Development Manager

**Yvette Vinci, KC1AIM**  
Marketing and Sales Manager

**Steve Ewald, WV1X**  
Field Organization Supervisor

**Eric Casey, KC2ERC**  
Convention and Event Coordinator

**30 Build Your Own Open-Wire Line**  
Robert J. Zavrel, Jr., W7SX

**34 Using Integrated Circuits to Add Propagation Delays**  
Klaus Spies, WB9YBM

**36 "Leaky" Antenna Switches**  
Ellwood (Woody) Brem, K3YV

**38 Batteries for the Elecraft KX3 and Other Low-Power Radios**  
Eliot Mayer, W1MJ

**42 Product Review**  
Mark Wilson, K1RO  
Xiegu G90 HF Transceiver;  
SOTABEAMS Wolfwave Audio  
Processor; Inexpensive Antenna  
System Tuning Indicators



42

**60 A Grid DXpedition in the Upper Peninsula**  
Dan Brandner, N9DJB

**64 How the Ionosphere Was Confirmed**  
Robert H. Welsh, N3RW

**67 Eclectic Tech: A New Technical Podcast for Amateur Radio!**

**68 The Saga of Clipperton Island**  
Allison McLellan

**72 Nominations Now Being Accepted for 2020 McGan Silver  
Antenna Award for Excellence in Public Relations**

**80 The 2019 IARU HF World Championship Results**  
Bob Raymond, WA1Z

**87 The April 2020 ARRL Rookie Roundup — Phone**

**93 A Look Back: May 1970**



## Columns

Celebrating Our Legacy.....	99
Classic Radio.....	100
Close Up.....	41
Contest Corral.....	79
Correspondence.....	24
The Doctor is In.....	55
Eclectic Technology.....	59
Happenings.....	73
Hints & Hacks.....	57
How's DX?.....	86
Member Spotlight.....	13
Public Service.....	77
Up Front.....	20
The World Above 50 MHz.....	84
100, 50, and 25 Years Ago.....	102

## Digital and Mobile Editions

ARRL members can access the digital edition via a link at [www.arrl.org/qst](http://www.arrl.org/qst), download our iOS app from the iTunes Store, and download our Android app from the Google Play Store.

## Departments

Amateur Radio Band Chart.....	9
ARRL Section Managers.....	16
Certificate of Code Proficiency Recipients.....	88
Convention and Hamfest Calendar.....	89
Feedback.....	90
Field Organization Reports.....	78
Guide to ARRL Member Benefits.....	14
Ham Ads.....	140
Index of Advertisers.....	142, 143
New Books.....	90
New Products.....	54
Officers, Division Directors, and Staff.....	15
QST Cover Plaque Award.....	71
Silent Keys.....	103
Special Event Stations.....	83
Strays.....	101, 103
VEC Honor Roll.....	92
WIAW Qualifying Runs.....	88
WIAW Schedule.....	91
WIAWs QSL File.....	28

## Write for QST

[www.arrl.org/qst-author-guide](http://www.arrl.org/qst-author-guide)  
email: [qst@arrl.org](mailto:qst@arrl.org)



## Our Cover

The open-wire feed line on our cover is based on Robert Zavrel's, W7SX, step-by-step construction. His rugged open-wire line holds up in difficult weather and works great even under high SWR conditions. For Robert's full instructions — which can be adapted to suit your specifications and the tools you have available — see his article, "Build Your Own Open-Wire Line," on page 30 of this issue.



QST (ISSN:0033-4812) is published monthly as its official journal by the American Radio Relay League, Inc., 225 Main St., Newington, CT 06111-1400, USA. Canada Post: Publications Mail Agreement #90-0901437. Canada returns to be sent to IMEX Global Solutions, 1501 Morse Ave., Elk Grove Village, IL 60007.

**POSTMASTER:** Send address changes to: QST, 225 Main St., Newington, CT 06111-1400, USA. Canada Post: Publications Mail Agreement #90-0901437. Canada returns to be sent to IMEX Global Solutions, 1501 Morse Ave., Elk Grove Village, IL 60007.

**US & Possessions:** Membership in the ARRL, including a 1-year subscription to QST, is available to individuals at \$49. Licensed radio amateurs age 21 and under and the eldest licensee in the household may qualify for the rate of \$25. Life Membership, including a subscription to QST is available at \$1,225.\* Membership includes \$21 per year for subscription to QST. Membership and QST cannot be separated. Libraries and institutions, \$49 per year. Single copies \$6.95.

## International

To compensate for additional postage for mailing outside the US, the following rates apply:

**Canada:** Membership in the ARRL, including a 1-year subscription to QST, \$62, payable in US funds. Life Membership, including a subscription to QST is available at \$1,550.\* Libraries and institutions, \$62 per year.

**All Other Countries:** Membership in the ARRL, including a 1-year subscription to QST, \$76, payable in US funds. Life Membership, including a subscription to QST, is available at \$1,900.\* Libraries and institutions, \$76 per year.

Membership without QST is available to the immediate family of a member living at the same address, and to anyone who is legally blind, for \$10 per year.

Foreign remittances should be by international postal or express money order or bank draft negotiable in the US and for an equivalent amount in US funds.

Membership in the ARRL, including a 1-year subscription to Digital QST only, is available to Canadian and International members at \$49.

Copyright © 2020 by the American Radio Relay League Inc. Title registered at the US Patent Office. International copyright secured. All rights reserved. Quedan reservados todos los derechos. Printed in the USA.

QST®, DXCC®, VUCC®, DX Century Club®, ARES®, Amateur Radio Emergency Service®, Logbook of The World®, LoTW®, and ARRL, the national association for Amateur Radio® are registered trademarks of the American Radio Relay League, Inc.

The ARRL and QST in no way warrant the products described or reviewed herein.

QST is available to blind and physically handicapped individuals from the Library of Congress, National Library Service for the Blind and Physically Handicapped. Call 1-800-424-8567 or go to [www.loc.gov/nls/](http://www.loc.gov/nls/).

Indexed by Applied Science and Technology Index, Library of Congress Catalog Card No. 21-9421.

\*Payment arrangements available. Please write for details.

In order to ensure prompt delivery, we ask that you periodically check the address information on your mailing label. If you find any inaccuracies, please contact the Circulation Department at [circulation@arrl.org](mailto:circulation@arrl.org) or 860-594-0200 immediately. Thank you for your assistance.

Reprints and permissions: [permission@arrl.org](mailto:permission@arrl.org)  
Details of our Online Privacy Policy can be found at [www.arrl.org/online-privacy-policy](http://www.arrl.org/online-privacy-policy).

Telephone: 860-594-0200  
Fax: 860-594-0259

# WIRE ANTENNAS for BALUNS & UNUNS

# LDG

Not sure which wire antenna is right for your LDG Balun or Unun? Check out this handy chart of popular wire antennas. Just add an LDG tuner in your shack with any of these antennas and work mostly 80-10 meters with good results. Visit [www.ldgelectronics.com](http://www.ldgelectronics.com) to learn more and see our full line of Amateur accessories.

**\$30 ea.** | 200 Watts PEP  
1.8-30MHz

40M DIPOLE

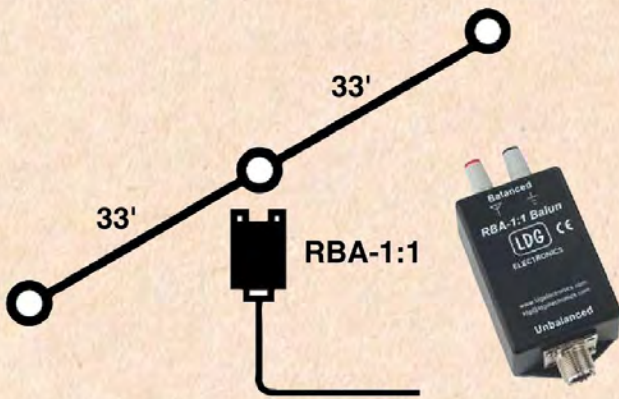

G5RV DIPOLE

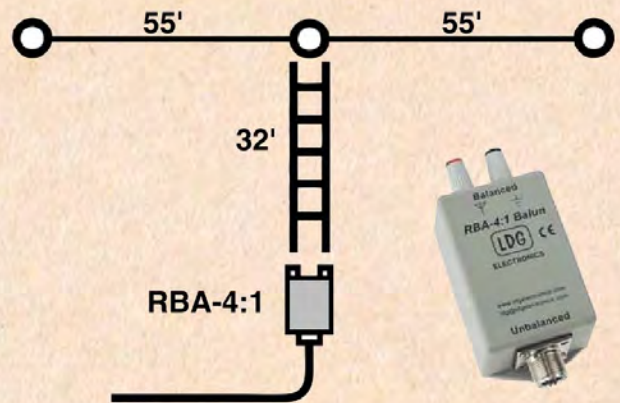

OFF CENTER FED WINDHAM

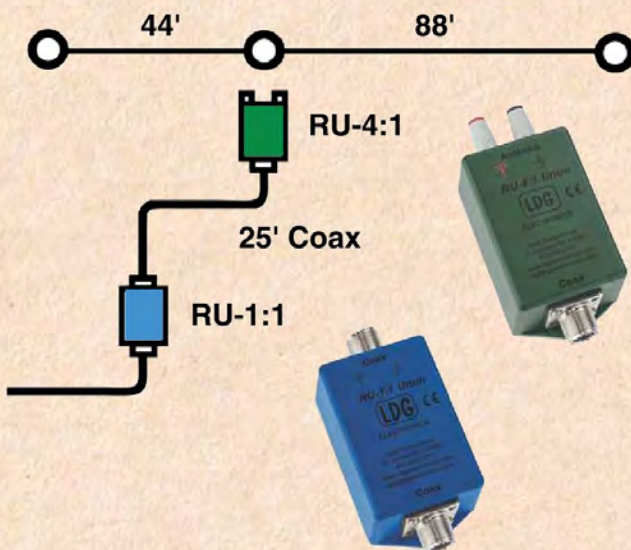

END FED LONG WIRE

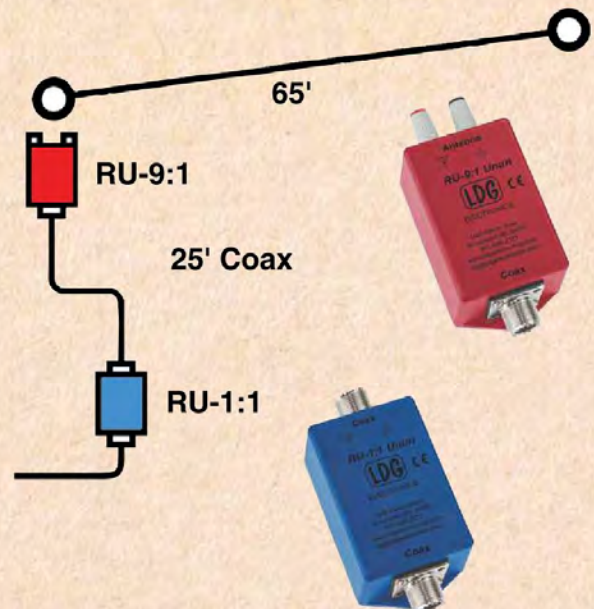



# The SteppIR Advantage

## PROBLEM SOLVED!

Yagi antennas are basically single frequency devices that work well only over a very narrow range, typically 0.5% change in frequency. Fixed length yagis compensate by using a variety of techniques, all of which result in serious degradation of performance, especially in Front to Rear rejection, and added complexity, size, and weight. Dipoles have a much broader bandwidth but still cannot cover the entire 80m and 40m bands and maintain a low SWR (<1.5:1). Our patented solution is to simply adjust all of the antenna elements to the optimal length for the desired frequency with none of the compromises in performance that all fixed antennas require. This is accomplished remotely using an electronic controller that can automatically follow the radios' frequency. SteppIR antennas enjoy optimal performance on all frequencies within their specified frequency range (varies by model), and that includes non-ham radio frequencies as well!

### THE INHERENT ADVANTAGES OF A STEPPIR:

#### Create/Modify Mode

The create modify mode allows the user to change the length of each individual antenna element on all bands of operation -and frequencies outside the ham bands as well - and then save the new antennas to memory. This can be incredibly useful to "tune" out potential objects that may be causing interaction with the SteppIR antenna, or to create your own custom antenna designs.

#### 180 Degree Mode

The 180 degree mode feature is one of the most popular among SteppIR owners. For our Yagi antennas, this feature allows a user to electrically "rotate" the antenna from the forward beam heading, to the reverse (180 degrees) beam heading, with a click of a button - the entire process takes approximately 2 seconds.

#### Bi-Directional Mode

The bi-directional mode works similarly to the 180 function, except when enabled, the Yagi antenna will now be operating with gain in both directions - forward and backwards, simultaneously!

#### Retract Elements

With a touch of a button, SteppIR antennas can be fully retracted into their housing, which helps to protect the most valuable part of the antenna during extreme weather events.

#### Emergency Communications

Many times, emergency communications occur outside the standard amateur radio allocated bands of operation. All SteppIR antennas are optimal within the entire scope of their specified frequency range.

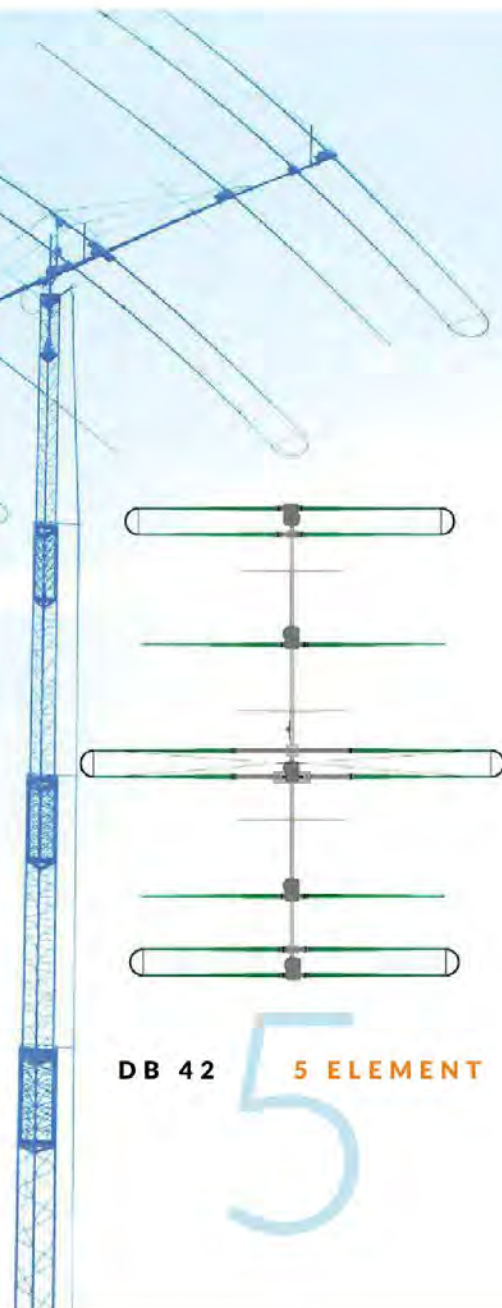

# DIAMOND ANTENNA

diamondantenna.net

When it comes to quality and performance, DIAMOND ANTENNA is the worldwide leader in VHF/UHF base and mobile antennas.

DIAMOND ANTENNAS help you get the most out of your on-air experience.

For all your base station and repeater needs, DIAMOND has an antenna that will work for you.

You've tried the rest, now own the best!

Here is a small sample of our wide variety of antennas

Model	Bands	Length Ft.	Max Pwr. Rating	Conn.
<b>Dualband Base Station/Repeater Antennas</b>				
X700HNA (4 section)	2m/70cm	24	200	N
X510HD (3 Section)	2m/70cm	17.2	330/250	UHF or N
X300A (2 Section)	2m/70cm	10	200	UHF or N
X200A (2 Section)	2m/70cm	8.3	200	UHF
X50A (1 Section)	2m/70cm	5.6	200	UHF or N
X30A (1 Section)	2m/70cm	4.5	150	UHF
<b>Monoband Base Station/Repeater Antennas</b>				
F23H (3 Section)	144-174 MHz (W/ Cut Chart)	15	350	UHF
F22A (2 Section)	2m	10.5	200	UHF
CP22E (Aluminum)	2m	8.9	200	UHF
F718A (Coax Element)	70cm	15	250	N
<b>Dualband Mobile Antennas</b>				
SG7900A	2m/70cm	62.2 in.	150	UHF or NMO
SG7500A	2m/70cm	40.6 in.	150	UHF or NMO
NR770H Series	2m/70cm	38.2 in.	200	UHF or NMO
MR77 Series	2m/70cm	20 in.	70	Mag Combo
AZ504FXH	2m/70cm	15.5 in.	50	UHF
AZ504SP	2m/70cm	15.5 in.	50	UHF
NR7900A	2m/70cm	57 in.	300/250	UHF
<b>Monoband Mobile Antennas</b>				
NR22L	2m	96.8 in.	100	UHF
M285	2m	52.4 in.	200	UHF or NMO

## X700HNA Special Features:

- Heavy duty fiberglass radomes
- Four-section assembly
- Overlapping outer shells for added strength
- Stainless steel mounting hardware & radials
- Strong waterproof joint couplings
- Type-N cable connection
- Wideband performance
- Highest gain Dual-band Base Antenna!

The Standard By Which All Others Are Judged



Diamond Antenna is a division of RF Parts Company

# US Amateur Radio Bands

Operator license classes: **E** = Amateur Extra **A** = Advanced **G** = General **T** = Technician **N** = Novice  
 CW operation is permitted throughout all amateur bands. Except as noted, all frequencies are in megahertz (MHz).

■ = RTTY, data, phone, image   
 ■ = USB phone, RTTY, data and CW   
 ■ = RTTY and data   
 ■ = phone and image  
■ = SSB phone   
⋮ = CW only

## LF – Low Frequency band

**2200 Meters (135 kHz) E,A,G**  
**1 W EIRP maximum**



## MF – Medium Frequency bands

**630 Meters (472 kHz) E,A,G**  
**5 W EIRP max, except in Alaska within 496 miles of Russia where the limit is 1 W EIRP**



**160 Meters (1.8 MHz) E,A,G**

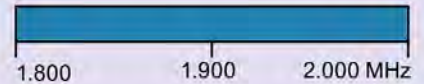

Amateurs wishing to operate on **2200 or 630 meters** must first register with the Utilities Technology Council online at <https://utc.org/plc-database-amateur-notification-process/>. You need only register once for each band.

## HF – High Frequency bands

**80 Meters (3.5 MHz) E,A,G,T,N**

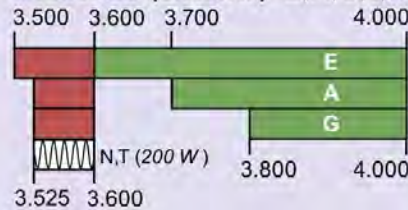

**60 Meters (5.3 MHz) E, A, G (100 W)**

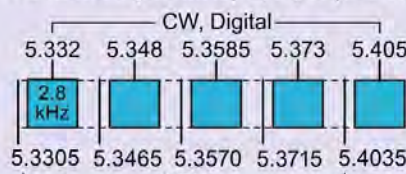

Gen, Adv, and Extra licensees may operate on a secondary basis with a maximum ERP of 100 W maximum.

**40 Meters (7 MHz) E,A,G,T,N**

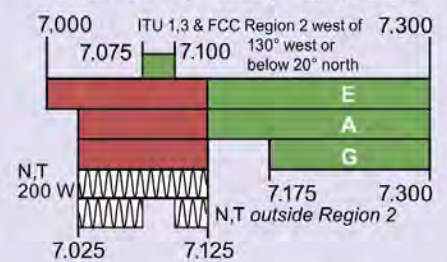

**30 Meters (10.1 MHz) E,A,G**

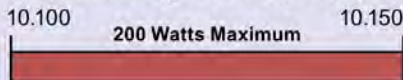

**20 Meters (14 MHz) E,A,G**

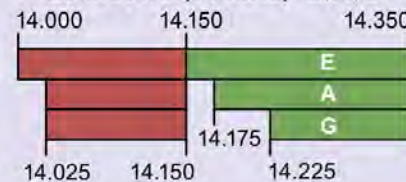

**17 Meters (18 MHz) E,A,G**

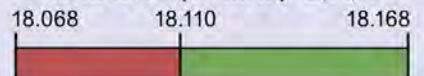

**15 Meters (21 MHz) E,A,G,T,N**

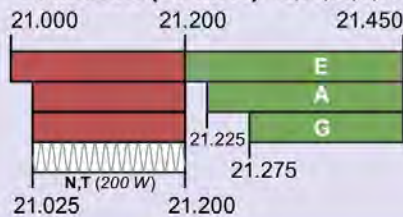

**12 Meters (24 MHz) E,A,G**

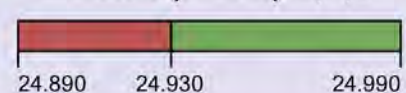

**10 Meters (28 MHz) E,A,G,T,N**

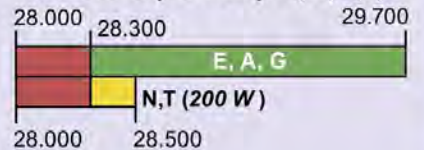

## VHF – Very High Frequency bands

**6 Meters (50 MHz) E,A,G,T**

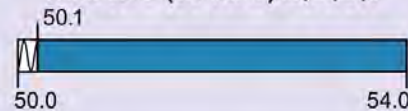

**2 Meters (144 MHz) E,A,G,T**



**1.25 Meters (222 MHz) E,A,G,T,N**

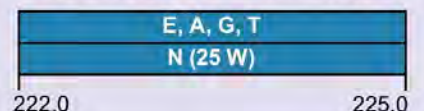

## UHF – Ultra High Frequency bands

**70 cm (420 MHz) E,A,G,T**

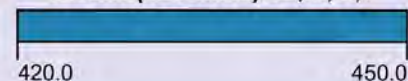

**33 cm (902 MHz) E,A,G,T**



**23 cm (1240 MHz) E,A,G,T,N**

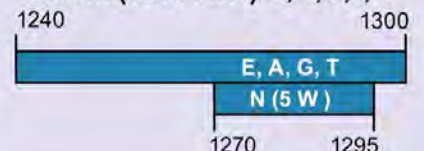

## SHF&EHF – Super and Extremely High Frequency bands

All licensees except Novices are authorized all modes on the following frequencies:

2300-2310 MHz	3300-3500 MHz	10.0-10.5 GHz	47.0-47.2 GHz	122.25-123.0 GHz	241-250 GHz
2390-2450 MHz	5650-5925 MHz	24.0-24.25 GHz	76.0-81.0 GHz	134-141 GHz	All above 275 GHz

See [www.arrl.org/band-plan](http://www.arrl.org/band-plan) for detailed band plans.

Copyright © ARRL 2019  
 OTAbands rev. 11/8/2019

The First Choice of Hams Around the World!

# hy-gain® HF Beams

...are stronger, lighter, have less wind surface and last years longer.

Why? hy-gain uses durable tooled components – massive boom-to-mast bracket, heavy gauge element-to-boom clamps, thick-wall swaged tubing – virtually no failures!

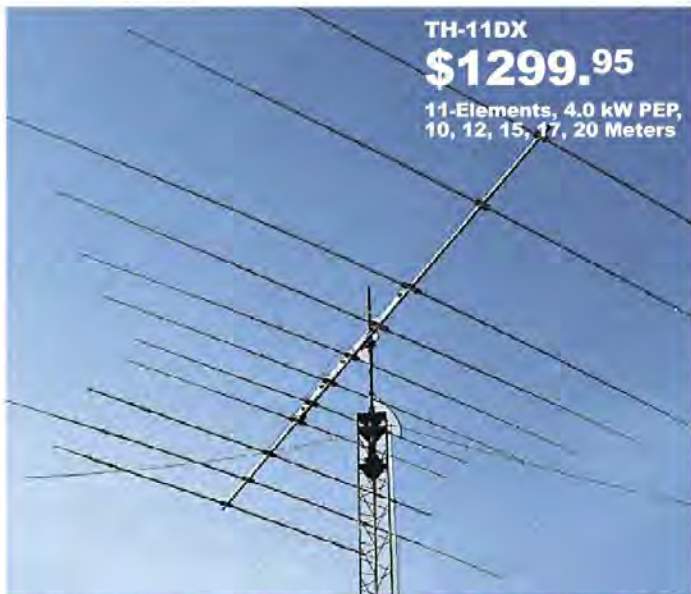

### TH-11DX, \$1299.95. 11-element, 4.0 kW PEP, 10, 12, 15, 17, 20M

The choice of top DXers. With 11-elements, excellent gain and 5-bands, the super rugged TH-11DX is the "Big Daddy" of all HF beams! Handles 2000 Watts continuous, 4000 Watts PEP. Every part is selected for durability and ruggedness for years of trouble-free service.

Features a low loss logperiodic driven array on all bands with mono-band reflectors, BN-4000 high power balun, corrosion resistant wire boom support, hot dipped galvanized and stainless steel parts. Stainless steel hardware and clamps are used on all electrical connections.

### TH-7DX, \$999.95. 7-element, 1.5 kW PEP, 10, 15, 20 Meters

7-Elements gives you the highest average gain of any hy-gain tri-bander! Dual driven for broadband operation without compromising gain. SWR less than 2:1 on all bands. Uniquely combining monoband and

trapped parasitic elements give you an excellent F/B ratio. Includes hy-gain's diecast aluminum, rugged boom-to-mast clamp, heavy gauge element-to-boom brackets, BN-86 balun. For high power, upgrade to BN-4000.

### Compact 3-element 10, 15, 20 Meter Tri-Bander

For limited space...Installs anywhere...14.75 ft turning radius... weighs 21 lbs...Rotate with CD-45II, HAM-IV



Fits on light tower, suitable guyed TV pole, roof tri-pod

TH-3JRS, \$419.95. hy-gain's most popular 3-element 10, 15, 20 Meter tribander fits on most lots! Same top performance as the full power TH3MK4 in a compact 600 watt PEP design.

Excellent gain and F/B ratio let you compete with the "big guns".

Tooled manufacturing gives you hy-gain durability with 80 MPH wind survival.

### TH-5MK2, \$879.95. 5-element, 1.5 kW PEP, 10,15, 20 Meters

The broadband five element TH5-MK2 gives you outstanding gain. Separate air dielectric Hy-Q™ traps let you adjust for maximum F/B ratio on each band.

Also standard is hy-gain's exclusive BetaMATCH™, stainless steel hardware and compression clamps and BN-86 balun.

### TH-3MK4, \$549.95. 3-element, 1.5 kW PEP, 10,15, 20 Meters

The super popular TH-3MK4 gives you the most gain for your money in a full-power, full-size durable hy-gain tri-bander!

You get an impressive average gain and a whopping average front-to-back ratio. Handles a full 1500 Watts PEP. 95 MPH wind survival.

Fits on average size lot with room to spare – turning radius is just 15.3 feet.

Four piece boom is ideal for DXpeditions. Rotates with CD-45II or HAM-IV rotator.

Features hy-gain BetaMatch™ for DC ground, full power Hy-Q traps, rugged boom-to-mast bracket and mounts on standard 2" O.D. mast. Stainless steel hardware. BN-86 balun recommended.

### TH-2MK3, \$449.95. 2-element, 1.5 kW PEP, 10,15, 20 Meters

The 2-element TH-2MK3 is hy-gain's most economical full power (1.5kW PEP) full size tri-bander.

For just \$339.95 you can greatly increase your effective radiated power and hear far better!

Ruggedly constructed, top-performing, compact 6 foot boom, tight 14.3 foot turning radius. Installs almost anywhere. Rotate with CD-45II or HAM-IV. BN-86 balun recommended.

### EXP-14, \$699.95. 4-element, 1.5 kW PEP, 10,15, 20 Meters

Revolutionary 4-element compact tri-bander lets you add 40 or 30 Meters! Has 14 foot boom and tight 17.25 feet turning radius. Fits on roof tri-pod, mast or medium duty tower.

hy-gain's patented broadbanding Para Sleeve gives you less than 2:1 VSWR. 1.5kW PEP.

BetaMATCH™ provides DC ground to eliminate static. Includes BN-86 balun. Easily assembled.

Truly competitive against giant tri-banders at half the cost!

QK-710, \$199.95. 30/40 Meter option kit for EXP-14.

## Tooled Manufacturing... Highest Quality Materials

1. hy-gain's famous super strong tooled die cast Boom-to-Mast Clamp
2. Tooled Boom-to-Element Clamp
3. Thick-wall swaged aluminum tubing

Tooled manufacturing is the difference between hy-gain antennas and the others -- they just don't have it (it's expensive!).

Die-cast aluminum boom-to-mast bracket and element-to-boom compression clamps are made with specially tooled machinery.

hy-gain antennas feature tooled swaged tubing that is easily and securely clamped in place. All tubing is deburred and cleaned for smooth and easy assembly.

Durable precision injection molded parts.

hy-gain antennas are stronger, lighter, have less wind surface area, better wind survival, need no adjustments, look professional and last years longer.



Model No.	No. of elements	avg gain dBd	avg F/B dB	MaxPwr watts PEP	Bands Covered	Wind sq. ft. area	Wind (mph) Survival	Boom feet	Longest Elem. (ft)	Turning radius (ft)	Weight (lbs.)	Mast dia O. D. (in.)	Recom. Rotator	Sugg. Retail
TH-11DX	11			4000	10, 12, 15, 17, 20	12.5	100	24	37	22	88	1.9-2.5	T2X	\$1299.95
TH-7DX	7	For Gain and F/B ratio-See...		1500	10, 15, 20	9.4	100	24	31	20	75	1.5-2.5	HAM-IV	\$999.95
TH-5MK2	5			1500	10, 15, 20	7.4	100	19	31.5	18.42	57	1.5-2.5	HAM-IV	\$879.95
TH-3MK4	3	www.hy-gain.com hy-gain catalog Call toll-free 800-973-6572		1500	10, 15, 20	4.6	95	14	27.42	15.33	35	1.9-2.5	CD-45II	\$549.95
TH-3JRS	3			600	10, 15, 20	3.35	80	12	27.25	14.75	21	1.25-2.0	CD-45II	\$419.95
TH-2MK3	2			1500	10, 15, 20	3.25	80	6	27.3	14.25	20	1.9-2.5	CD-45II	\$449.95
EXP-14	4			1500	10, 15, 20 opt.30/40	7.5	100	14	31.5	17.25	45	1.9-2.5	HAM-IV	\$699.95



Antennas, Rotators & Towers 308 Industrial Pk Rd, Starkville, MS 39759 USA  
Sales/Tech: (662) 323-9538 ■ FAX: (662) 323-5803 Open 8-4:30 CST, Mon.-Fri.

Add shipping. Prices and specifications subject to change. ©2016 Hy-Gain.

TH11DX\_101408\_4C\_QST\_0908190S

QUALITY AMATEUR RADIO PRODUCTS FROM

**INRAD** 

**New!**

**MAT-TUNER from INRAD**  
**6 Great NEW Automatic Antenna Tuners**

**MAT-TUNER**  
 prices from  
**\$159.95**



Sleek machined aluminum cases, quality PC boards.  
 Control tuners from radio front panel with included  
 interface cables for Icom, Kenwood, and Yaesu transceivers.

Broad matching range for high input SWR is better  
 than internal transceiver automatic antenna tuners,  
 120 watts RF power handling, 2 year warranty.



**DESK**  
**MICS**  
**\$138-158**

**INRAD DESK MICROPHONES**

THE INRAD DESK MICROPHONE SYSTEM IS THE  
 NEW STANDARD FOR QUALITY AUDIO ON HF.  
 Excellent audio doesn't have to cost hundreds  
 of dollars. Prices from \$138 to \$158. QST review:  
 January 2018.

**W1**  
**HEADSET**  
**\$179**



**INRAD W1 HEADSET**

THE INRAD W1 HEADSET IS THE NEW HAM  
 RADIO STANDARD. Great comfort. Great audio. Great price.  
 THOUSANDS IN USE WORLDWIDE QST review: May 2019

**VIBROPLEX AND  
 BENCHER CW Keys** –  
 The BENCHER BY-1 is the  
 best selling iambic paddle in  
 Amateur Radio! Iambic  
 paddles, straight keys, bugs,  
 single lever paddles,  
 accessories and more.



**BENCHER, inc.**



**EASY-ROTOR-CONTROL**

USB control of 90 different rotators. Point and click  
 with your mouse. Interfaces with most popular ham  
 software. Kit and assembled versions start at only \$99.  
 AZ/EL controllers also available. QST review: Nov. 2014.

**DXPatrol** is a tiny SDR covering 100 kHz-2  
 GHz that can be used with Windows, Mac, Linux,  
 or Android. Not an 8-bit dongle! Full featured  
 receiver. Want to add a panadaptor to  
 your HF transceiver? Do it with DXPatrol.  
 Great price at only \$99.95!



**\$99.95**

**spiderbeam**  
 high performance lightweight antenna

THE SPIDERBEAM 40FT HD FIBERGLASS  
 POLE HAS NO EQUAL IN HAM RADIO  
 One pole, many uses, made to withstand  
 years of portable or permanent  
 installation.



**SPIDERBEAM HD FIBERGLASS POLES**  
 40 ft - \$109 and \$119 / 60 ft - \$279 / 72 ft - \$479 / 85 ft -  
 \$599. QST review: Feb. 2010

**SPIDERBEAM ROTATABLE ALUMINUM MASTS** - support  
 for 13 to 26 lbs antenna weight. 33 ft - \$459 / \$485, 41 ft  
 \$509, 47 ft \$639, 49 ft \$575, 60 ft \$749. Guy hardware,  
 rotator adapters, other accessories available. QST review:  
 May 2015.

[www.spiderbeam.us](http://www.spiderbeam.us)

**VIBROPLEX**

**(865) 309-5073**

[www.vibroplex.com](http://www.vibroplex.com)

# Array Solutions

Your Source for Outstanding Radio Products



## Professional Grade Equipment from Array Solutions

### Hamation Station Automation

Hamation remote and Local Station Control products allow you to automatically or manually select antennas, bandpass filters, and control accessories. Accessories can be StackMatches, Antenna switches, antenna phasing systems, SteppIR controller, turning radios on and off, etc. All of this can be done directly from the Ethernet as well!

Wiring are simple phone cables that daisy chain to all the devices. Wireless control is also available to your tower-located switches. Call us to learn how to set up simple or complex systems. Below is a simple basic system that can switch antennas as you change bands. We can interface to any radio CAT port, not just RS232.



A more complex system could be a SO2R contest station as shown.



### The Shared Apex Loop Array™!

Capture the whole band or the whole HF spectrum at once with the Shared Apex Loop Array 2nd Generation. Can be remote controlled over the internet or in your station. 8 directions of directivity.

The Shared Apex Loop Array™ is a revolutionary receiving antenna that will change the way that you listen to the radio! The patented design provides performance in a size and over a wide range of frequencies that will please both the rag-chewer and DXer alike.

Three models to choose from:

- AS-SAL-30 - optimized for VLF, BCB, 1.8-10 MHz
- AS-SAL-20 - optimized for BCB, and 1.8-30 MHz
- AS-SAL-12 - optimized for 3-30 MHz



### StackMatch

The original, not the imitations. For phasing 2, 3, 4 and even 6 antennas. Also it can be used to combine vertical and horizontal polarized antennas to diminish fading.



### PowerMaster II



RF Power and SWR meter. Couplers for 3 kW, 10 kW or higher available for HF/6 m. VHF and UHF couplers for 1.5 kW. You can connect up to 5 couplers to the display to monitor RF power on different TX lines.



OM Power Amplifiers,  
The New RF Power  
Benchmark!



### OM2000A+ – OM2000+

The **OM2000A+** is the lightest and smallest 2000 W fully automatic HF/6 m power amplifier in the market. Its manual tuning version, the **OM2000+**, is our affordable unmatched best-seller.

**Frequency coverage:**

Amateur bands 1.8 – 29.7 MHz including WARC + 50 MHz

**Power output:** 2000+ W in SSB/CW on HF bands, 1500 W in RTTY  
1500 W CW/SSB on 50 MHz



Coming soon the new **OM2501HF/A** and **OM4001HF/A** amplifiers. Additional features and functionality. Watch our website for details and availability.

### Tubes



**GU-74b**  
**4CX1000A**  
**4CX1500B**

Tested singles and matched pairs available, 1 year warranty

### Amplifier Repairs

- We service ACOM, OM Power, Alpha, ETO, and most brands.
- Fast turnaround, and communication with our test Technicians
- Service report and test data included
- Tube testing for some common tubes  
[www.arrayolutions.com/amplifier-service](http://www.arrayolutions.com/amplifier-service)

### EMTRON ES-1A

An innovative radio, amp, and antenna switch. Routes one of two radios to a single amplifier and then to two antenna outputs. Solves the problem of tedious manual hookups if you have more than one radio. Also routes PTT and ALC lines. Introductory pricing \$195.00

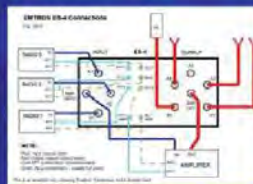

### Switches for Six Antennas



**5kW - DC to 6m**  
**RATPAK – 1x6**  
Choice of Multiple Controllers  
**SIXPAK – 2x6**



### Surge Arrestors

**AS-302, AS-303** Coaxial cable arrestors. DC to 500 MHz, N-type or SO-239 connectors. **AS-300SB** Stacking fixture available. **AS-309H**, ladder line arrestor. All have static bleed function. **AS-8SP, AS-12SP** and **AS-16SP** control cable arrestors. Protect your rotator's and other control cables.



### Baluns & RF Transformers

Ratios 1:1, 1:2, 2:1,4:1 and more. RF line isolators. Ratings 3, 5, 10 kW+. Get the most out of your antenna by stopping the coaxial cable from becoming part of it.



[www.arrayolutions.com](http://www.arrayolutions.com)

2611 North Beltline Rd., Suite 109  
Sunnyvale, Texas 75182 USA  
sales@arrayolutions.com  
Phone 214-954-7140 Fax 214-954-7142

Check our Website for more new products!

Array Solutions' products are in use at top DX and Contest stations worldwide as well as commercial and governmental installations. We provide RF solutions to the DoD, FEMA, Emcomm, UN, WFO, FAA and the State Dept. for products and installation of antennas systems, antenna selection, filtering, switching and grounding. We also offer RF engineering and PE consulting services.

## Member Spotlight

# Edward Finnegan, K9ECF

Edward Finnegan, K9ECF, takes amateur radio to the skies with his work as an American Airlines pilot and as a certified aviation instructor and check airman.

### Taking Flight

Ed is a former Army aviator, having received his Airline Transport Pilot certificate with over 18,000 hours of flight time. While on active duty, he flew helicopters and fixed-wing aircraft on reconnaissance missions along the sensitive borders of the Republic of Korea and West Germany. It was during this time that he first became interested in amateur radio, specifically HF radios.

He left active duty to fly for American Airlines in 1990, but his interest in amateur radio continued. He earned his Technician license in November 2012, and upgraded to General only 1 month later.

### Radio at 37,000 Feet

Ed said that his favorite aspect of amateur radio is that there are so many directions you can take with the hobby, and it can overlap with so many other interests. "There seems to be something for everyone," he said, "whether it's analog or digital, old or new technology, or operating on the ground or in the air."

Naturally, Ed combined his interests in amateur radio with his love of flying, saying he enjoys making "aeronautical mobile contacts." He particularly likes making overhead contacts with his brother, Tom, K3TRF, whom Ed convinced to get his license.

Workload permitting and recognizing that his first priority is safely flying the aircraft, Ed even makes contacts while airborne in the B-737. Using his



Edward Finnegan, K9ECF.

altitude to his advantage, he is able to act as a relay station for various maritime mobile service nets. "You can hear a lot at 37,000 feet!" he said.

Ed is not alone in enjoying the natural intersection of these two worlds. AirVenture Oshkosh is the largest annual gathering of aviators, but it is also a great place to celebrate the overlap of aviation and ham radio. Many pilots carry handheld radios for various backup communications and for talking with other hams as they fly overhead.

As a board member and Chairman of the Safety Committee for Warbirds of America, Ed participated in their EAA 2019 AirVenture exhibit, where he helped Warbirds of America set up a special event radio station (W9W), highlighting their contribution to the world event and to ham radio.

### Finnegan Aviation Services

Ed is a certified flight instructor and ground instructor with primary, multi-

engine, and instrument ratings. He flies a variety of aircraft within the warbird community, and has recently been authorized by the FAA to provide practical test services to general aviation.

With these certifications, Ed was able to start Finnegan Aviation Services, LLC. in support of the FAA's Vintage and Surplus Military Aircraft program, Ed is a designated specialty aircraft examiner. Through Finnegan Aviation Services, he acts as a check airman for World War II-, Korean War-, and Vietnam War-era aircraft, "which I also fly for enjoyment on my days off." He ensures that a pilot's training and skills are up to FAA standards before they are permitted to fly the aircraft by themselves. He is qualified to conduct specialized instruction, proficiency and competency checks, and ferry services for maintenance and relocation.

### Homebrewing

Ed still uses the first radio he purchased, an Icom-746, and enjoys DIY antenna building. Being a pilot, his first homebrew experience was with a homebrew ground-plane antenna for the aviation band, and a homebrew ground-plane antenna for 10 to 11 meters. Surprised that they worked as well as they did, Ed tried something a little bigger, building a 33-foot homebrew vertical.

### Giving Back

Ed feels that it is important for hams to give back to the community. He is a RACES volunteer, supporting the McHenry County, Illinois, Emergency Management Agency in their emergency communications division. You can catch him on the 6 – 80 meter bands.

# Guide to Member Benefits



## Join or Renew

[www.arrl.org/join](http://www.arrl.org/join)

## Donate

[www.arrl.org/donate](http://www.arrl.org/donate)

## Benefits

[www.arrl.org/benefits](http://www.arrl.org/benefits)

## Shop

[www.arrl.org/shop](http://www.arrl.org/shop)

### ARRL Online | [www.arrl.org/myARRL](http://www.arrl.org/myARRL)

Create an online ARRL Member account, and get access to members-only benefits. Register at [www.arrl.org/myARRL](http://www.arrl.org/myARRL). Already registered? Log in at the top of the ARRL website.

#### Magazines | [www.arrl.org/qst](http://www.arrl.org/qst) and [www.arrl.org/ota](http://www.arrl.org/ota)

Members in the US receive a choice of print magazine: *QST*, ARRL's membership journal (12 monthly issues), or *On the Air*, our new magazine for new and beginner-to-intermediate-level radio amateurs (6 bimonthly issues). All members can access the digital editions of both *QST* and *On the Air* from a web browser and apps available for iOS, Android, and Kindle Fire devices. Members need a valid ARRL account to access the digital editions of *QST* and *On the Air*, Archives and Periodicals Search, and the Product Review Archive.

#### E-Newsletters | [www.arrl.org/myARRL](http://www.arrl.org/myARRL)

Subscribe to the weekly **ARRL Letter** and a variety of other ARRL e-newsletters and announcements: ham radio news, radio clubs, public service, contesting, and more!

#### Email Forwarding Service

Email sent to your **arrl.net** address will be forwarded to any email account you specify.

### Technical Information Service | [www.arrl.org/tis](http://www.arrl.org/tis)

Call or email our expert ARRL Technical Information Service specialists for answers to all your technical and operating questions. This service is FREE to ARRL members.

### Advocacy | [www.arrl.org/regulatory-advocacy](http://www.arrl.org/regulatory-advocacy)

ARRL supports legislation and regulatory measures that preserve and protect meaningful access to the radio spectrum. Our **ARRL Regulatory Information Branch** answers member questions concerning FCC rules and operating practices. **ARRL's Volunteer Counsel** and **Volunteer Consulting Engineer** programs open the door to assistance with antenna regulation and zoning issues.

### Group Benefits\* | [www.arrl.org/benefits](http://www.arrl.org/benefits)

■ **ARRL Ham Radio Equipment Insurance Plan**

■ **Liberty Mutual Auto and Home Insurance**

\*US only

### Find...

...a License Exam Session | [www.arrl.org/exam](http://www.arrl.org/exam)

...a Licensing Class | [www.arrl.org/class](http://www.arrl.org/class)

...a Radio Club (ARRL-affiliated) | [www.arrl.org/clubs](http://www.arrl.org/clubs)

...a Hamfest or Convention | [www.arrl.org/hamfests](http://www.arrl.org/hamfests)

### Interested in Becoming a Ham?

[www.arrl.org/newham](http://www.arrl.org/newham)

[newham@arrl.org](mailto:newham@arrl.org) | Tel. 1-800-326-3942 (US)

### Connect with ARRL

**ARRL, the national association for Amateur Radio®**

225 Main Street, Newington, CT 06111-1400 USA

1-860-594-0200, Mon. – Fri. 8 AM to 5 PM ET except holidays

FAX 1-860-594-0259, email [hqinfo@arrl.org](mailto:hqinfo@arrl.org)

Contact ARRL: [www.arrl.org/contact-arrl](http://www.arrl.org/contact-arrl)



Website: [www.arrl.org](http://www.arrl.org)

Facebook: [@ARRL.org](https://www.facebook.com/ARRL.org)

Twitter: [@arrl](https://twitter.com/arrl), [@w1aw](https://twitter.com/w1aw), [@arrl\\_ares](https://twitter.com/arrl_ares)

Instagram and Instagram TV: [@arrlhq](https://www.instagram.com/arrlhq)

YouTube: [ARRLHQ](https://www.youtube.com/ARRLHQ)

LinkedIn: <https://www.linkedin.com/company/american-radio-relay-league/>

**Book of the Month!**

**ARRL's Best of The Doctor is In**

**20% OFF Online**

[www.arrl.org/shop](http://www.arrl.org/shop)

ARRL Item No. 0741 Ends March 31, 2020

### The American Radio Relay League, Inc.

ARRL, the national association for Amateur Radio® in the United States: supports the awareness and growth of amateur radio worldwide; advocates for meaningful access to radio spectrum; strives for every member to get involved, get active, and get on the air; encourages radio experimentation and, through its members, advances radio technology and education; and organizes and trains volunteers to serve their communities by providing public service and emergency communications (*ARRL's Vision Statement, adopted in January 2016*).

ARRL is an incorporated, noncommercial association without capital stock chartered under the laws of the State of Connecticut, and is an exempt organization under Section 501(c)(3) of the Internal Revenue Code of 1986. Its affairs are governed by a Board of Directors, whose voting members are elected every 3 years by the general membership. The officers are elected or appointed by the Directors.

ARRL is noncommercial, and no one with a pervasive and continuing conflict of interest is eligible for membership on its Board.

"Of, by, and for the radio amateur," ARRL numbers within its ranks the vast majority of active amateurs in the nation and has a proud history of achievement as the standard-bearer in amateur affairs.

A *bona fide* interest in amateur radio is the only essential qualification of membership; an amateur radio license is not a prerequisite, although full voting membership is granted only to licensed amateurs in the US.

Membership inquiries and general correspondence should be addressed to the administrative headquarters: ARRL, 225 Main St., Newington, Connecticut 06111-1400 USA.



## Officers, Division Directors, and Staff

As an ARRL member, you elect the Director and Vice Director who represent your Division on ARRL policy matters. If you have a question or comment about ARRL policies, contact your representatives listed below.

### Officers

**Founding President (1914-1936)**  
Hiram Percy Maxim, W1AW

**President**  
Rick Roderick, K5UR\*  
P.O. Box 1463, Little Rock, AR 72203  
(501-988-2527); [k5ur@arrl.org](mailto:k5ur@arrl.org)

**First Vice President**  
Michael N. Raisbeck, K1TWF\*  
85 High Street  
Chelmsford, MA 01824  
(978-250-1236); [k1twf@arrl.org](mailto:k1twf@arrl.org)

**Second Vice President**  
Bob Vallio, W6RGG  
18655 Sheffield Rd.  
Castro Valley, CA 94546  
(510-537-8704); [w6rgg@arrl.org](mailto:w6rgg@arrl.org)

**International Affairs Vice President**  
Rodney J. Stafford, W6ROD  
5155 Shadow Est.  
San Jose, CA 95135  
(408-238-4671); [w6rod@arrl.org](mailto:w6rod@arrl.org)

**Interim Chief Executive Officer and Secretary\***  
Barry J. Shelley, N1VXY  
225 Main St.  
Newington, CT 06111  
[bjshelley@arrl.org](mailto:bjshelley@arrl.org)

**Treasurer**  
Rick Niswander, K7GM

**Chief Financial Officer**  
Diane Middleton, W2DLM

### Staff

**Communications Manager**  
David Isgur, N1RSN

**Development Manager**  
Melissa Stemmer, KC1MHM

**Director of Operations**  
Norm Fusaro, W3IZ

**Laboratory Manager**  
Ed Hare, W1RFI

**Assistant Laboratory Manager**  
Bob Allison, WB1GCM

**Product Development Manager**  
Bob Inderbitzen, NQ1R

**Marketing Communications Manager**  
Kathleen Callahan, KC1MBY

**Marketing & Sales Manager**  
Yvette Vinci, KC1AIM

**Membership Manager**  
Diane Petrilli, KB1RNF

**Production & Editorial Manager**  
Steve Ford, WB8IMY

**Advertising Sales Manager**  
Janet Rocco, W1JLR

**Assistant Secretary/  
Regulatory Information Manager**  
Dan Henderson, N1ND

**VEC Manager**  
Maria Somma, AB1FM

**Lifelong Learning Manager**  
Kris Bickell, K1BIC

**Radiosport & Field Services Manager**  
Bart Jahnke, W9JJ

### Business Staff

**Controller**  
Thomas Bell, KC1MHQ

**Information Technology Manager**  
Michael Keane, K1MK

\*Executive Committee Member

### Atlantic Division

[www.atldiv.org](http://www.atldiv.org)  
**Tom Abernethy, W3TOM\***  
P.O. Box 73, Accokeek, MD 20607  
(301-257-6225); [w3tom@arrl.org](mailto:w3tom@arrl.org)

*Vice Director: Robert B. Famiglio, K3RF*  
P.O. Box 9, Media, PA 19063  
(610-359-7300); [k3rf@arrl.org](mailto:k3rf@arrl.org)

### Central Division

[www.central.arrl.org](http://www.central.arrl.org)  
**Kermit Carlson, W9XA\***  
1150 McKee St., Batavia, IL 60510  
(630-879-0983); [w9xa@arrl.org](mailto:w9xa@arrl.org)

*Vice Director: Carl Luetzelschwab, K9LA*  
1227 Pion Rd., Fort Wayne, IN 46845  
(260-637-6988); [k9la@arrl.org](mailto:k9la@arrl.org)

### Dakota Division

[www.arlldakota.org](http://www.arlldakota.org)  
**Matt Holden, K0BBC**  
400 Marquette Ave., Apt. 3006  
Minneapolis, MN 55401  
(952-232-1984); [k0bbc@arrl.org](mailto:k0bbc@arrl.org)

*Vice Director: Lynn Nelson, W0ND*  
3204 Willow Ln. SE, Minot, ND 58701  
(701-833-1000); [w0nd@arrl.org](mailto:w0nd@arrl.org)

### Delta Division

[arrldelta.org](http://arrldelta.org)  
**David A. Norris, K5UZ**  
907 Evening Sunset Cir., Redfield, AR 72132  
(870-613-1606); [k5uz@arrl.org](mailto:k5uz@arrl.org)

*Vice Director: Ed B. Hudgens, WB4RHQ*  
1441 Wexford Downs Ln., Nashville, TN 37211  
(615-333-9859); [wb4rhq@arrl.org](mailto:wb4rhq@arrl.org)

### Great Lakes Division

[arrl-greatlakes.org](http://arrl-greatlakes.org)  
**Dale Williams, WA8EFK\***  
291 Outer Dr., Dundee, MI 48131  
(734-529-3232); [wa8efk@arrl.org](mailto:wa8efk@arrl.org)

*Vice Director: Thomas Delaney, W8WTD*  
4632 Glenway Ave., Cincinnati, OH 45238  
(513-921-7423); [w8wtd@arrl.org](mailto:w8wtd@arrl.org)

### Hudson Division

[www.hudson.arrl.org](http://www.hudson.arrl.org)  
**Ria Jairam, N2RJ**  
P.O. Box 73, Sussex, NJ 07461  
(973-594-6275); [n2rj@arrl.org](mailto:n2rj@arrl.org)

*Vice Director: William Hudzik, W2UDT*  
111 Preston Dr., Gillette, NJ 07933  
(908-580-0493); [w2udt@arrl.org](mailto:w2udt@arrl.org)

### Midwest Division

[www.arlmidwest.org](http://www.arlmidwest.org)  
**Rod Blocksom, K0DAS**  
690 Eastview Dr., Robins, IA 52328-9768  
(319-393-8022); [k0das@arrl.org](mailto:k0das@arrl.org)

*Vice Director: Art Zygielbaum, K0AIZ*  
6601 Pinecrest Dr., Lincoln, NE 68516  
(402-421-0839); [k0aiz@arrl.org](mailto:k0aiz@arrl.org)

### How to Contact ARRL Staff

To send an email to any ARRL Headquarters staff member, put his or her call sign (or first initial and last name) in front of [@arrl.org](mailto:@arrl.org). For example, to send to Hiram Maxim, First President of the ARRL, use [w1aw@arrl.org](mailto:w1aw@arrl.org), or [hmaxim@arrl.org](mailto:hmaxim@arrl.org).

### New England Division

**Fred Hopengarten, K1VR\***  
6 Willarch Rd., Lincoln, MA 01773  
(781-259-0088); [k1vr@arrl.org](mailto:k1vr@arrl.org)  
*Vice Director: Vacant*

### Northwestern Division

[www.arlnwdiv.org](http://www.arlnwdiv.org)  
**Mike Ritz, W7VO**  
33643 Burma Rd., Scappoose, OR 97056  
(503-987-1269); [w7vo@arrl.org](mailto:w7vo@arrl.org)  
*Vice Director: Mark J. Tharp, KB7HDX*  
P.O. Box 2222, Yakima, WA 98907  
(509-952-5764); [kb7hdx@arrl.org](mailto:kb7hdx@arrl.org)

### Pacific Division

[pacific.arrl.org](http://pacific.arrl.org)  
**Jim Tiemstra, K6JAT**  
13450 Skyline Blvd., Oakland, CA 94619  
(510-569-6963); [k6jat@arrl.org](mailto:k6jat@arrl.org)  
*Vice Director: Kristen McIntyre, K6WX*  
900 Golden Wheel Park Dr., #85, San Jose, CA 95112 (510-703-4942); [k6wx@arrl.org](mailto:k6wx@arrl.org)

### Roanoke Division

[arrl-roanoke.com](http://arrl-roanoke.com)  
**George W. "Bud" Hippius, W2RU\***  
981 Circle Creek Rd., Penhook, VA 24137  
(540-576-2527); [w2ru@arrl.org](mailto:w2ru@arrl.org)  
*Vice Director: Bill Morine, N2COP*  
101 Windlass Dr., Wilmington, NC 28409  
(910-452-1770); [n2cop@arrl.org](mailto:n2cop@arrl.org)

### Rocky Mountain Division

[www.rockymountaindivision.org](http://www.rockymountaindivision.org)  
**Jeff Ryan, K0RM**  
9975 Wadsworth Pkwy. K2-275  
Westminster, CO 80021  
(303-432-2886); [k0rm@arrl.org](mailto:k0rm@arrl.org)  
*Vice Director: Robert Wareham, N0ESQ*  
300 Plaza Dr., Suite 200  
Highlands Ranch, CO 80129  
(720-592-0394); [n0esq@arrl.org](mailto:n0esq@arrl.org)

### Southeastern Division

[www.facebook.com/ARRLSoutheasternDivision](http://www.facebook.com/ARRLSoutheasternDivision)  
**Mickey Baker, N4MB**  
14764 Black Bear Rd., West Palm Beach, FL 33418 (954-667-3553); [n4mb@arrl.org](mailto:n4mb@arrl.org)  
*Vice Director: James Schilling, KG4JSZ*  
44 Joel Massey Rd., Haines City, FL 33844  
(407-504-2629); [kg4jsz@arrl.org](mailto:kg4jsz@arrl.org)

### Southwestern Division

[www.kkn.net/n6aa](http://www.kkn.net/n6aa)  
**Richard J. Norton, N6AA**  
21290 West Hillside Dr., Topanga, CA 90290  
(310-455-1138); [richardjnorton@yahoo.com](mailto:richardjnorton@yahoo.com)  
*Vice Director: Vacant*

### West Gulf Division

[westgulfdivision.org](http://westgulfdivision.org)  
**John Robert Stratton, N5AUS**  
P.O. Box 2232, Austin, TX 78768-2232  
(512-445-6262); [n5aus@n5aus.com](mailto:n5aus@n5aus.com)  
*Vice Director: Lee H. Cooper, W5LHC*  
2507 Autrey Dr., Leander, TX 78641  
(512-658-3910); [lcooper@arrl.org](mailto:lcooper@arrl.org)

## ARRL Section Managers

The 15 Divisions of ARRL are arranged into 71 administrative *Sections*, each headed by an elected *Section Manager* (SM). Your Section Manager is the person to contact when you have news about your activities, or those of your radio club. If you need assistance with a local problem, your Section Manager is your first point of contact. He or she can put you in touch with various ARRL volunteers who can help (such as Technical Specialists). Your Section Manager is also the person to see if you'd like to become a Section volunteer. Whatever your license class, your SM has an appointment available. Visit your Section page at [www.arrl.org/sections](http://www.arrl.org/sections).

### Atlantic Division (DE, EPA, MDC, NNY, SNJ, WNY, WPA)

**Delaware:** Bill Duveneck, KB3KYH, 18682 Sunny Sky Blvd., Milton, DE 19968-2486 (302-537-4755); [kb3kyh@arrl.org](mailto:kb3kyh@arrl.org)  
**Eastern Pennsylvania:** George Miller, W3GWM, 293 Woods Rd., Wyalusing, PA 18853 (570-250-1007); [w3gwm@arrl.org](mailto:w3gwm@arrl.org)  
**Maryland-DC:** Marty Pittinger, KB3MXM, 4 Pegrum Rd., Owings Mills, MD 21117 (410-356-7899); [kb3mxm@arrl.org](mailto:kb3mxm@arrl.org)  
**Northern New York:** Thomas Dick, KF2GC, 11 Jenkins St., Saranac Lake, NY 12983 (518-891-0509); [kf2gc@arrl.org](mailto:kf2gc@arrl.org)  
**Southern New Jersey:** Tom Preiser, N2XW, 177 Bowsprit Rd., Manahawkin, NJ, 08050-5001 (609-618-0224); [n2xw@arrl.org](mailto:n2xw@arrl.org)  
**Western New York:** Laura Mueller, N2LJM, 2011 E. Main St., Falconer, NY 14733 (716-338-3122); [n2ljm@arrl.org](mailto:n2ljm@arrl.org)  
**Western Pennsylvania:** Joe Shupienis, W3BC, P.O. Box 73, Falls Creek, PA 15840-0322 (814-771-3804); [w3bc@arrl.org](mailto:w3bc@arrl.org)

### Central Division (IL, IN, WI)

**Illinois:** Ron Morgan, AD9I, 114 Herman St., East Peoria, IL 61611-4420 (309-397-9549); [ad9i@arrl.org](mailto:ad9i@arrl.org)  
**Indiana:** James Merry, Jr., KC9RPX, 7332 W. Mustang Dr., Ellettsville, IN 47429 (812-391-2661); [kc9rpx@arrl.org](mailto:kc9rpx@arrl.org)  
**Wisconsin:** Patrick Moretti, KA1RB, W349S3970 Waterville Rd., Dousman, WI 53118-9786 (262-354-2997); [ka1rb@arrl.org](mailto:ka1rb@arrl.org)

### Dakota Division (MN, ND, SD)

**Minnesota:** Richard H. "Skip" Jackson, KS0J, 1835-63rd St. E, Inver Grove Heights, MN 55077 (651-260-4330); [ks0j@arrl.org](mailto:ks0j@arrl.org)  
**North Dakota:** Nancy Yoshida, K0YL, 1079 Harvest Ln. NE, Thompson, ND 58278-9408 (218-779-6596); [k0yl@arrl.org](mailto:k0yl@arrl.org)  
**South Dakota:** Chris Stallkamp, K10D, P.O. Box 271, Selby, SD 57472-0271 (605-870-1784); [ki0d@arrl.org](mailto:ki0d@arrl.org)

### Delta Division (AR, LA, MS, TN)

**Arkansas:** James D. Ferguson, Jr., N5LKE, 1500 Lauren Dr., Searcy, AR 72143-8477 (501-593-5695); [n5lke@arrl.org](mailto:n5lke@arrl.org)  
**Louisiana:** John Mark Robertson, K5JMR, 201 Madewood Ct., Bossier City, LA 71111-6325 (318-572-7917); [k5jmr@arrl.org](mailto:k5jmr@arrl.org)  
**Mississippi:** Malcolm Keown, W5SX, 64 Lake Cir. Dr., Vicksburg, MS 39180 (601-636-0827); [w5sx@arrl.org](mailto:w5sx@arrl.org)  
**Tennessee:** David Thomas, KM4NYI, 205 Linford Rd., Knoxville, TN 37920 (865-654-5489); [km4nyl@arrl.org](mailto:km4nyl@arrl.org)

### Great Lakes Division (KY, MI, OH)

**Kentucky:** Steve Morgan, W4NHO, 1124 W. 12th St., Owensboro, KY 42301-2975 (270-926-4451); [w4nho@arrl.org](mailto:w4nho@arrl.org)  
**Michigan:** Jim Kvochick, K8JK, 10366 Greystone Ct., Brighton, MI 48114-7650 (810-229-5085); [k8jk@arrl.org](mailto:k8jk@arrl.org)  
**Ohio:** Scott D. Yonally, N8SY, 258 Valley Hi Dr., Mansfield, OH 44904-9792 (419-512-4445); [n8sy@arrl.org](mailto:n8sy@arrl.org)

### Hudson Division (ENY, NLI, NNJ)

**Eastern New York:** John K. Fritze, Jr., K2QY, 4 Normanskill Blvd., Delmar, NY 12054-1335(401-261-4996); [k2qy@arrl.org](mailto:k2qy@arrl.org)  
**NYC-Long Island:** Jim Mezey, W2KFF, 38 Appletree Ln., Carle Place, NY 11514-1336 (516-315-8608); [w2kff@arrl.org](mailto:w2kff@arrl.org)  
**Northern New Jersey:** Steve Ostrove, K2SO, 249 Keats Ave., Elizabeth, NJ 07208-1059 (908-403-8943); [k2so@arrl.org](mailto:k2so@arrl.org)

### Midwest Division (IA, KS, MO, NE)

**Iowa:** Lelia Garner, WA0UIG, 145 Front St., Robins, IA 52328-9718 (319-213-3539); [wa0uig@arrl.org](mailto:wa0uig@arrl.org)  
**Kansas:** Ronald D. Cowan, KB0DTI, P.O. Box 36, LaCygne, KS 66040 (913-757-3758); [kb0dti@arrl.org](mailto:kb0dti@arrl.org)  
**Missouri:** Cecil Higgins, AC0HA, 27995 County Rd. 220, Hermitage, MO 65668-8493 (417-399-5027); [ac0ha@arrl.org](mailto:ac0ha@arrl.org)  
**Nebraska:** Matthew N. Anderson, KA0BOJ, 14300 NW 98th St., Raymond, NE 68428-4254 (402-480-5515); [ka0boj@arrl.org](mailto:ka0boj@arrl.org)

### New England Division (CT, EMA, ME, NH, RI, VT, WMA)

**Connecticut:** Charles I. Motes, Jr., K1DFS, 22 Woodside Ln., Plainville, CT 06062 (860-747-6377); [k1dfs@arrl.org](mailto:k1dfs@arrl.org)  
**Eastern Massachusetts:** Tom Walsh, K1TW, 9 Wildwood Dr., Bedford, MA 01730 (781-275-5882); [k1tw@arrl.org](mailto:k1tw@arrl.org)  
**Maine:** Bill Crowley, K1NIT, 150 Maple St., Farmingdale, ME 04344-4809 (207-512-0312); [k1nit@arrl.org](mailto:k1nit@arrl.org)  
**New Hampshire:** John Gotthardt, K1UAF, P.O. Box 2298, Wolfeboro, NH 03894-2298 (603-569-3633); [k1uaf@arrl.org](mailto:k1uaf@arrl.org)  
**Rhode Island:** Bob Beaudet, W1YRC, 30 Rocky Crest Rd., Cumberland, RI 02864 (401-333-2129); [w1yrc@arrl.org](mailto:w1yrc@arrl.org)  
**Vermont:** Paul N. Gayet, AA1SU, 11 Cherry St., Essex Junction, VT 05452 (802-878-2215); [aa1su@arrl.org](mailto:aa1su@arrl.org)  
**Western Massachusetts:** Raymond Lajoie, KB1LRL, 245 Leominster Rd., Lunenburg, MA 01462-2031 (978-549-5507); [kb1lrl@arrl.org](mailto:kb1lrl@arrl.org)

### Northwestern Division (AK, EWA, ID, MT, OR, WWA)

**Alaska:** David Stevens, KL7EB, 8521 Golden St., Apt. 4, Anchorage, AK 99502 (907-242-6483); [kl7eb@arrl.org](mailto:kl7eb@arrl.org)  
**Eastern Washington:** Jack Tiley, AD7FO, 1806 S. Fawn Dr., Spokane Valley, WA 99206-3318 (509-951-7214); [ad7fo@arrl.org](mailto:ad7fo@arrl.org)  
**Idaho:** Dan Marler, K7REX, 6525 W. Fairfield Ave., Boise, ID 83709 (208-914-8939); [k7rex@arrl.org](mailto:k7rex@arrl.org)  
**Montana:** Paul Stiles, KF7SOJ, 5427 Deadwood Dr., Billings, MT 59105 (406-671-7092); [kf7soj@arrl.org](mailto:kf7soj@arrl.org)  
**Oregon:** David Kidd, KA7OZO, 21760 S. Larkspur Ave., Oregon City, OR 97045-9164 (503-320-3484); [ka7ozo@arrl.org](mailto:ka7ozo@arrl.org)  
**Western Washington:** Monte L. Simpson, W7FF, P.O. Box 3008, Silverdale, WA 98383 (360-633-7665); [w7ff@arrl.org](mailto:w7ff@arrl.org)

### Pacific Division (EB, NV, PAC, SV, SF, SJV, SCV)

**East Bay:** Jim Siemons, W6LK, 2308 Lomond Ln., Walnut Creek, CA 94598-3705 (925-330-0049); [w6lk@arrl.org](mailto:w6lk@arrl.org)  
**Nevada:** John Bigley, N7UR, 2420 Palora Ave., Las Vegas, NV 89121-2157 (702-673-0904); [n7ur@arrl.org](mailto:n7ur@arrl.org)  
**Pacific:** Joe Spononi, AH0A, 278 Kapiolani Blvd. #502, Honolulu, HI 96826 (808-955-2496); [ah0a@arrl.org](mailto:ah0a@arrl.org)  
**Sacramento Valley:** Dr. Carol Milazzo, KP4MD, P.O. Box 665, Citrus Heights, CA 95611-0665 (916-879-7449); [kp4md@arrl.org](mailto:kp4md@arrl.org)  
**San Francisco:** Bill Hillendahl, KH6JV, P.O. Box 4151, Santa Rosa, CA 95402-4151 (707-544-4944); [kh6jv@arrl.org](mailto:kh6jv@arrl.org)  
**San Joaquin Valley:** John Litz, NZ6Q, 1434 Douglas Rd., Stockton, CA 95207-3536 (209-331-3078); [nz6q@arrl.org](mailto:nz6q@arrl.org)  
**Santa Clara Valley:** Brandon Bianchi, NI6C, P.O. Box 60128, Palo Alto, CA 94306 (559-313-3373); [ni6c@arrl.org](mailto:ni6c@arrl.org)

### Raanoke Division (NC, SC, VA, WV)

**North Carolina:** Karl Bowman, W4CHX, 5509 Shimer Farm Ln., Raleigh, NC 27614-6301 (919-669-6068); [w4chx@arrl.org](mailto:w4chx@arrl.org)  
**South Carolina:** Marc Tarplee, N4UFP, 4406 Deer Run, Rock Hill, SC 29732-9258 (803-327-4978); [n4ufp@arrl.org](mailto:n4ufp@arrl.org)  
**Virginia:** Joseph Palsa, K3WRY, 9101 Arch Hill Ct., Richmond, VA 23236-2725 (804-350-2665); [k3wry@arrl.org](mailto:k3wry@arrl.org)  
**West Virginia:** Dan Ringer, K8WV, 18 W. Front St., Morgantown, WV 26501-4507 (304-292-1999); [k8wv@arrl.org](mailto:k8wv@arrl.org)

### Rocky Mountain Division (CO, NM, UT, WY)

**Colorado:** Jack Ciaccia, WM0G, P.O. Box 21362, Boulder, CO 80308-4362 (303-587-0993); [wm0g@arrl.org](mailto:wm0g@arrl.org)  
**New Mexico:** Bill Mader, K8TE, 4701 Somberele Rd. SE, Rio Ranchó, NM 87124 (505-250-8570); [k8te@arrl.org](mailto:k8te@arrl.org)  
**Utah:** Mel Parkes, NM7P, 2166 E. 2100 North, Layton, UT 84040 (801-547-1753); [nm7p@arrl.org](mailto:nm7p@arrl.org)  
**Wyoming:** Rick Breininger, N1TEK, 11 E. 2nd North St., Green River, WY 82935 (307-707-4010); [n1tek@arrl.org](mailto:n1tek@arrl.org)

### Southeastern Division (AL, GA, NFL, PR, SFL, VI, WCF)

**Alabama:** J'Vann Martin, W4JVM, 16 Baron Dr., Chelsea, AL 35043-6607 (205-281-4728); [w4jvm@arrl.org](mailto:w4jvm@arrl.org)  
**Georgia:** David Benoist, AG4ZR, 190 Fox Hall Crossing East, Senoia, GA 30276 (404-290-0470); [ag4zr@arrl.org](mailto:ag4zr@arrl.org)  
**Northern Florida:** Kevin J. Bess, KK4BFN, 908 Flagler Ave., Edgewater, FL 32132-2124 (386-547-2838); [kk4bfn@arrl.org](mailto:kk4bfn@arrl.org)  
**Puerto Rico:** Oscar Resto, KP4RF, HC 77 Box 8743, Vega Alta, PR 00692-9660 (787-883-6878); [kp4rf@arrl.org](mailto:kp4rf@arrl.org)  
**Southern Florida:** Barry M. Porter, KB1PA, 14555 Sims Rd., Apt. 251, Delray Beach, FL 33484 (561-499-8424); [kb1pa@arrl.org](mailto:kb1pa@arrl.org)  
**Virgin Islands:** Fred Kleber, K9VV, P.O. Box 24275, Christiansted, VI 00824-0275 [k9vv@arrl.org](mailto:k9vv@arrl.org)  
**West Central Florida:** Darrell Davis, KT4WX, 6350 Mills Rd., Fort Meade, FL 33841 (863-245-9923); [kt4wx@arrl.org](mailto:kt4wx@arrl.org)

### Southwestern Division (AZ, LAX, ORG, SDG, SB)

**Arizona:** Rick Paquette, W7RAP, 1600 W. Sunkist Rd., Tucson, AZ 85755-9561 (520-425-6877); [w7rap@arrl.org](mailto:w7rap@arrl.org)  
**Los Angeles:** Diana Feinberg, A6DF, P.O. Box 4678, Palos Verdes Peninsula, CA 90274-9618 (310-544-2917); [a6df@arrl.org](mailto:a6df@arrl.org)  
**Orange:** Carl Gardenias, WU6D, 20902 Gardenias St., Perris, CA 92570 (951-490-2270); [wu6d@arrl.org](mailto:wu6d@arrl.org)  
**San Diego:** Dave Kaltenborn, N8KBC, 630 Alber St., Chula Vista, CA 91911 (619-616-8758); [n8kbc@arrl.org](mailto:n8kbc@arrl.org)  
**Santa Barbara:** John Kitchens, NS6X, P.O. Box 178, Somis, CA 93066 (805-216-2569); [ns6x@arrl.org](mailto:ns6x@arrl.org)

### West Gulf Division (NTX, OK, STX, WTX)

**North Texas:** Steven Lott Smith, KG5VK, 125 Contest Ln., Ben Franklin, TX 75415-3830 (318-470-9806); [kg5vk@arrl.org](mailto:kg5vk@arrl.org)  
**Oklahoma:** Kevin O'Dell, N0IRW, 1718 South Fairgrounds, Stillwater, OK 74074 (580-220-9062); [n0irw@arrl.org](mailto:n0irw@arrl.org)  
**South Texas:** Paul Gilbert, KE5ZW, 1209 Doris Ln., Cedar Park, TX 78613-7067 (512-940-0441); [ke5zw@arrl.org](mailto:ke5zw@arrl.org)  
**West Texas:** H. Dale Durham, W5WI, P.O. Box 375, Buffalo Gap, TX 79508 (830-719-9000); [w5wi@arrl.org](mailto:w5wi@arrl.org)

**Ameritron...The World's High Power Leader!**

# AMERITRON...800 Watts... \$1109!

More hams use Ameritron AL-811H amplifiers than any other amplifier in the world!



Only the Ameritron AL-811H gives you four fully neutralized 811A transmitting tubes.

**AL-811H**  
**\$1199**  
Suggested Retail  
4-Tubes, 800 Watts

You get absolute stability and superb performance on higher bands that can't be matched by un-neutralized tubes.

**AL-811**  
**\$1099**  
Suggested Retail  
3-Tubes, 600 Watts

You get a quiet desktop linear that's so compact it'll slide right into your operating position - you'll hardly know it's there... until QRM sets in. And you can conveniently plug it into your nearest

120 VAC outlet - no special wiring needed.

You get all HF band coverage (with license) - including WARC and most MARS bands at 100% rated output. Ameritron's *Adapt-A-Volt™* hi-silicon core power transformer has a special buck-boost winding that lets you compensate for high/low power line voltages.

You also get efficient full size heavy duty tank coils, slug tuned input coils, operate/standby switch, transmit LED, ALC, dual illuminated meters, QSK with optional QSK-5, pressurized cooling that you can hardly hear, full height computer grade filter capacitors and more. 13<sup>3</sup>/<sub>4</sub>"W x 8" H x 16" D inches.

**AL-811, \$1099.** Like AL-811H, but has three 811A tubes and 600 Watts output.

## AMERITRON no tune Solid State Amplifiers

**ALS-500M 500 Watt Mobile Amp**



**ALS-500M**  
**\$999**  
Suggested Retail

500 Watts PEP/400W CW output, 1.5-22 MHz, instant bandswitching, no tuning, no warm-up, SWR, load fault, thermal overload protected. On/Off/Bypass switch. Remote on/off control. DC current meter. Extremely quiet fan. 13.8 VDC. 9W x 3<sup>1</sup>/<sub>2</sub>"H x 15" D in., 7 lbs. **ALS-500RC, \$64.95** Remote Head.

**ALS-606S 600 Watt 160-6M Amp**

600 Watts PEP/500W CW output, 160-6 Meters with automatic instant bandswitching from your transceiver. Fits on your desktop. 9<sup>3</sup>/<sub>4</sub>"W x 7" H x 14<sup>1</sup>/<sub>2</sub>" D in. and weighs 14.2 lbs., but is only 4 dB below 1500 Watts -- less than an S-unit!



**ALS-606S**  
**\$2099**  
Suggested Retail

**ALS-606, \$2299**, like ALS-606S but has transformer power supply. **New Lower price!** **ALS-600S, \$1899** with switching power supply. **ALS-600, \$1999** with transformer power supply.

**ALS-1306 1200W 1.5-5.4 MHz Amp**



**ALS-1306**  
**\$3499**  
Suggested Retail

automatic bandswitching! Get 1200W PEP output on all bands, including 6-Meters. No tuning, no warm-up, no tubes to baby and no fuss! Eight rugged MRF-150 power FET's give outstanding reliability. Just 100 Watts drive gives full rated power MHz. Compact 10W x 6<sup>1</sup>/<sub>2</sub>"H x 18" D in., just 22 lbs. **ALS-1300, \$3099.** Like ALS-1306 but less automatic bandswitching and 6-M coverage.

Ameritron's highest power solid state FET amplifier gives you

## AMERITRON full legal limit amplifiers

AMERITRON legal limit amps use a super heavy duty Peter Dahl Hypersil® power transformer capable of 2.5 kW!

Most powerful - 3CX1500/8877



**AL-1500F**  
**\$3999**

3CX1500/8877 Tube  
Suggested Retail

**AL-1500**  
**\$4999**

Eimac® Tube  
Suggested Retail

Ameritron's most powerful amplifier uses the herculean 3CX1500/8877 ceramic tube. 65 watts drive gives you full legal output - it's just loafing with a 2500 Watts power supply.

Toughest - 3CX1200/Z7



**AL-1200**  
**\$4899**  
Suggested Retail

Get ham radio's toughest tube with the Ameritron

AL-1200 - the Eimac® 3CX1200Z7. It has a 50 Watt control grid dissipation. What makes the Ameritron AL-1200 stand out from other legal limit amplifiers? The answer: a super heavy duty power supply that loafs at full legal power - it can deliver the power of more than 2500 Watts PEP two tone output for a half hour.

Classic - Dual 3-500Gs



**AL-82**  
**\$3499**  
Suggested Retail

This linear gives you full legal output using a pair of genuine 3-500Gs. Competing linears using 3-500Gs can't give you 1500 Watts because their lightweight power supplies can't use these tubes to their full potential.

Call your favorite dealer for your best price today!

### Desktop Kilowatt Amplifier



**AL-80B**  
**\$1899**  
Suggested Retail

Whisper quiet desktop amp plugs into 120 VAC to

give full kilowatt SSB PEP output. Ameritron's exclusive DynamicALC™ doubles average SSB power out and Instantaneous RF Bias™ gives cooler operation. All HF bands. 850 Watts CW out, 500 Watts RTTY out, extra heavy duty power supply, 3-500G tube, 70% efficiency, tuned input, Pi/Pi-L output, inrush current protection, dual Cross-Needle meters, QSK compatible, 48 lbs. 14W x 8<sup>1</sup>/<sub>2</sub>"H x 15<sup>1</sup>/<sub>2</sub>" D in. **Two-year warranty.**

### Near Legal Limit™ Amplifier



**AL-572**  
**\$2099**  
Suggested Retail

New class of Near Legal Limit™ amplifier gives you 1300 Watt PEP SSB power output for 60% of price of a full legal limit amp! 4 rugged 572B tubes. Instant 3-second warmup, plugs into 120 VAC. Compact 14<sup>1</sup>/<sub>2</sub>"W x 8<sup>1</sup>/<sub>2</sub>"H x 15<sup>1</sup>/<sub>2</sub>" D inches fits on desktop. 160-15 Meters. 1000 Watt CW output. Tuned input, instantaneous RF Bias, dynamic ALC, parasitic killer, inrush protection, two lighted cross-needle meters, multi-voltage transformer.

### HF Amps with 3CX800A7 Tube



Suggested Retail  
**AL-800**  
**\$2999**  
1 tube, 1250 W

**AL-800H**  
**\$4299**  
2 tubes, 1.5 kW Plus with Eimac® tubes

These compact desktop amplifiers with 3CX800A7 tubes cover 160-15 Meters including WARC bands.

Adjustable slug tuned input circuit, grid protection, front panel ALC control, vernier reduction drives, heavy duty 32 lb. silicone steel core transformer, high capacitance computer grade filter capacitors. Multivoltage operation, dual lighted cross-needle meters. 14<sup>1</sup>/<sub>4</sub>"W x 8<sup>1</sup>/<sub>2</sub>"H x 16<sup>1</sup>/<sub>2</sub>" D in.

### Ameritron brings you the finest high power accessories!

**ARB-704 amp-to-rig interface...\$74<sup>95</sup>**  
Protects rig from damage by keying line transients and makes hook-up to your rig easy!

**ADL-1500 Dummy Load with oil...\$89<sup>95</sup>**  
Oil-cooled. 50 Ohms. 1500 Watts/5 minutes. SWR< 1.2 to 30 MHz. Low SWR to 400 MHz.

**RCS-8V Remote Coax Switch...\$229<sup>95</sup>**  
Replace 5 coax with 1! 1.2 SWR at 250 MHz. Useable to 450 MHz. < .1 dB loss, 1kW@ 150MHz.

**RCS-10 Remote Coax Switch...\$229<sup>95</sup>**  
Replace 8 coax SWR<1.3 to 60 MHz.  
**RCS-10L, \$269.95** w/lightning arrestors.



The World's High Power Leader 116 Willow Rd, Starkville, MS 39759

■ Tech: (662) 323-8211 ■ FAX: (662) 323-6551 8 a.m.-4:30 p.m. CST, Monday-Friday

# FULL Digital Mode Support is just **ONE CALL** away!



Call **208-635-5490** today or  
email [support@westmountainradio.com](mailto:support@westmountainradio.com)  
for a friendly & fast solution to your RIGblaster Questions!

- **Full Support**

Pre-purchases, buying and owners get full support!

- **Setup & Configuration**

Our experts will guide you to the right hardware and take time to help you with software configuration

- **Expert Advice**

Let us remove the confusion of using modern digital modes like FT8 with Windows 10, Linux or Mac OS!

Whether you're looking for a cost-effective Nomic or a fully-featured Advantage, West Mountain Radio has you covered!



RIGblaster Nomic

Cables included fit most radios!  
Low-cost entry into digital modes!  
Perfect for Echolink!  
Unbeatable price!



RIGblaster Advantage

Cables included fit most radios!  
High performance sound card!  
CAT Control!  
Real CW & FSK Keying  
External controls for easy adjustment!

Sales: 262-522-6500 Ext 35  
[sales@westmountainradio.com](mailto:sales@westmountainradio.com)

[westmountainradio.com/QST320](http://westmountainradio.com/QST320)



# KX Line: KX3/KX2 Elecraft® Full-Featured Ultra-portables 100W with Matching Amp

**ELECRAFT  
KX3**

**SSB/CW/Data/AM/FM • 160-6 m • 15 W**



**NEW!**  
KX Line Packages  
Visit [Elecraft.com](http://Elecraft.com)  
for details

**ELECRAFT  
KX2**

**SSB/CW/Data/AM/FM • 80-10 m • 12 W**



**NEW!**  
AX1 20/17 Whip  
Antenna for the  
KX2!  
Call for details

**The KX3** has become the compact, 160-6 meter, all-mode transceiver of choice for thousands of hams, for home, travel, and portable use. Its versatility has been demonstrated at countless Field Day and DXpedition operations.

- Matching PX3 panadapter with fast, full-color spectrum/waterfall\*
- 7.4" x 3.5" x 1.7" (weight: 1.5 lbs.)
- Best-in-class performance
- 160-6 meters plus 2 or 4 m\*
- SSB, CW, AM, FM, Data
- Up to 15 W TX
- Weighted, free-spinning VFO knob
- Precision roofing filter\*
- Wide-range internal ATU\*

**Our KX2** "stealth" transceiver can go wherever your imagination takes you. It's pocket sized, yet it transmits at up to 12 watts, covers 9 bands, and shares many features with the KX3. It also works with the KXPA100 amp.

- 5.8" x 2.8" x 1.5" (weight: 13 oz.)
- Ultralight grab-and-go station, perfect for SOTA and field operation
- 80-10 meters (9 bands)
- SSB / CW / Data / AM / FM
- Up to 12 W TX
- Internal 2.6 Ah Li-ion battery\*
- Built-in mic for HT-style operation
- Wide-range internal ATU\*
- New KXPD2 compact keyer paddle\*

\* Option

## Make Waves in Style with the New K-Line. K4 Direct-Sampling SDR and KPA 1500 Legal-Limit Amp



### K4 Features

Direct sampling SDR • Modular, hybrid architecture • Single or dual panadapter • High resolution tuning aid • Comprehensive I/O • Full remote control via Ethernet • 7" color screen with touch and mouse control • ATU with 10:1+ range • 3 antenna jacks • Up to 5 receive antenna sources



### KPA1500 Features

1500 W • Very compact design • Fast, silent PIN diode T/R switching • Built-in ATU with dual antenna jacks • Compatible with nearly any transceiver – custom cables available • 160-6 meters • CE for Europe

**ELECRAFT®**  
[elecraft.com](http://elecraft.com) • 831-763-4211



# Up Front

## On The Air from a Lofty Perch

Tim Carter, W3ATB, grabbed this photo of Jim Cluett, W1PID, operating from just below the summit of Cannon Mountain in New Hampshire. For Tim, the pun was irresistible: "I guess you'd say Jim had a *leg up* on all the other operators from this elevation."



## Summer School

Zach Kline, KD9LDT (shown on the mic), conducted four Radio Merit Badge classes at the Loud Thunder Scout Reservation summer camp in Illinois City, Illinois last summer during a 5-week period from June 14 to July 12. Zach, who is an Eagle Scout and holds an Amateur Extra-class license, helped approximately 65 Scouts complete and receive their Radio Merit Badges at the camp. Each Friday, he set up a portable HF station under a tent, with members of the River Bend Wireless Operators Club providing additional training in Morse code and foxhunting.



## A Proud Moment

Prospective hams Mari Ann Stevenson and her daughter Solana Stevenson operated the Williamsburg Area Amateur Radio Club's "Get On The Air" station during ARRL Field Day 2019, under the tutelage of club vice president Chuck White, AI4WU (left), as their proud father and grandfather Randy Altona, KM4YSN (right), looked on. Mari Ann and Solana passed their Technician exams last fall, earning the call signs KN4ZMH and KN4ZMG respectively, and Randy upgraded to a General-class license at the same time. [George Ewart, WG4F, photo]



## The Graduates Wore Camo



US Marines with the 2nd Radio Battalion of the II Marine Expeditionary Force Information Group; a British Royal Marine Commando with the Marine Corps Foreign Personnel Exchange Program, and civilians with the Brightleaf Amateur Radio Club in Greenville, North Carolina posed for a photo at the conclusion of an amateur radio licensing course at Camp Lejeune in Jacksonville, North Carolina last October. The objective of the course was to increase the Marines' knowledge of amateur radio in particular, and radio operating procedures in general. The club taught 20 students and finished with 19 new Technician licensees and two upgrades to General. The classes are part of a cooperative effort between the club and the Marine Corps. [Corporal Livingston, photo]

# ALINCO®

Quality. Style. Performance!



ALINCO.com



440MHz FM MOBILE TRANSCEIVER  
**DR-435TMkIII**

220MHz FM MOBILE TRANSCEIVER  
**DR-235TMkIII**

144MHz FM MOBILE TRANSCEIVER  
**DR-135TMkIII**

50MHz FM MOBILE TRANSCEIVER  
**DR-06T**

29MHz FM MOBILE TRANSCEIVER  
**DR-03T**



144 / 430MHz FM DUAL BAND HANDHELD TRANSCEIVER  
**DJ-500T/DJ-VX50HT**



\* With optional EDS-17 separate cable.

HF 100W SSB/CW/FM/AM  
DESK-TOP TRANSCEIVER  
**DX-SR8T**



SSB/AM/FM/CW and I/Q  
LW/MW/SW 150kHz to 30MHz  
DESK-TOP RECEIVER  
**DX-R8T**

With a wide selection of easy-to-operate, multi-band desktop, handheld and mobile radios, Alinco delivers maximum value for your amateur radio enjoyment.



VHF/UHF DUAL BAND, DUAL MODE  
DMR TRANSCEIVER

**DJ-MD5T/TGP**

Part 90 certified LAND MOBILE



144/440MHz  
FM FULL-DUPLEX MOBILE TRANSCEIVER  
**DR-735T**



30A SWITCHING POWER SUPPLY  
**DM-430T**



30A SWITCHING POWER SUPPLY  
**DM-330MVT**



30A SWITCHING POWER SUPPLY  
**DM-30TR**



144/440/1200MHz  
FM FULL-DUPLEX  
HANDHELD TRANSCEIVER  
**DJ-G7T**

222/902 MHz FM  
FULL-DUPLEX  
HANDHELD TRANSCEIVER  
**DJ-G29T**

REMTronix, Inc.

17508 Murphy Parkway, Lathrop, CA 95330

Ph: (209) 900-1296 Fax: (209) 624-3153 Website: <http://www.remtronix.com>

Email: [alinco@remtronix.com](mailto:alinco@remtronix.com) Service: [alinco-support@remtronix.com](mailto:alinco-support@remtronix.com)

Distributed in  
North America by

**REMTRONIX**

Products intended for properly licensed operators. Required products are FCC part 15/IC certified. Specification subject to change without notice or obligation. ALL warranty claims and requests for repair/technical assistance for Alinco products should be sent to REMTronix regardless of contact information found on the warranty certificate packed with the product.



*Ham Radio Saves Lives!*

# Turn-Key Public Service Repeater Systems 2m, 1.25m, 70cm

"If you need *EmComm*,  
you need *BridgeComm!*"

-T.H. Merritt, KL5YJ

Brewton, AL

Visit the link or call the  
number below to learn more!

**BridgeComm**  
SYSTEMS  
816-532-8451  
sales@bridgecomsystems.com

TO LEARN MORE VISIT:  
[www.bridgecomsystems.com/578](http://www.bridgecomsystems.com/578)



# Good Times Await

## BridgeCom Makes DMR Easy



### DMR Plug N' Play Package

Programmed with the most popular talk groups on Brandmeister and your state-wide talk group.

Visit the link or call the number below to learn more!



**AnyTone AT-D878UV PLUS**  <sup>®</sup>  
(Bluetooth module included)



**Bluetooth Push-to-talk Button**



**DVMEGA Hotspot**

**BridgeCom**  
SYSTEMS  
816-532-8451  
sales@bridgecomsystems.com

TO LEARN MORE VISIT:  
[www.bridgecomsystems.com/578](http://www.bridgecomsystems.com/578)

## Correspondence

# Letters from Our Members

### ARRL on Classic TV

While watching old TV shows on YouTube, I came across the 1950s show *Highway Patrol*, which is about the action-packed adventures of fictional highway police. In the episode, "Radio Active," ARRL is not only mentioned, but plays a part in the rescue. There are also some nice scenes of a '50s-era shack and the "new" boatanchors adorning it. Watch the episode on YouTube at <https://youtu.be/mMLpy8I87bY>.

**Dave Berman, WA2PAY**  
St. Augustine, Florida

### Embracing Change

I've been thinking about amateur radio and our hope that the hobby will continue to grow in the future. How amateur radio embraces change will determine our survival.

The most important thing that any ham can have, whether they have years of experience or are just starting out, is the willingness to look at new ideas and ways of doing things with an open mind. The concept of "That's how we've always done it" will be our death. As hams, we must be willing to embrace the younger generation and open our hobby to the makers of the world. Today, we have new concepts like digital modes using computers instead of microphones or keys. The building is often in software instead of soldering irons.

The ability to adapt and accept change is one of the basic principles of evolution. If we as hams do not look forward to new technology and embrace change brought by the

next generation, we are doomed to extinction. I don't mean to say we need to give up all our traditions, but we must be willing to teach the next generation so they can take those traditions to the next level.

Be a mentor, not one of the people saying, "That's not ham radio."

**Mike Walters, W8ZY**  
New Milford, Connecticut

### Touring W1AW

In the summer of 1973 (when my call was WA9PGF), I visited W1AW at ARRL Headquarters to take a tour. The W1AW team set up one of their radios with the rhombic antenna pointed due west. (The rhombic has since been taken down.) You can imagine my friend Ron's, W9MAF, surprise when he called my mobile rig and got W1AW booming in at S9 + 10 dB.

I am now retired and living in Michigan, but Ron agreed to repeat at least some of that adventure we had. In late 2019, during a week exploring the fall colors in New Hampshire, I again visited ARRL Headquarters and was treated to a great tour of W1AW thanks to my hosts — Dan Arnold, W1CNI; Steve Ewald, WV1X, and Liz Karpiej, KA1DTU.

Ron and I did make contact that morning and relived one of the more memorable radio contacts I have had the pleasure of making since becoming a ham in 1963. I hope that any amateur radio operator takes the opportunity to tour ARRL Headquarters and become more

aware of all that ARRL membership holds. Ham radio has helped me make new friends, maintain contact with those who have moved miles away, and to participate in many facets of this fascinating hobby.

**Don Hruby, K9DH**  
Ada, Michigan

### Remembering Professor Regier, OD5CG

I was extremely moved when I read "100, 50, 25" in the December 2019 issue and saw the excerpt about Frank Regier, OD5CG (SK).

Professor Regier was the chairman of the Electrical and Computer Engineering Department, Faculty of Engineering and Architecture at the American University of Beirut in Lebanon. I was a student of his from 1981 to 1982. While reading about his "trapless triband vertical antenna" mentioned in the magazine, I fondly remembered being in a group of students constructing a helical antenna for microwave frequencies that he designed and supervised. We installed it on the rooftop of the Faculty of Engineering and Architecture building and were able to conduct two-way communication using his call sign as a control operator.

I am very thankful to you to have mentioned him. All his students, with no exception, have very fond memories of a dedicated, clear-minded, and top-class engineer and educator.

**Dr. Ghassan Chammas, OD5YA**  
Beirut, Lebanon

Send your letters to "Correspondence," ARRL, 225 Main St., Newington, CT 06111. You can also submit letters by fax at 860-594-0259, or via email to [letters@arrl.org](mailto:letters@arrl.org). We read every letter received, but we can only publish a few each month. We reserve the right to edit your letter for clarity, and to fit the available page space. Letters published in "Correspondence" may also appear in other ARRL media. The publishers of *QST* assume no responsibility for statements made by correspondents.

## More Than a Radio... an Experience!



FLEX-6400



FLEX-6400M



FLEX-6600



FLEX-6600M



FLEX-6700

- All mode, 100W, 160 – 6M
- Direct Sampling SDR
- SmartLink: Plug and Play Remote
- Built in Station Integration
- 2 – 8 Full Performance Receivers

- Up to 8 FT8/digital sessions at once
- multiFLEX – 2 operators, 1 radio
- Transverter port(s): VHF/UHF/Microwave
- Two year warranty
- Manufactured in Austin, TX, USA

Starting at \$1999

# Start Planning Your Tower/Antenna Project with DX Engineering!



DXE-TB-400



DXE-AS25G



DXE-MASTLOCK

## DX ENGINEERING

### Tower Accessories

Upgrade your towers with DX Engineering designed and manufactured accessories. These include Advanced Design Thrust Bearings (for 2" and 3" O.D. masts); Tower Accessory Shelves; the Mastlock Tower Accessory, which locks your tower mast in position for worry-free antenna maintenance; and stainless steel Genius Clamps for mounting round tubing and pipe members perpendicular or parallel to each other. We also carry guy and antenna support rope, tail kits, mast kits, hardware and more. **Enter "Tower Accessories" at DXEngineering.com for complete details.**



DXE-SSGC-2P



TBX Tower



American Tower Company  
Division of Wheelabrator Technologies



### Towers

Make DX Engineering your go-to source for proven antenna towers. Choose from Rohn/American Towers, including Rohn G-Series guyed towers and Amerite 25 Series bracket towers; lightweight freestanding aluminum towers from Universal; and packaged tower kits from TBX, which come with rotor plate, top plate, hardware pack and top section steps. **Enter "Tower" at DXEngineering.com to view your options.**



DXE-2X7



DBO-OB10-5M-P



### Yagi Antennas

Elevate your contesting prowess with a high-performance HF Yagi antenna. Our lineup includes DX Engineering's own 20/15/10M Skyhawk™ and 17/12M Skylark™; rugged EAntenna Yagis exclusively offered in North America by DX Engineering; and more than 60 elite directional Yagi antennas German-engineered by OptiBeam. **Enter "Yagi" at DXEngineering.com to find antennas, Yagi stacked systems and other accessories.**



### Coaxial Cable and Tool Kits

DX Engineering low-loss cable assemblies are available in standard lengths with our patented PL-259 connector. Use the online Custom Cable Builder at DXEngineering.com to build assemblies to your exact specs or purchase by the foot or in bulk spools. Plus, get everything you need to prep and install soldered, crimp-on or Snap-N-Seal® connectors on your coax. Complete kits include cable strippers, grippers, replacement blades, braid trimmer, cable shear and carrying case. Individual tools also sold separately.

### Free Standard Shipping for Orders Over \$99\*.

If your order, before tax, is over 99 bucks, then you won't spend a dime on shipping. (Additional special handling fees may be incurred for Hazardous Materials, Truck Freight, International Orders, Next Day Air, Oversize Shipments, etc.).



### Showroom Staffing Hours:

9 am to 5 pm ET, Monday-Saturday

### Ordering (via phone):

8:30 am to midnight ET, Monday-Friday

9 am to 5 pm ET, Weekends

### Phone or e-mail Tech Support: 330-572-3200

8:30 am to 7 pm ET, Monday-Friday

9 am to 5 pm ET, Saturday

All Times Eastern | Country Code: +1

DXEngineering@DXEngineering.com

**800-777-0703 | DXEngineering.com**



We're All Elmers Here! Ask us at: [Elmer@DXEngineering.com](mailto:Elmer@DXEngineering.com)  
Email Support 24/7/365 at [DXEngineering@DXEngineering.com](mailto:DXEngineering@DXEngineering.com)



# DXcursion of a lifetime!

We are a nonprofit, global Christian media organization that creates and distributes content over the radio and internet in more than 200 languages. We are looking for technical people (especially RF engineers and propagation specialists) who want to bring a message of hope to the world.

Spend a few weeks, months or even years living in exotic parts of the globe investing your talents to make a lasting difference. Join our team in the Pacific, the Caribbean or Africa to help us get our message out to the world over high-powered AM, FM and shortwave transmitters.



Visit us at [twr.org/serve](http://twr.org/serve), email us at [opportunities@twr.org](mailto:opportunities@twr.org) or give us a call at 919-459-3805 for more information. If you're ready to get started, go to [serve.twr.org/start-form](http://serve.twr.org/start-form) to apply.

# W1AW's QSL File

Every month, W1AW receives hundreds of QSL cards from hams all over the world, confirming contact with the Hiram Percy Maxim Memorial Station at ARRL Headquarters. Maybe you'll recognize an on-air friend — or even yourself — among these recent cards.



# Escape with the TM-281A

On or off the road, Kenwood's TM-281A is a mobile radio you can always count on.



As tough as nails, this MIL-STD-compliant transceiver delivers powerful performance, excellent audio clarity, and a host of advanced features. It offers superb operating ease day or night thanks to the large backlit LCD and illuminated keys. So the next time you take off, take the TM-281A.

# KENWOOD

Customer Support: (310) 639-4200  
Fax: (310) 537-8235

[www.kenwood.com/usa](http://www.kenwood.com/usa)



ADS#01615



Scan with your phone to  
download TM-281A brochure.

# Build Your Own **Open-Wire Line**

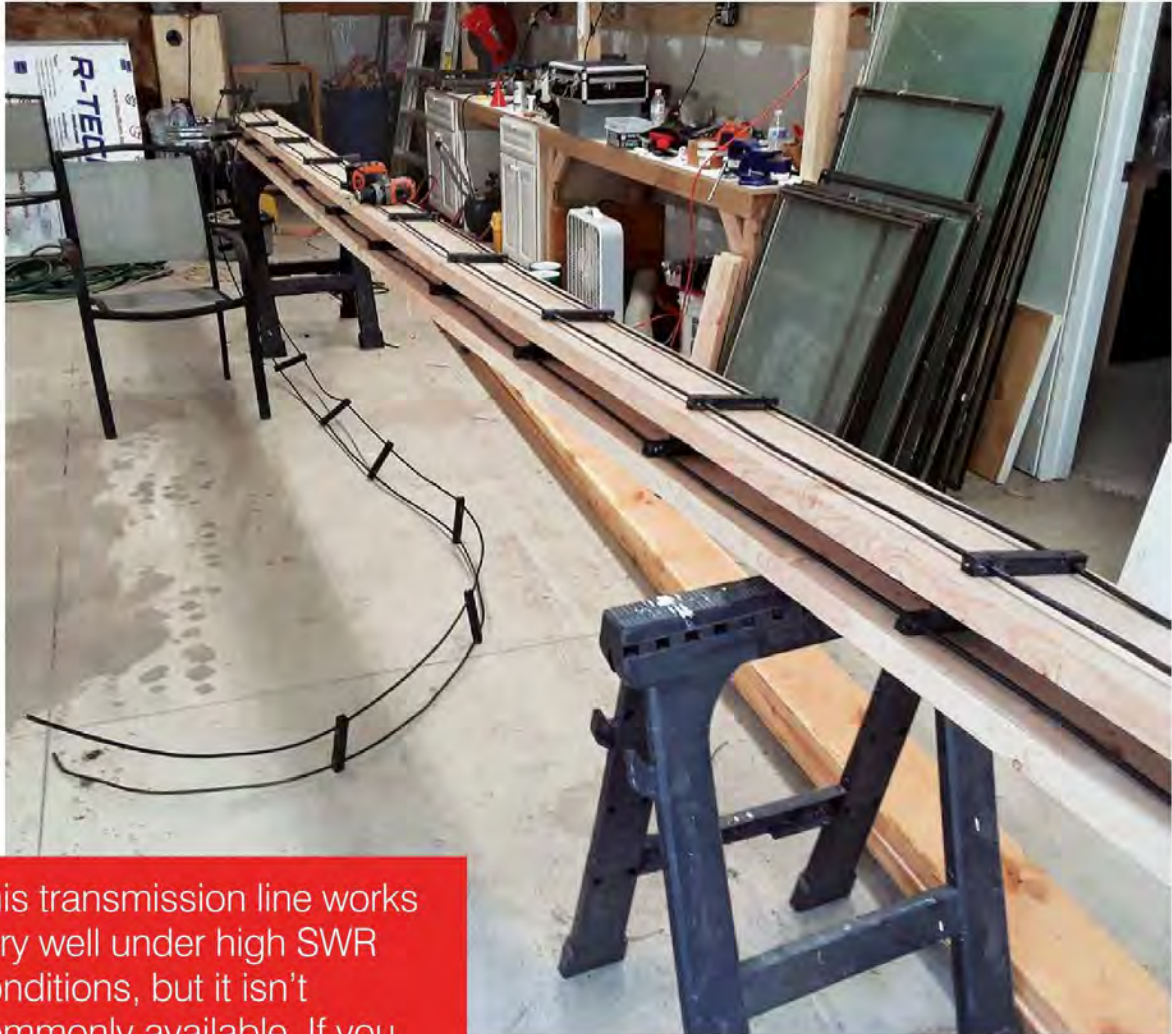

This transmission line works very well under high SWR conditions, but it isn't commonly available. If you can't buy it, build it!

Open-wire line with spacers every 2 feet, shown under construction.

## **Robert J. Zavrel, Jr., W7SX**

Amateurs have been building their own open-wire feed lines for decades, and there are many variations on the same theme. Perhaps the greatest incentive for choosing open wire and/or ladder line over coaxial lines is to reduce transmission line loss, especially for operation under high SWR conditions. Table 1 shows a comparison of three basic types of transmission line. This is how I built a particularly rugged line that is rated for high power and is more than capable of withstanding the ravages of weather. You don't need to follow my approach exactly; adapt my technique to your situation and the materials (and tools) you have on hand.

## **Materials**

My line uses #6 AWG stranded aluminum outdoor black wire. Electrical wire specified for outdoor uses polyethylene (XHHW) insulators and black improves the resistance to UV solar radiation. I also chose polyethylene plastic for the spreaders to minimize dielectric losses.



**Table 1****Summary of Relative Advantages and Disadvantages of the Three Basic Types of Lines**

Type	Line Loss	Ease of Installation	Arcing Risk	Aging	Noise Pick-Up	SWR Tolerance
Coaxial	Worst	Best	Worst	Worst	Best	Worst
Ladder Line	Better	Better	Better	Better	Better	Better
Open Wire	Best	Worst	Best	Best	Worst	Best

Polyethylene is notorious for not bonding well with glue. However, I did find an adhesive that works well (3M part number 4693H), but it requires some care. The 5-ounce tube was just enough for 200 feet of line using 100 spreaders.

For spreader material, I selected  $\frac{3}{8}$ -inch-thick sheets of black polyethylene. Polyethylene is very easy to cut on a wood-cutting table saw using standard wood-cutting blades. I also used a standard wood-cutting dado set to cut the grooves to accept the wires and provide a tight fit into the plastic. When using smaller wire, a standard wood-cutting blade might also serve to cut the groove in the polyethylene. You want a snug fit, so some experimenting will likely be necessary to find the right groove width and depth for a given wire.

Using #6 AWG aluminum results in a slightly lower loss than #12 AWG copper. However, the much larger aluminum wire is stronger than copper and lighter for its strength. A #6 AWG copper wire would be heavier, but would provide a super low-loss line.

Each spreader comprises two polyethylene plastic parts machined on a woodworking table saw. The center-to-center spacing of the wires, and thus also the dado grooves, is  $4\frac{1}{4}$  inches. This provides for a 450  $\Omega$  line impedance allowing seamless connection to commercial 450  $\Omega$  ladder line. When the two parts are glued together, the spacers are  $\frac{3}{4} \times \frac{3}{4} \times 5\frac{1}{4}$  inches with the wires sandwiched into the dado grooves.

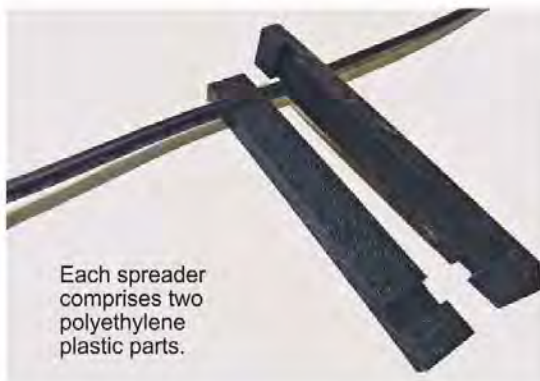

Each spreader comprises two polyethylene plastic parts.

For my construction platform, I used 20-foot-long, 2 x 8 inch standard framing lumber boards supported by sawhorses at each end.

### Building the Line

The first step is to cut the wires. I built the line in 100-foot sections, then connected them together when installing the line using standard splice/reducers. The two lines are stretched reasonably tight on the board and held in place with C clamps. I employed unglued spreaders to keep the spacing accurate and constant over the length.



Framing lumber supported by sawhorses at each end make the construction platform.

The spacers are placed every 2 feet along the line length. The adhesive is applied to the lower part, including inside the groove. A bit of experimenting with the amount will yield how much to apply as you continue. Adhesive is also applied to the upper half of the spacers' grooves. I then used 1 1/4-inch sheetrock screws to hold the assembly in place while the adhesive set up. The screws self-tap through the two plastic spacer pieces and also down into the wood.



I used two screws per spacer, each close to the wire on the inside of the spacers.

Connect transmission sections together with standard splice/reducers.

When finishing one run, I simply flipped the board over and continued assembly in the opposite direction on the other side of the board. I then placed another board on top and did the same thing. Each board will then have a bit more than 40 feet of finished line. Three boards will hold the entire 100-foot segment. I wore rubber gloves to keep the industrial-strength adhesive off my hands. I let the adhesive set for 24 hours under the pressure of the screws. Then, I simply removed the screws and the line was finished.

At 7 MHz, 500 feet of this line has just 0.25 dB of matched loss. With an SWR of 15:1 on the line, my total loss was about 1 dB. The losses at 1.8 and 3.5 MHz are even lower. For matched conditions, a 450 Ω line could use 9:1 baluns at either end and thus offer a direct replacement for a 50 Ω coaxial run.

### Installing the Line

I hung the line from trees at least 10 feet high to prevent contact with moose antlers (a common occurrence on my remote property). There are many ways of hanging the line. I used 1 x 1 inch lengths of polyethylene attached to the wires with 3/16-inch wire rope clamps with the saddles of the clamps biting into the wire insulation and tightening them down to the poly support. Then I used an eye bolt screwed into a tree limb (or offset from the trunk) and a small rope threaded through the eye hook to raise or lower the line. On one 70-foot run, I utilized a counterweight and pulley to compensate for snow and wind loads.

The adhesive used in the spacers is not strong enough for line support, so I used a larger piece of polyethylene and fastened them to the plastic with 3/16-inch wire rope clips. Then I used aluminum U-channel to connect the assembly to a rope. Rope clips come with U bolts, which I replaced with galvanized 1/4-inch bolts and nuts.

The rope passes through a pulley at the top of a 4 by 6 pressure-treated post and is then tensioned with a counterweight. The U-shaped bend in the transmission line allows for slack to compensate for wind and snow loads as well as making it possible to raise and lower the line for maintenance. The line is then routed up and over the post before being routed to the metal building that houses the shack. I used 1/2-inch electrical conduit for each wall feed-through.

I relied on electrical putty to seal the hole on the outside of the electrical conduit to keep bugs out. The spreader shown was installed after the two wires were routed from the inside of the building. C clamps held the two spreader parts together while the adhesive set. Two splice/reducers below the C clamps connect the two sections of the line. This also allows a disconnect for lightning protection when the system is not in use. The passage through the wall with metal exterior has a negligible effect on the open wire line.



Rope clips come with U bolts.



An aluminum U channel connects the assembly to a rope.



The rope runs through a pulley and is then tensioned with a counterweight seen against the post in the foreground. Half-inch electrical conduit comprises the shack wall feed-throughs.



A collection of counterweights made from concrete poured inside 3-inch standard ABS plastic plumbing pipes.

However, care must be taken to eliminate possible arc-over. Insulated wire and electrical conduit are more than adequate for this concern.

### Homebrew Counterweights

My go-to method for making counterweights is to start with 2½-foot lengths of 3-inch-diameter standard ABS plastic plumbing pipe. I use a single piece of rebar and stand it up on a board and pour a few inches of dry concrete mix into it, then pour a few ounces of water on top of the dry concrete. I keep repeating until the pipe is filled. I recommend pouring the dry concrete into a bucket and using a small container to gradually pour the dry concrete into the pipe. This will prevent concrete from spilling all over the work site and making a mess.

I place the rebar into the wet concrete when it can stand alone. Let the weight dry for 2 or 3 days in the vertical position with no disturbance. My last step is to weld a ⅜-inch eye bolt to the rebar to accept the rope. Of course, it's also possible to bend rebar into a U shape and avoid the hook. Finally, spray-paint the exposed metal with rust-preventing paint.

The 2½-foot weights weigh about 20 pounds. The two outside the container are 3⅓ feet long and weigh about 30 pounds. I use the heavier weights to suspend the heavier transmission line and wire antennas longer than about 200 feet. The plastic skin on the weight is softer than raw concrete or steel, which is friendlier to the tree trunk when the weight sways back and forth in the wind.

I installed a 75-foot run up to a small wooden shed that will house antenna relays and tuning circuits. It will also be the switching and control point for the final 200-foot run to the top of the property (next year). The final installation will have about 400 feet of open wire line to the very top of the property.

Bob Zavrel, W7SX, has been licensed since 1966 and has held an Amateur Extra class license since 1974. He is a life member of ARRL and has been an ARRL technical advisor since 1984. He is a Senior Member of the IEEE, with 40 years experience in RF engineering and engineering management. Bob holds a BS in physics from the University of Oregon and is a adjunct professor of electrical engineering at Gonzaga University. He wrote the ARRL publication *Antenna Physics: An Introduction*, authored over 70 technical publications, and has been awarded six patents. He has earned DXCC Honor Roll for both mixed and CW modes. Bob currently operates an engineering consulting business specializing in RF technology and applications. You can reach him at [w7sx@arrl.net](mailto:w7sx@arrl.net).

For updates to this article, see the [QST Feedback page](http://www.arrl.org/feedback) at [www.arrl.org/feedback](http://www.arrl.org/feedback).



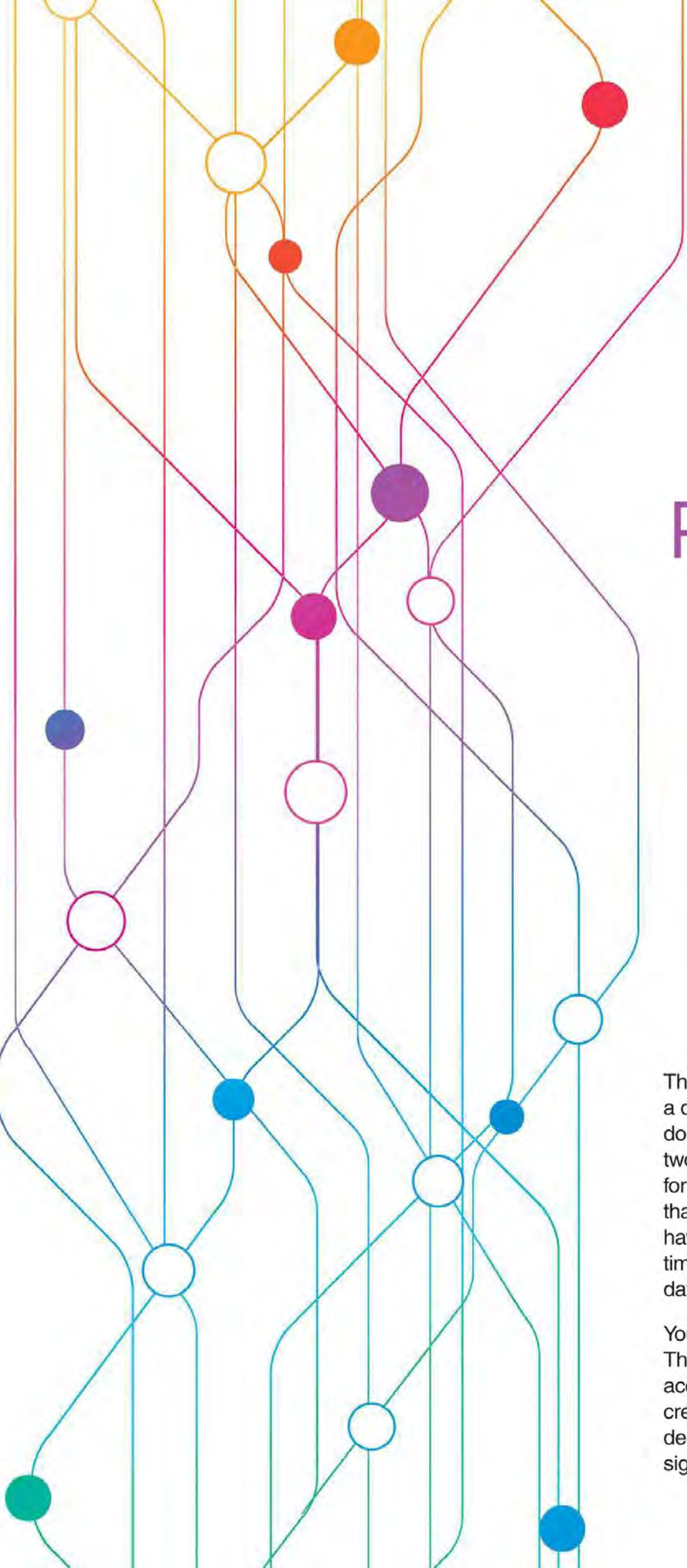

# Using Integrated Circuits to Add Propagation Delays

**In digital circuits, you sometimes need to delay one signal with respect to another. Here's how.**

**Klaus Spies, WB9YBM**

There are certain applications where delaying a digital signal is desired. For instance, what do you do when you have a circuit requiring two inputs — such as an “enable” command for downstream circuitry, and a data input for that same downstream circuitry — but all you have is a single signal? In most cases, the timing of the “enable” signal with respect to the data is critical for proper circuit operation.

You need a way to turn one signal into two. This is not as strange as it may sound. You can accomplish this by splitting off the main signal, creating a secondary signal, and then providing delay for either the main signal or the secondary signal. There are a few simple ways to do this.

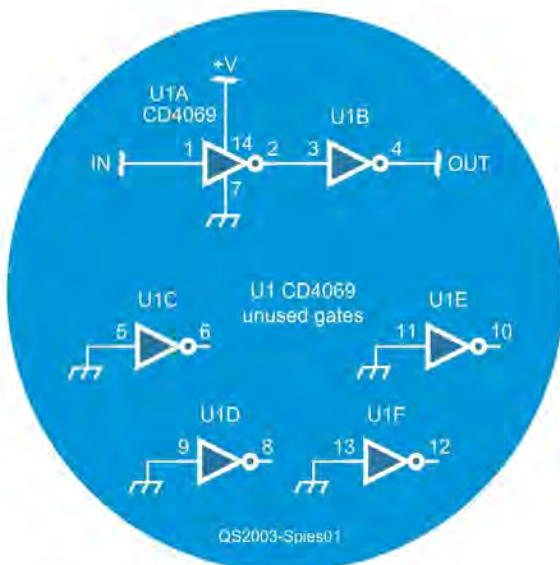

**Figure 1** — Using cascaded gates to increase propagation delay.

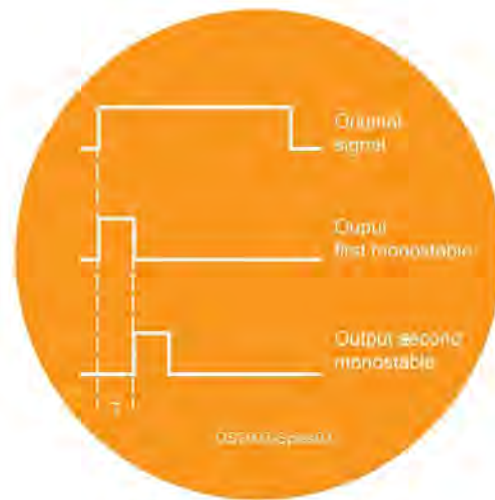

**Figure 3** — A diagram of propagation delay timing.

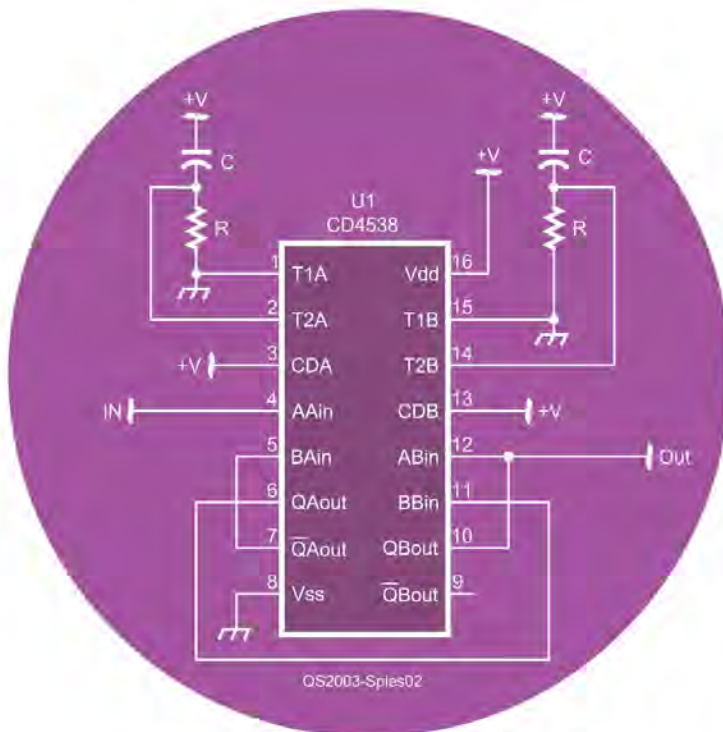

**Figure 2** — Using monostable oscillators to add propagation delay.

Figure 1 shows the easiest approach: chaining two or more integrated circuits together. Each gate adds a certain amount of delay, which can be found in the data sheet of the integrated circuit used. As an example, the CD4069/MC14069 hex inverter shown in Figure 1 has a per-gate typical propagation delay of 25 – 55 nanoseconds, depending on power supply voltage. Note that when using inverters, an even quantity of gates is necessary to preserve the same logic sense, and the output has the same pulse length as the input.

### For An Even Longer Delay

If longer pulse lengths or longer delays are needed, as is sometimes the case for noise reduction or switch debouncing circuits, a monostable oscillator can be used. Figure 2 is an example of a CD4538/MC14538 dual oscillator. If we want to delay the rising edge of a signal, we'll have the first monostable trigger from the leading edge. Using the formula  $T = RC$  to calculate the time constant, we can set the length of the time delay needed. The second monostable is triggered from the lagging edge of the first monostable after the first delay time has elapsed. As the time constants are predetermined by  $T = RC$ , they do not exactly duplicate the incoming signal. However, because our concern is generating leading edge time delay of a signal, an exact duplicate is not necessary in this application. Figure 3 shows a timing diagram of this approach.

There are more sophisticated ways of delaying signals that may be more appropriate in critical designs. However, for many ham-related projects, the simple approaches shown here are effective and inexpensive.

Klaus Spies, WB9YBM, became interested in radio in the 1970s by listening to shortwave and VHF/UHF. He received his first ham license in 1975 and currently holds a General-class license. Klaus has also earned almost every license issued by the FCC, a few of which don't even exist anymore. On the professional side, Klaus's career has followed a technical path as a research and development electronics engineering technician, starting at Motorola and progressing through several other companies. Currently, he is self-employed as an electronic circuit designer and author, developing circuits from concept through manuscripts for several technical journals, including *QST*, *CQ*, *73*, *Nuts and Volts*, *RADCOM*, and others. You can reach Klaus at [wb9ybm1@yahoo.com](mailto:wb9ybm1@yahoo.com).

For updates to this article, see the *QST* Feedback page at [www.arri.org/feedback](http://www.arri.org/feedback).



# “Leaky” Antenna Switches

When switching between equipment and antennas, it is important to consider the RF isolation your switch provides.

## Ellwood (Woody) Brem, K3YV

Any ham who has two or more antennas has probably considered using an antenna switch, which allows you to switch your radio from one antenna to another without having to connect and reconnect antenna cables each time you change antennas. Some modern radios have built-in antenna switches, and quite a few antenna tuners do as well. And then there are basic standalone switches and even remote outdoor switches.

Besides switching multiple antennas to one radio, antenna switches can also be used to switch multiple radios to one antenna. The problem with switching radios is keeping the RF output signal of the transmitting radio from causing damage to the off-line radio or other equipment (such as a receive preamplifier), which can be damaged if too much power leaks through the switch. Every switch has some degree of leakage between the selected port and the unselected port(s). So, RF from a radio transmitting through one port will leak through to the switched-off port. To safeguard your gear from inadvertent damage, the antenna switch must provide a high degree of isolation between its switched-on port and its switched-off ports.

## How Much Leakage is Too Much?

How much power can a receiver accept without damage? Unfortunately, many manufacturers don't specify a maximum input signal level. Radio manufacturers who do specify a safe input power level generally limit the maximum to between +10 and +20 dBm. I have always used +10 dBm, to be on the conservative side. That translates into 0.01 W or 1.0 V peak RF voltage in a 50 Ω system. So, considering +10 dBm as our limit of maximum input power, how much isolation is required in our antenna switch?

The maximum output power allowed by the FCC for amateur stations is 1,500 W, which is +61.76 dBm. If we are to limit the input power of our offline radio to



The MFJ-2703 switch.

+10 dBm, then we need at least 51.76 dB of isolation. That's a lot of isolation.

Generally, a switch will have higher port-to-port isolation at HF than VHF, with the isolation getting progressively less as the frequency increases. Unfortunately, not all antenna switch manufacturers specify their isolation. Among those that do, some manufacturers specify their switch isolation to be greater than 50 dB at HF, while others specify greater than 70 dB isolation. We have shown that nearly 52 dB of isolation is necessary when running 1,500 W. Therefore, switches with 50 dB of isolation are extremely marginal. Switches with 70 dB of

**Table 1**  
Measured Isolation in dB Between Switch Ports

Frequency (MHz)	Isolation (dB)					
	Pos 1		Pos 2		Pos 3	
	Port 2	Port 3	Port 1	Port 3	Port 1	Port 2
3.0	129	122	129	129	121	128
4.0	129	116	127	125	115	127
5.0	129	111	125	117	110	124
7.5	122	102	117	111	103	116
10.0	117	97	109	104	97	110
12.5	112	93	105	99	93	106
15.0	112	91	107	96	90	105
17.5	114	88	105	93	87	103
20.0	113	86	102	91	85	101
22.5	109	84	100	92	84	99
25.0	107	82	96	90	82	98
27.5	109	81	94	88	80	96
30.0	108	80	92	86	79	92

isolation ensure a good safety margin for high-power operation.

## Measuring Isolation

While verification of switch isolation is desirable, measuring switch isolation is not easy. Most hams do not have test equipment sensitive enough to measure 50 to 70 dB of attenuation. Fortunately, I had access to highly sensitive laboratory test equipment, which allowed me to achieve accurate isolation readings.

I recently purchased an MFJ-2703 three-way antenna switch. Its planned use is to select between my main station (which can run up to 1,500 W) and my backup equipment (which can run up to 600 W). The third port on this switch is available for a future radio. MFJ specifies the Port-1 to Port-2 isolation to be greater than 70 dB at HF, but they do not specify isolation for the third port.

I measured the port-to-port isolation using an RF signal generator and a spectrum analyzer, as shown in Figure 1. Specifically, I connected an RF signal generator to the common port of the switch. The switched-in port (through-port) was terminated in 50 Ω. A laboratory-grade spectrum analyzer was connected to each of the two unselected ports, one port at a time. The amount of leakage measured from each unselected port was read directly on the spectrum analyzer and recorded. The difference in signal level, expressed in dB, between the input signal and the leakage signal is the port-to-port isolation. Each port in turn was selected as the switched-in port, while leakage levels were measured in each un-selected port. Thirteen individual frequencies between 3 and 30 MHz were measured. Table 1 shows the tabulated measured isolation.

My measurements show that the MFJ-2703 switch has its highest isolation between Ports 1 and 2. The highest measured isolation was 129 dB from 3 MHz up to 5 MHz, with the least isolation being 108 dB at 30 MHz. Note that this confirms our expectation of more leakage at higher frequencies. The MFJ-2703 exceeds our minimum isolation requirement by more than 50 dB, which gives us an excellent safety margin at 1,500 W. Even the worst-case isolation from Port 3 to Port 1 of 79 dB at 30 MHz provides a margin of 27 dB at 1,500 W. Other switches could be measured using the same technique.

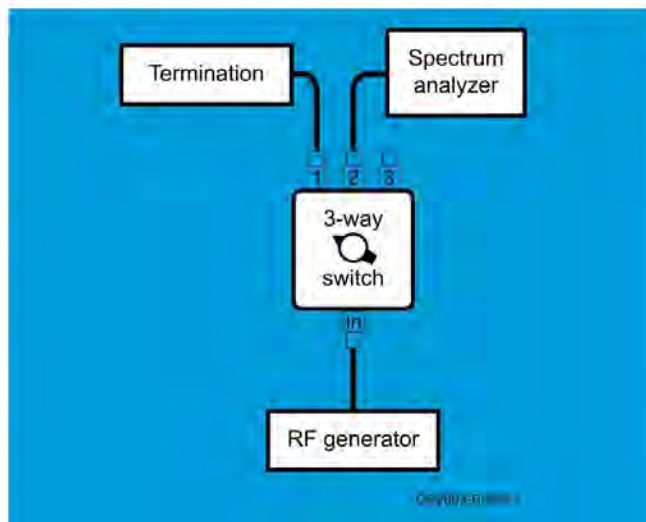

**Figure 1** — A diagram of the author's isolation test setup, which consists of a Keysight N5173B RF generator, a Keysight N901A spectrum analyzer, a 50 Ω termination, and the MFJ-2703 three-way switch.

## Grounded Ports

Many antenna switches, such as the MFJ-2703, have their unselected ports shorted to ground. Port-grounding antenna switches offer protection from electric discharges due to rain or snow static, as the offline radio's input is always at ground potential. Anyone who has had arcing across their antenna connectors on a snowy winter day will appreciate this. In my case, I use a shorted PL-259 connector on the unused third port of my MFJ-2703, which I select when I am off the air. That ensures that the antenna feed line and my two transceiver antenna ports are all grounded when I'm not on the air. This is a great side benefit of an external (stand-alone) antenna switch.

Antenna switches offer convenience in station operation and protection from static discharge. As with all antenna systems, keep the voltage standing-wave ratio (VSWR) low, don't exceed the power limitation of your feed line or antenna, and make sure your antenna switch has enough isolation to protect your equipment.

Woody Brem, K3YV, has been a ham for 57 years. He is an RF/microwave engineer and holds a Master's degree in Electrical Engineering from Penn State University. Woody lives in Spring Mills, Pennsylvania with his wife, Sharon Gaisler, N3SG, and their two cats, Rho and Theta, the Gamma sisters (named after the complex reflection coefficient of transmission line theory). You can reach Woody at [eeb3568@gmail.com](mailto:eeb3568@gmail.com).

For updates to this article, see the **QST Feedback** page at [www.arrl.org/feedback](http://www.arrl.org/feedback).



# Batteries for the Elecraft KX3 and Other Low-Power Radios

How to choose batteries for portable operation.



**Eliot Mayer, W1MJ**

I assembled an Elecraft KX3 low-power (QRP) transceiver from the no-solder kit, and have enjoyed operating portable with it, from ARRL Field Day on a mountaintop in New Hampshire to the shores of Easter Island as CE0Y/W1MJ (see the sidebar, “Must-Haves for Portable Operation,” for some tips). Choosing a battery for these field operations with the KX3 was not obvious. Choices for other QRP radios are similar, but there are differences too.

## Battery Types Considered

The KX3 has an internal battery case for eight AA cells, but I did not find this a very useful feature. I was also concerned about having this case pressing directly against the delicate surface-mount components in the radio. Elecraft said that there were no reported reliability issues caused by this arrangement. Even so, I removed the holder and turned it into a spare external battery pack that holds non-rechargeable, long shelf life lithium cells. It serves as a backup to my rechargeable batteries.

The selection of rechargeable batteries for a QRP radio depends mainly on weight and budget considerations. The radio specifications and intended usage also factor in. I carried the radio up the 4,000-foot Galehead Mountain in New Hampshire at age 60, so weight was a big factor for me. Also, because I transmit only with the traditional QRP upper limit of 5 W, I can use lower voltages than the KX3 requires for operation at 10 – 15 W. Check the manual about power supply requirements for other radios.

Table 1 summarizes the most common rechargeable battery options. Lithium-ion batteries are very lightweight, but they are available only in multiples of the 3.7 V cell voltage. An 11.1 V battery works well for a KX3 at 5 W operation.

## Must-Haves for Portable Operation

For battery-powered portable operations, be sure to bring spare batteries, even if they don't match the capacity of your primary source. You may just need enough energy to finish a contact and end your session.

Many hams log contacts using computers, but bringing along laptops, smartphones, or GPS devices means more battery consumption. To keep things simple, always take along a compass and map for navigating, and use a pen and paper for logging contacts.

Weatherproof carrying cases for equipment can help protect expensive gear. To protect yourself, bring bug spray, sunscreen, a first aid kit, and water on every portable excursion.



**Table 1**  
**Summary of Rechargeable Battery Types**

Battery Type	Cost	Weight	Comment
14.8 V lithium ion	High	Lowest	Requires voltage reducing circuit
11.1 V lithium ion	High	Lowest	Limits KX3 to 5 W output
12.8 V lithium iron phosphate (LiFePO <sub>4</sub> )	High	Low	Good overall choice; author's favorite
12 V sealed lead acid	Low	High	Best choice on a budget

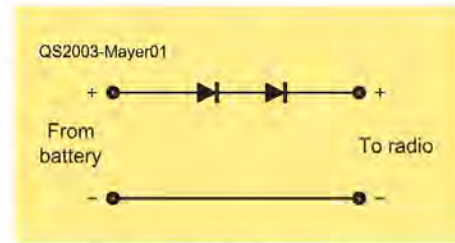

**Figure 1** — A simple battery voltage reducer.

A 14.8 V lithium-ion battery can run the KX3 at its full 15 W output. However, its voltage when fully charged exceeds the KX3 15 V power supply limit, so a voltage reducer or regulator is needed. Two series diodes (see Figure 1) rated at least 2 A and 25 V in the power cables should suffice. 1N5402 diodes (Digi-Key 1N5402RLGOSCT-ND) are appropriate for this task.

Phil Salas, AD5X, developed a circuit with two such diodes and a relay that bypasses the diodes when the battery voltage is below 15 V (see his article in the April 2015 issue of *QST* for more information). I also found a solution using an efficient switching regulator in KR7W's SOTA Adventure Blog ([www.kr7w-sota.blogspot.com/2013/01/qrp-ops-battery-power-fyi.html](http://www.kr7w-sota.blogspot.com/2013/01/qrp-ops-battery-power-fyi.html)). However, looking at the flat spot from 13 V to 15 V in Figure 2, it appears that the AD5X and KR7W circuits might not extend KX3 operating time per charge beyond that of the simple two-diode approach. More KX3 power consumption data is available on the [www.arrl.org/qst-in-depth](http://www.arrl.org/qst-in-depth) web page.

### Supply Current vs. Supply Voltage

Battery capacity is measured in ampere-hours (Ah). A 5 Ah battery should nominally deliver 1 A for 5 hours. For more on battery capacity, see Rick Palm's, K1CE, "Public Service" column in the March 2015 issue of *QST*. When selecting a battery for your radio, consider that its power supply current may vary with battery voltage.

The current-voltage relationship goes in opposite directions on different QRP radios. According to measurements by Clinton Turner, KA7OEI, the Yaesu FT-817 draws more current as the power supply voltage increases ([www.ka7oei.com/ft817\\_pwr.html](http://www.ka7oei.com/ft817_pwr.html)). My own measurements show that the KX3 current



decreases as the voltage increases. For 5 W operation, the KX3 supply voltage can range from 9 to 15 V dc, and power supply current is significantly lower at 15 V than at 9 V. This is probably because efficient switching voltage regulators are used for some of the radio circuitry. Switchers draw approximately the same power independent of the input voltage, so current goes down as voltage goes up.

Figure 2 shows my KX3 measurements with the radio set for 5 W transmit power on 14.060 MHz. The backlight, preamp, and receiver isolation amp (RX ISO) were all turned off — they would consume an additional 53 mA when on. I calculated the average power at 25% transmit duty cycle; this duty cycle is based on active Field Day CW operation using full-break-in keying, where the radio switches to receive mode between every dit and dah. In the semi-break-in mode, the radio uses more than double the power between dits and dahs than it uses during receive.

### Battery and Charger Suppliers

I strongly recommend buying battery packs that include protection against over-charging, over-discharging, and over-current. One example is the LiFePO<sub>4</sub> 18650 battery, rated at 12.8 V and 4,500 mAh, available from [www.batteryspace.com](http://www.batteryspace.com)

## UN38.3 Battery Certification

Occasionally, you'll read stories about lithium batteries in laptop computers, cell phones, and other devices suddenly overheating and bursting into flames. These incidents are rare, but they are destructive and even potentially life threatening when they occur.

A number of years ago, the United Nations established strict standards concerning transportation safety when it comes to lithium metal and lithium ion cells and batteries. These standards have been adopted by most nations.

For a battery design to receive a UN38.3 certification, it must pass a series of rigorous tests that subject the battery to:

- Low air pressures
- Extremes of heat and cold
- Powerful vibrations
- Severe impacts
- External short circuits
- Crushing
- Overcharges
- Forced discharges

Failure to pass any of these tests means that a battery cannot be shipped by air, rail, boat, or vehicle, or be used to power a device that might be transported in this fashion.

and other battery and battery accessory suppliers, like Bioenno Power ([www.bioennopower.com](http://www.bioennopower.com)) and Powerwerx ([powerwerx.com/batteries-chargers](http://powerwerx.com/batteries-chargers)).

The battery is UN38.3 certified, which means that the battery is safe to transport (see the sidebar, "UN38.3 Battery Certification"). It is wise to purchase batteries with this designation. It is also a good idea to purchase a matching charger, as recommended by the seller. Clicking "Related Products" on the Battery Space web page for the 12.8 V battery shows such a charger. Other chargers, such as solar chargers, are also okay as long as you follow the charging specifications for the battery.

Not surprisingly, it is easier to find batteries online these days than in physical stores. An online search will show many more suppliers than the few I have mentioned, but physical battery stores do still exist. For example, check the store locator for Batteries + Bulbs to see if one is in your area ([www.batteriesplus.com](http://www.batteriesplus.com)).

It is also possible to assemble your own battery pack from components, just like my friend Jacques Patry,

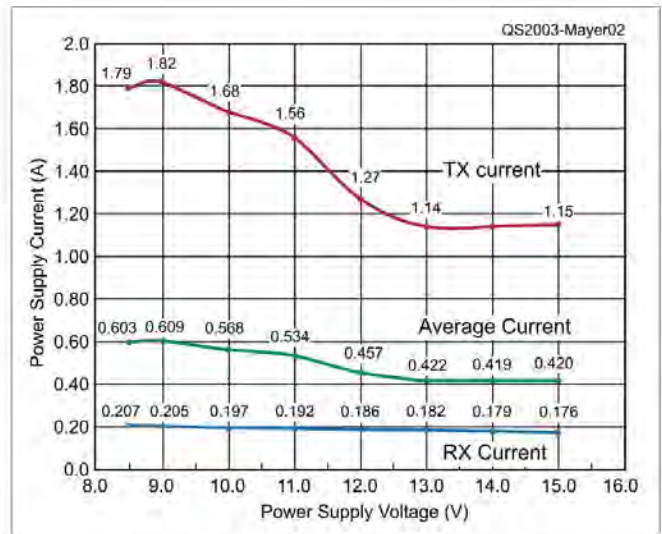

**Figure 2** — Power supply current versus voltage for the KX3. Other QRP radios have very different current versus voltage behavior.

WD1I, does. He shops on sites like [www.aliexpress.com](http://www.aliexpress.com) and [www.banggood.com](http://www.banggood.com). Jacques mentions that you should be sure to include a battery maintenance system (BMS) board. It prevents over-charge and over-discharge. It also equalizes the charge on each cell and maintains equilibrium.

## Summary

Battery selection for your QRP radio depends primarily upon your budget, and on the importance of weight for your planned usage. Sealed lead-acid batteries are the best choice for hams on a budget. Lithium iron phosphate (LiFePO<sub>4</sub>) batteries are much lighter, but are more expensive. Lithium-ion batteries are priced similar to lithium iron phosphate batteries, and are even lighter, but the available voltages are not always a good match for the radio. I hope this helps you select a battery for your QRP radio.

Eliot Mayer, W1MJ, is an electrical engineer with a BSEE from the University of Massachusetts at Amherst and an MSE in management from the Gordon Institute of Tufts University. He works on the design and manufacturing of medical imaging equipment at Analogic in Peabody, Massachusetts. Eliot was first licensed as a Novice in 1970 with the call sign WN1MYK. His ham radio activities include QRP holiday-style DXpeditions, operating a K3 radio from his condo home station, guest operating at the high-power stations of fellow Yankee Clipper Contest Club (YCCC) members, and 2-meter FM on his daily commute. His favorite ham event is ARRL Field Day. His radio operations can be found at [www.w1mj.com](http://www.w1mj.com). You can reach Eliot at [eliotmayer@yahoo.com](mailto:eliotmayer@yahoo.com).

For updates to this article, see the QST Feedback page at [www.arrl.org/feedback](http://www.arrl.org/feedback).



## Close Up

# Electrolytic Capacitors

Even in the era of surface-mount devices, electrolytic capacitors with through-hole wire connections are still widely used. Electrolytics are polarized capacitors with positive and negative leads separated by a dielectric. As some kit builders learn the hard way, installing an electrolytic capacitor “backwards” can be problematic, to say the least!

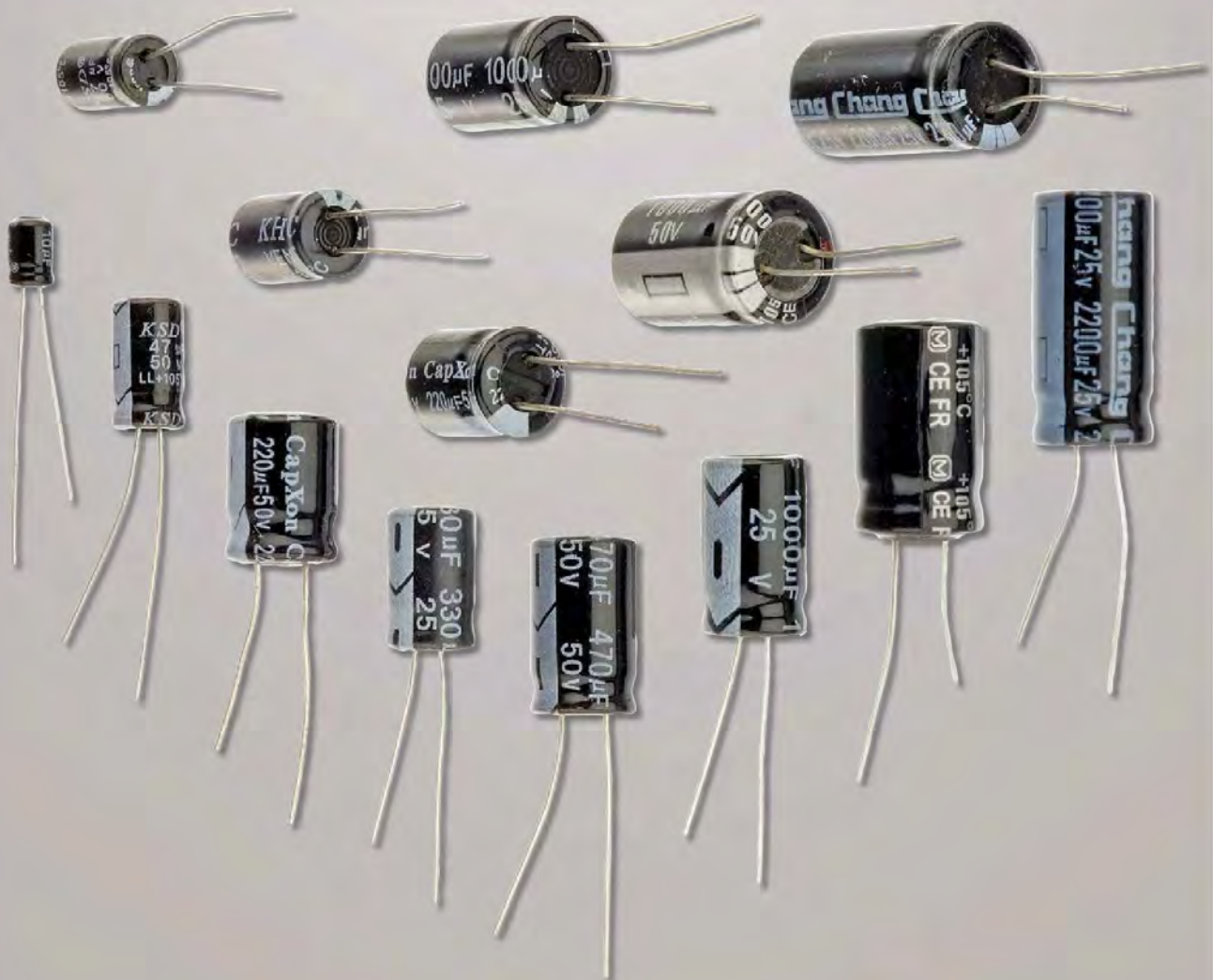

## Product Review

# Xiegu G90 HF Transceiver



Reviewed by Phil Salas, AD5X  
ad5x@arrl.net

Xiegu's G90 HF transceiver fills the void between QRP (usually 5 W output) and 100 W radios. Let's take a look at this interesting product, which is distributed and supported by MFJ Enterprises in the US.

### Overview

The Xiegu G90 is built on a downconverting software-defined radio (SDR) platform using a 24-bit 48 kb/s sampling analog-to-digital/digital-to-analog converter. A limited bandwidth signal is mixed down directly to baseband, where the signal processing occurs — it is a direct conversion transceiver. (See the *QST* in Depth web page, [www.arrl.org/qst-in-depth](http://www.arrl.org/qst-in-depth), for more information.) The G90 transmits on the 160-through 10-meter ham bands and has a general-coverage receiver that tunes continuously from 500 kHz to 30 MHz. Transmit power is adjustable from 1 to 20 W, and operating modes include SSB, CW, and AM, as well as digital modes using an external computer.

The G90 includes many features typically found on desktop transceivers, such as split-frequency operation, a built-in SWR bridge, an automatic antenna tuner, a receiver preamp and attenuator, a digital noise blanker, a CW decoder, and variable band-pass audio filters. Additionally, there is a built-in CW keyer and a speech processor for the SSB operator. A 1.8-inch color TFT LCD screen simultaneously displays everything necessary during operation, and it even includes a 48 kHz wide spectrum display and a waterfall display. There is an excellent-sounding top-mounted speaker.

### Bottom Line

With 20 W of output power and a wide-range internal auto tuner, the Xiegu G90 is a capable transceiver in a well-thought-out, compact package that will interest the portable operator.

## Interfaces and Controls

The G90 looks like a miniature version of my Icom IC-706MKIIG 100 W transceiver. The front panel can even be remotely mounted using the included 1-meter-long DB9 extension cable! And while the G90 is loaded with controls and interface connectors, everything is easily accessible.

Figures 1 and 2 show the various connectors. On the rear, you'll find a standard SO-239 antenna connector, along with 3.5-millimeter stereo jacks for **KEY** (manual, paddle, or external keyer) and **COM** (to update firmware in the main unit). There's also an **I/Q** output for external I/Q channel processing or display (an add-on panadapter had been announced, but was not available when this was written). The eight-pin mini-DIN **ACC** jack is for amplifier interfacing and external audio in/out for digital modes. Finally, there is a mini-Tamiya power connector and a ground connection.

On the left side of the front panel, there are two 3.5-millimeter stereo jacks for headphone and front-panel firmware updates. The microphone plugs into an RJ45 jack on the right side of the front panel. On the top of the radio are up/down buttons for band and mode selection.

The front panel includes 13 pushbuttons, a volume knob, a multifunction knob, and a tuning knob. The knobs have multiple uses, which I'll cover later. All buttons are clearly marked and have a good tactile feel, and most of these buttons provide additional functions depending on whether they are tapped, pushed and held, or accessed after pressing the **FUNC** button. Again — more on this later. There is a yellow LED that flashes in sync with incoming CW when you have the signal properly tuned in, a yellow LED that lights when the **FUNC** button is pressed, and an LED that lights green on receive and red on transmit. The multifunction keypad on the included microphone also permits access to all of the radio's features.

## Power Requirements

The G90 requires an external power source of 10.5 to 16.5 V dc. Although the specifications state that the power source must be capable of 8 A maximum current, actual measurements show that less than 5 A are required at maximum power. For portable operation, I prefer lithium polymer (LiPo) batteries due to their low cost and high energy capacity versus size and weight, but a 4S LiPo battery has a fully charged voltage of 16.8 V dc. I asked Xiegu about this, and they stated that the G90 will operate fine up to 17 V dc, and that a 4S LiPo battery is a good choice for portable operation.



Figure 1 — The Xiegu G90 rear panel.



Figure 2 — Connectors on the sides of the G90, near the front panel. See text for details.



Figure 3 — The G90 display.

A 10 A fused #16 AWG cable with a mini-Tamiya power connector-to-tinned bare wire ends is included with the radio. I added an Anderson PowerPole connector to the wire ends, as that is my standard dc interface. The LiPo batteries for airsoft guns use the same mini-Tamiya connector as the G90, and compatible #14 AWG power cables are readily available from airsoft suppliers. However, be careful if you purchase a prewired airsoft connector, as these cables normally have the red and black power wires reversed from the wires in the G90 power connector.

### Firmware Updates and Documentation

A 3.5-millimeter-to-USB cable is provided for firmware updates as well as computer interfacing. You must separately update the main unit and the front-panel firmware. Updating the firmware requires numerous steps, as detailed in the *G90 User Manual*. While this is a somewhat tedious process, it is not difficult.

Xiegu has been very responsive to user inputs with respect to bug fixes and feature updates. Because of these frequent changes, the documentation supplied with G90 transceivers is almost certainly outdated. MFJ maintains the latest G90 firmware and documentation on their website. There is also a very active G90 user group at [groups.io/g/XieguG90](https://groups.io/g/XieguG90) that maintains the latest firmware and documentation in the FILES section. The G90 user group is also a great resource for tips and getting answers to your questions.

### Some Additional Testing

Table 1 shows the results of testing in the ARRL Lab, with additional comments in the “Lab Notes” sidebar. In addition to the ARRL Lab tests, I did detailed testing on transmit power and current versus the transmit power setting and

**Table 1**  
**Xiegu G90, Serial Number X0419350537**

Manufacturer's Specifications		Measured in the ARRL Lab		
Frequency coverage: 0.5 – 30 MHz; transmit, 160 – 10 meter amateur bands.		As specified. On 60 meters, transmit is 5.3305 – 5.405 MHz.		
Power requirement: transmit, 8 A maximum; receive, 500 mA maximum, at 10.5 – 16.5 V dc.		At 13.8 V dc: Transmit, 4.4 A typical at maximum RF output, 2.1 A at minimum RF output. Receive, no signal, maximum volume and lights, 558 mA; minimum lights, 540 mA. Power off, 0 mA.		
Modes of operation: CW, AM, SSB.		As specified.		
Receiver		Receiver Dynamic Testing		
SSB/CW sensitivity: 1.8 – 2 MHz, 0.35 $\mu$ V; 2 – 30 MHz, 0.25 $\mu$ V.		Noise floor (MDS), 500 Hz bandwidth: <i>Preamp off</i> <i>Preamp on</i>		
		1.0 MHz	-128 dBm -136 dBm	
		3.5 MHz	-131 dBm -138 dBm	
		14 MHz	-132 dBm -138 dBm	
		28 MHz	-134 dBm -139 dBm	
Noise figure: Not specified.		Preamp off/on: 14 MHz, 17/8 dB.		
AM sensitivity: 0.5 – 2 MHz, 10 $\mu$ V; 2 – 30 MHz, 2 $\mu$ V.		10 dB (S+N)/N, 1 kHz tone, 30% modulation, 6 kHz bandwidth: <i>Preamp off</i> <i>Preamp on</i>		
		1.0 MHz	4.73 $\mu$ V 2.04 $\mu$ V	
		3.8 MHz	2.82 $\mu$ V 1.49 $\mu$ V	
		29 MHz	2.40 $\mu$ V 1.66 $\mu$ V	
ADC overload level: Not specified.		Preamp off/on: -8/-17 dBm.		
Blocking gain compression dynamic range: Not specified.		Blocking gain compression dynamic range, 500 Hz bandwidth: <i>20 kHz offset</i> <i>5/2 kHz offset</i> <i>Preamp off/on</i> <i>Preamp off</i>		
		3.5 MHz	123/121 dB 123/120 dB	
		14 MHz	121/118 dB 121/108 dB	
Reciprocal mixing dynamic range: Not specified.		14 MHz, 20/5/2 kHz offset (500 Hz BW): 100/84/84 dB.		
ARRL Lab Two-Tone IMD Testing (500 Hz bandwidth)				
<i>Band/Preamp</i>	<i>Spacing</i>	<i>Measured IMD Level</i>	<i>Measured Input Level</i>	<i>IMD DR</i>
3.5 MHz/off	20 kHz	-131 dBm -97 dBm	-46 dBm -23 dBm	97 dB
14 MHz/off	20 kHz	-132 dBm -97 dBm	-37 dBm -25 dBm	95 dB
14 MHz/on	20 kHz	-138 dBm -97 dBm	-47 dBm -14 dBm	91 dB
14 MHz/off	5 kHz	-132 dBm -97 dBm	-41 dBm -29 dBm	91 dB
14 MHz/off	2 kHz	-132 dBm -97 dBm	-42 dBm -29 dBm	90 dB

found that the power setting is reasonably accurate. It is typically within 1/2 W. At 13.8 V dc input, the required current ranges from about 2 A at 1 W output, to 4 – 4.5 A at full output — much lower than the 8 A maximum current specification. See the *QST* in Depth web page for a table of test results at various

power levels on a number of amateur bands.

Next, I tested the internal automatic antenna tuner (ATU). There is no information given on the ATU's capability, so these tests were run to determine its resistive matching range and loss using a precision

### Manufacturer's Specifications

Second-order intercept point:  
Not specified.

IF/audio response: Not specified.

Receive processing delay time:  
Not specified.

### Measured in the ARRL Lab

Preamp off/on, 14 MHz, +39/+47 dBm;  
21 MHz, +29/+27 dBm.

Range at -6 dB points:\*

CW (500 Hz BW): 495 - 933 Hz;  
Equivalent Rectangular BW: 442 Hz;  
USB (2.4 kHz BW): 266 - 2,750 Hz;  
LSB (2.4 kHz BW): 266 - 2,750 Hz;  
AM (6 kHz BW): 92 - 3,160 Hz.

8 ms.

### Transmitter

RF power output: 20 W (CW/SSB);  
5 W (AM carrier), at 13.8 V dc.

RF power output at minimum specified  
operating voltage: Not specified.

Spurious-signal and harmonic  
suppression: 45 dB.

Third-order intermodulation distortion (IMD)  
products: Not specified.

CW keyer speed range: Not specified.

CW keying characteristics: Not specified.

Transmit-receive turnaround time (PTT  
release to 50% audio output): Not specified.

Receive-transmit turnaround time (TX delay):  
Not specified.

Receive processing delay time: Not specified.

Transmit phase noise: Not specified.

Size (height, width, depth): 2.0 × 5.5 × 9.8 inches (including protrusions).  
Weight, 3.6 pounds.

### Transmitter Dynamic Testing

CW/SSB, typically 1.4 - 19 W;  
AM, 1.4 - 19 W at 13.8 V dc.

At 10.5 V dc: 1.4 - 15.2 W typical.

HF, typically 68 dB; 55 dB (worst case,  
160 meters); 50 MHz, 68 dB.

3rd/5th/7th/9th order, 19 W PEP:  
-32/-46/-50/-58 dB (HF typical)  
-29/-43/-44/-48 dB (worst case, 20 m)  
At 10 W RF output:  
-34/-39/-45/-56 dB (14 MHz)

5.3 to 57 WPM; iambic mode A and B.

See Figures 4 and 5.

S-9 signal, SSB, 400 ms; CW, 132 ms.

SSB, 60 ms.

8 ms.

See Figure 6.

Second-order intercept points were determined using S-5 reference.

\*Default values; bandwidth is adjustable.

setup. The full test results are available on the *QST* in Depth web page. From 160 to 40 meters, the loss was negligible (less than 5%) with high-impedance loads up to 400 Ω (8:1 SWR), but was higher with low-impedance loads. On 20 to 10 meters, loss was negligible with most loads from 5 to 200 Ω and just 12 to 14% at 400 Ω.

I also performed open/short circuit testing. I found no instances where the G90 ATU would match an open or short. This implies that the G90 ATU has reasonably low internal losses — obviously a desirable characteristic.

I did find one obscure problem with the G90's antenna tuner operation. On 17 meters, when some reactive loads were tuned to 1:1 with the internal auto tuner, I observed an unstable transmit power variation between about 12 to 20 W. I first found this when using my 43-foot vertical, but then I was able to duplicate it on the bench. Xiegu reported that they had found this issue with some G90 transceivers, and that the problem is resolved in any units shipped after June 2019. MFJ verified the problem, and also verified that recent G90 transceivers no longer have this issue.

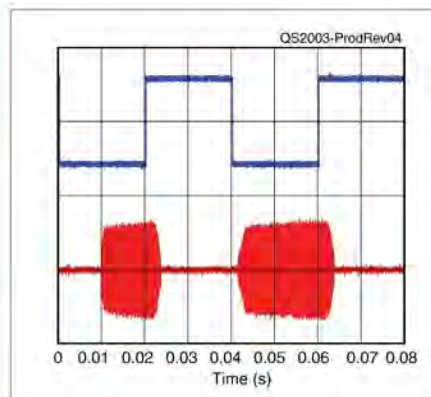

**Figure 4** — CW keying waveform for the Xiegu G90 showing the first two dits using external keying. Equivalent keying speed is 60 WPM. The upper trace is the actual key closure; the lower trace is the RF envelope. (Note that the first key closure starts at the left edge of the figure.) Horizontal divisions are 10 ms. The transceiver was being operated at 19 W output on the 14 MHz band.

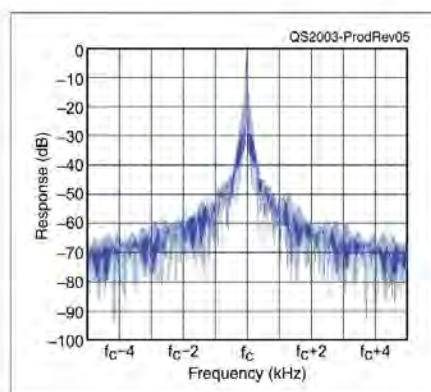

**Figure 5** — Spectral display of the Xiegu G90 transmitter during keying. Equivalent keying speed is 60 WPM using external keying. Spectrum analyzer resolution bandwidth is 10 Hz, and the sweep time is 30 seconds. The transmitter was being operated at 19 W PEP output on the 14 MHz band, and this plot shows the transmitter output ±5 kHz from the carrier. The reference level is 0 dBc, and the vertical scale is in dB.

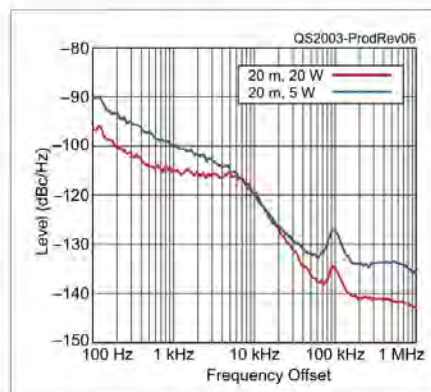

**Figure 6** — Spectral display of the Xiegu G90 transmitter output during phase-noise testing. Power output is 19 W on the 14 MHz band (red trace) and 5 W on the 14 MHz band (blue trace). The carrier, off the left edge of the plot, is not shown. This plot shows phase noise 100 Hz to 1 MHz from the carrier. The reference level is -80 dBc/Hz, and the vertical scale is 10 dB per division.

## Lab Notes: Xiegu G90 HF Transceiver

Bob Allison, ARRL Laboratory Test Engineer

The Xiegu G90 does a fairly good job of handling strong adjacent signals with 108 dB of blocking dynamic range (BDR) at 2 kHz signal spacing. Its two-tone, third-order IMD dynamic range is 90 dB — more than enough for a modest antenna system. Reciprocal mixing dynamic range (RMDR), at 84 dB, is reasonable compared to other portable transceivers we have tested.

The G90 is certainly sensitive when using CW and SSB modes, but it could do a bit better on AM (we like to see 1  $\mu$ V or better AM sensitivity). The second-order intercept point is lower than average, especially at 21 MHz. This means that it's possible to hear unwanted mixing products when propagation conditions are good and shortwave radio signals are strong. For example, two strong broadcast stations transmitting at 6 and 15 MHz may cause a signal generated inside the G90 to appear at 21 MHz. Audio from both broadcast stations are mixed together into one (false) AM signal.

The G90's transmitter exceeds FCC requirements for harmonic and spurious emission levels. Closer to the intended transmitted signal, CW sidebands are higher than average but will not bother stations on nearby frequencies unless signals are strong. Transmit IMD is higher than we would like to see, but is in line with other low-power transceivers we have tested. Transmit phase noise close to the transmitted signal is also higher than we'd like to see. It is for these reasons that we do not recommend using a power amplifier with this transceiver.

## Operating the G90

First, let me state that the display is amazing. As you can see in Figure 3, even though the display is quite small, it is easy to read and provides a tremendous amount of simultaneous information, even showing the signal level in dBm on the spectrum display. I checked the signal level reading against my Elecraft XG3 signal generator, and the G90 displayed levels are quite accurate. The S-meter readings are also quite accurate at reasonable signal levels, dropping 6 dB per S-unit when going from -73 dBm to -107 dBm (S-3 to S-9). The S-meter reads about 20 dB high at a very high -33 dBm signal level (S-9 + 60 dB). Detailed test results are shown in a table on the QST in Depth web page.

While the G90 controls and buttons are self-explanatory when used for typical operation, it is worth mentioning some of the controls that have dual or triple functions. The volume control, when tapped,

redirects the audio from the internal speaker to the headphone jack and reduces the audio level accordingly. Note that the G90 will not directly drive an external speaker. A powered external speaker will be necessary. An AlexMic G90 is available, which has an amplified speaker built into the mic (see [www.alexloop.com](http://www.alexloop.com)). This is very similar to the AlexMic for the KX3 and KX2 reviewed in the February 2018 issue of QST, but with the correct connectors for the G90.

The multifunction knob, located below the power button, defaults to 100 kHz tuning steps for moving quickly around the bands. A long press on this knob brings up other default functions that can be selected instead — squelch level, power output, keying speed, and FFT scale (band scope display gain). The main tuning knob, when tapped, changes the tuning step from 10 to 100 to 1,000 Hz. The five buttons below the display are clearly marked, and their secondary functions (when the **FUNC** button is tapped) are also clearly marked.

To engage the internal auto tuner, tap the **TUNE** button once. Then press and hold **TUNE** to start the tuning process. When tuning is complete, the radio automatically reverts to receive mode. To disengage the tuner, tap **TUNE** again. Tuning normally takes less than 1 second, and the last tuning solution is remembered for each band.

Tapping the **POW** button once permits you to adjust transmit power with the main tuning knob. Tap the **POW** button a second time and you can set the SWR level that will begin folding back transmit power. A long press of the **POW** button enables an SWR sweep. The default scan width is 150 kHz centered around your receive frequency, but you can also select 300, 450, 600, and 750 kHz sweep ranges. One complete scan takes about 5 seconds, and scanning continues until you press **QUIT**. And finally, if you first tap the **FUNC** button and then tap the **POW** button, you can adjust your microphone gain or select the audio input (microphone or external audio).

Tapping the **LOCK** button sequentially adjusts the display brightness. A long press of the **LOCK** button locks the radio, and another long press will unlock it. Pressing **FUNC** and then tapping **LOCK** permits you to adjust the spectrum display gain (FFT level).

## CW Operation

The internal keyer speed range is approximately 5 to 55 WPM. Because I adjust keying speed frequently, I set the multifunction knob default to keying speed. You



can select either CW or CWR (reverse) depending on interference conditions. The default CW filter bandwidth is 500 Hz, but you can narrow this all the way down to 50 Hz by pressing the **FUNC F-L** and **FUNC F-H** buttons.

Break-in delay can be set from 0 to 1 second in 100 millisecond increments. However, the delay will never be less than 100 milliseconds because of the SDR signal processing latency, and so the G90 is not capable of full-break-in (QSK) operation. At this time, there are no CW memories. Unlike the X5105 reviewed in the April 2019 issue of *QST*, I found no evidence of key clicks in the G90. The waveform is shaped well enough to avoid this problem.

Clicking from the transmit/receive relay is audible but not objectionable. In the ARRL Lab, Bob Allison, WB1GCM, noted that there are no rubber feet on the bottom of the G90's case, and mechanical coupling between the transceiver and a hard tabletop surface transfers the sound of the relay to the table, making it louder. Adding rubber feet to the bottom cover will reduce this effect.

### SSB Operation

SSB operation was almost exhilarating for me. While I can easily make CW contacts at the 5 W QRP level, SSB contacts are much more difficult. However, at the 20 W power level, phone contacts are quite easy to make. The G20 includes a speech compressor which is enabled via a button below the display. And while the compression level is currently not adjustable, the fixed setting works very well.

The default SSB receive filter bandwidth is 2.4 kHz, but you can adjust this using the **FUNC F-L** and **F-H** keys as in the CW mode. I found that the default receive audio passband response was very pleasant to listen to. There is currently no transmit audio equalizer, but the transmit audio is excellent according to reports received during contacts on the air.

### Digital Modes

The G90 can be operated with a computer and sound card for FT8, RTTY, PSK, or any of the other popular digital modes. You will need to build or buy an eight-pin mini-DIN radio-to-computer sound card interface cable, or purchase the Xiegu CE-19 Expansion Interface. The interface connections are well documented in the *G90 User Manual*.

### Final Thoughts

I found the G90 to be a very enjoyable transceiver to operate. The 20 W transmitter power makes a very big difference when compared to the typical 5 W QRP transceiver, especially for SSB operation. Because of the SDR architecture, we can expect to see more capabilities and features added over time. My only desire would be to have a built-in tilt stand, and maybe an option to give up 160 meters if 6 meters could be included instead. Finally, the Xiegu G90 has a 2-year warranty when purchased through MFJ Enterprises.

*Manufacturer:* Xiegu Technology Co. Ltd. Distributed and supported in the US by MFJ Enterprises, 300 Industrial Park Rd., Starkville, MS 39759, [www.mfjenterprises.com](http://www.mfjenterprises.com). Price: \$449.95. CE-19 Expansion Interface, \$29.95.

## SOTABEAMS Wolfwave Audio Processor

*Reviewed by Paul Danzer, N1II*  
[n1ii@arrl.net](mailto:n1ii@arrl.net)

The Wolfwave Advanced Audio Processor from SOTABEAMS can add selectivity to an existing receiver or transceiver, and it offers a number of other audio processing features as well. It connects to the headphone jack or speaker output and provides processed audio that can be used with headphones or a speaker.



### Bottom Line

The Wolfwave Advanced Audio Processor offers a number of ways to add filters, noise reduction, and other features to receivers without those amenities.

## Overview

The block diagram for the Wolfwave is simple — audio is fed to an analog-to-digital (A/D) converter, and then it goes to a microprocessor. The processed signal then goes to a digital-to-analog (D/A) converter and then to an audio amplifier connected to the output jacks. The 4 × 3 × 1 inch package is powered by either a USB cable (cable included, without USB power supply) or an external 5.5 to 18 V dc supply. Current draw is approximately 60 mA. We used a 12 V dc wall cube supply.

The Wolfwave is controlled by firmware, which can be updated online using the USB cable. If the USB cable is used to power the unit, the 5 V available in a standard USB connection is fine for headphone use, but it will provide lower speaker output than the 1 W available when using an external power supply of 7 V or more.

The right side panel of the enclosure has a 3.5-millimeter stereo headphone jack and a 3.5-millimeter speaker jack, along with the 2.1-millimeter coaxial dc power receptacle (center pin positive). The left side has the 3.5-millimeter stereo audio input jack and a micro-USB connector. There is also a pushbutton labeled **FIRMWARE** for use during the update process.

One important word of caution — neither side of the speaker can be grounded. The audio amplifier has both output leads floating, and grounding one of them may result in damage to the amplifier. This is important to note if you are using a matching speaker to an older transceiver where one speaker lead is typically grounded to the metal enclosure.

Received audio spectrum and menu commands are shown on a monochrome front-panel display that measures approximately 1½ × 1¼ inches. A two-color LED is mounted just to the upper left of the display and lights green when a CW signal is detected at the center of the passband. There is no power on/off switch, so you will have to control this function externally.

There are three pushbuttons on the front panel. **MENU** picks the general function you want to select or adjust. **MODE** lets you adjust the selected function and access submenus if available. **HELP** brings up context sensitive information, just as a right click does on many PC applications.

On the bottom of the panel are the audio **VOLUME** control and one labeled **MULTI-USE**. **MULTI-USE** helps select operating mode and menu values (more on this control later).

## Using the Controls

I found that there was a bit of a learning curve to be able to rapidly make selections and adjustments using the menus and submenus. The Wolfwave unit has repetitive selection patterns, so with practice, these selections can be made quickly and accurately.

The initial display shows an audio spectrum (100 – 2,700 Hz) with a vertical dotted line in the center representing the filter center frequency. The default is that the band-pass filter is enabled, bandwidth is 2,400 Hz, and the center frequency is 1,500 Hz. To show the general pattern of operation, let's set up a CW filter:

- Rotating **MULTI-USE** (we'll just call it **MULTI**) changes the filter bandwidth in the range of 50 Hz to 5,000 Hz in steps of 10 Hz to 100 Hz depending on bandwidth. You can adjust the width at any time. The display has three ranges, with upper limits of 1,400, 2,700, or 5,000 Hz. It adjusts automatically to the narrowest range that fits the upper edge of the selected passband.
- Press **MULTI** and you will see **CENTRE 1500 Hz** (the default center frequency). Adjust the center frequency by rotating **MULTI** until it matches your preferred CW tone (I like 750 or 800 Hz). Figure 7 shows a 600 Hz filter. You can adjust the filter parameters every time you turn the unit on, store your favorite settings, or select from several preconfigured filters.

To access and adjust other Wolfwave features, the general pattern is:



Figure 7 — The Wolfwave set up for a 600 Hz CW filter with a center frequency of 650 Hz.

- Press **MENU** to bring up a list of functions. Scroll through this menu by rotating the **MULTI** control and then press the **MULTI** control to turn a function on and adjust it. As an example, select **NOISE REDUCTION**, and a press of **MULTI** will turn it on and display a submenu with several options (including an **ADVANCED** submenu with further options).

- Rotate **MULTI** to highlight the desired parameter, press **MULTI** to select the parameter, and again rotate **MULTI** to adjust the setting.

- Within each submenu, highlight the top line and press **MULTI** to go back to the previous menu.

Within the menu system, pressing **MULTI** and pressing **MODE** usually have the same effect. Pressing **MENU** brings you back to the top-level filter display without having to back out through multiple menu layers.

## Testing the Modes and Features

### Bypass Function

A long press of the **HELP** button turns off the processing functions. The label **BYP** will appear in the lower left corner. A second press turns processing back on.

### Band-Pass Filter

On-the-air testing showed the filter was very sharp and as good as I wanted — as long as the LED on the panel showed green. In addition to experimenting with various SSB bandwidths, I tuned in a strong AM broadcast carrier (S-9 plus) to be just inside the filter passband. Then I slowly turned the transceiver VFO knob to move the carrier out of the filter passband. The carrier quickly dropped to just about S-0. With the tiniest change in transceiver tuning I could manage, the carrier switched between these two values — S-9 and annoying, to S-0 and barely audible.

The Wolfwave offers 14 memories to store band-pass filter settings. Four are preset — wide/narrow for CW and data, and wide/narrow for SSB. The rest are open for your selections, and you can designate a default power-on setting.

A recent firmware addition is **BANDSTOP FILTERING**, which allows the user to set up to 10 notches within the passband. The center frequency and width of each notch is adjustable, and the instructions suggest 100 Hz as the minimum usable width. This might be helpful to reduce unwanted signals within the passband, low-frequency hum, high-frequency hiss, or

other irritants. When **BANDSTOP FILTERING** is enabled, any programmed notches are shown in the **BANDSTOP FILTERING** display.

### Noise Reduction and Tone Reduction

I tested the **NOISE REDUCTION** function on 75 meters during July, with typical high summer noise levels. Coarse (5% steps) and fine (1% steps) adjustments are available (see Figure 8). I started with the noise reduction level at 50% while listening to my local club net one evening. That level brought minimal improvement. As I increased the setting toward 90%, the noise went down, but the digital artifacts increased (the underwater effect often heard with noise reduction systems). Weaker stations, which I could not really hear in the noise, were reduced to clipped snippets of sound. However, very strong stations became much more readable. At around 75%, the noise was reduced — but not to zero — and the moderately strong stations were easily understandable. For quieter band conditions, settings around 30% reduce the background noise without too many digital effects.

A submode of **NOISE REDUCTION** is **TONE REDUCTION**, where the Wolfwave automatically identifies and notches a steady tone. The **NOISE REDUCTION** mode must be on for **TONE REDUCTION** to work. I tried this function with AM broadcast carriers ranging from S-2 to well over S-9, and the tone was suppressed effectively. Some fuzziness was introduced when the tone was next to the edge of a sideband signal, but that is to be expected.

### Hearing Loss Correction

The manufacturer describes this function as applying a gain curve that varies with frequency according to the international standard ISO 7029 ([www.iso.org/standard/42916.html](http://www.iso.org/standard/42916.html)). From the main menu, select **HEARING LOSS COMP**, and then your gender and age.

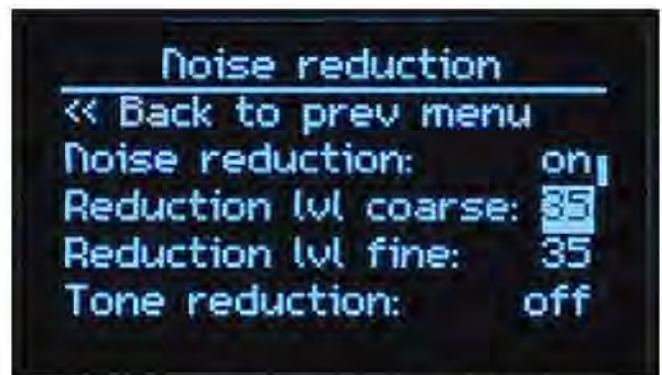

Figure 8 — Setting the Wolfwave noise reduction features.

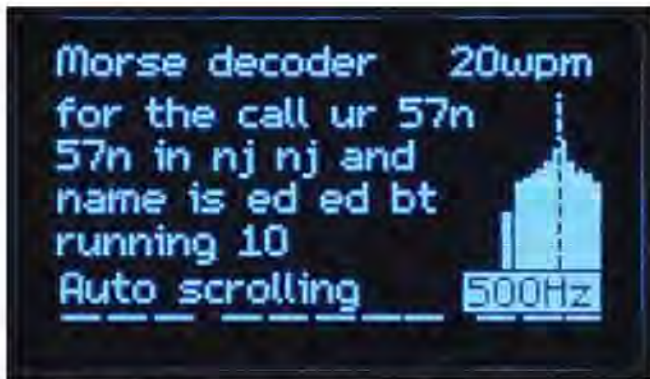

Figure 9 — The Wolfwave Morse decoder screen.

I use hearing aids, so I was very interested in this mode. The instructions also note that if you do use hearing aids, this compensation will not replace the hearing aids. Generally speaking, **HEARING LOSS COMP** adds gain at higher audio frequencies. I removed my hearing aids and set the function for my gender and age. On CW, as expected, I heard no obvious difference because the tone of the CW note was not high (around 800 Hz). Similarly, I didn't hear a noticeable difference while listening on SSB with a filter bandwidth set to 2,300 Hz.

I set the upper limit of the filter bandwidth to 5,000 Hz and tuned in some music on a shortwave broadcast. There was definitely a difference in the high frequencies of the broadcast transmission, but because the bandwidth was limited to 5,000 Hz, I didn't hear a big difference. While this mode appears to work, I didn't find it too useful for typical ham radio modes, which have limited audio bandwidth.

More useful for some operators is the left-right balance control included in a recent firmware update. Accessed from the **OUTPUT SETTINGS** menu, this feature allows increasing the audio level in one ear or the other in ½ dB steps to compensate for differences in hearing.

### Morse Code Decoder

Decoded text appears on the display's left side and an audio spectrum scope on the right (see Figure 9). The received signal to be decoded must be centered in the spectrum scope. You can do that by tuning your receiver to the correct pitch, or by turning the **MULTI** knob to match the Wolfwave to the received pitch.

The Wolfwave automatically adjusts to the received CW speed. The default setting allows CW speeds from 5 to 40 WPM, but you can change the limits from 1 to 100 WPM. The detection threshold can be changed as well, which helps with false decodes from noise.

I found the decoder to be very accepting of off-frequency tuning — the pitch just has to be close to the incoming signal. In addition to showing decoded text, dots and dashes are shown at the bottom of the screen and the measured code speed in words per minute on the top left corner. If the band is noisy, try raising the decoder threshold from its factory setting of 3 dB to perhaps 8 or 10 dB.

### CW Regen

CW regeneration is a function that I have not seen for a long time. Many years ago, the National Company included a function called *Select-O-Jet* in several of its receivers. The circuit gave positive feedback on a selected frequency, and in the presence of noise or other signals, the selected tones would be boosted by the function.

In the Wolfwave, this experimental function detects the dits and dahs in the received signal and regenerates the CW signal with a clean sine wave and no noise. The CW tone to be regenerated must be in the center of the passband, and the trigger level point can be adjusted from 1 to 30 dB. The output (regenerated) tone can be set to be identical to the input CW tone or offset from it. With a stereo headset, you can listen to the received signal in one ear and the regenerated CW tone in the other.

For the regenerator to work, I had to carefully set the band-pass center frequency to the CW tone I use, and to carefully limit the input signal to the green LED range. The CW regenerator works well, but tuning is critical. Any attempt to change the receiver frequency by a tiny amount almost always resulted in loss of copy, requiring shutting the regenerator off and resetting the receive frequency.

### Audio Test Generator

Under **UTILITIES** on the main menu, there is a selection to generate tones. Turning this on brings up an audio generator with the output selections of sine wave, triangle wave, square wave, and two-tone. Each of these can be set to a selected amplitude and frequency.

## Support and Firmware Updates

The Wolfwave package does not include a printed manual, but detailed information about setup and operation may be found on the SOTABEAMS website, as well as a website dedicated to this product ([www.wolfwave.co.uk](http://www.wolfwave.co.uk)). In addition to written instructions, there are tutorials and links to helpful videos.

SOTABEAMS offers accessories and replacement cables for the Wolfwave. One that may be useful is an audio ground loop isolator, which can reduce or eliminate hum from ground loops. This isolator plugs in between your transceiver and the filter, breaking the ground loop.

Firmware updates may be downloaded, along with Windows software and drivers needed for the process. The Wolfwave website offers well-illustrated, step-by-step instructions, as well as a video demonstrating the update process. New firmware with added features was released several times during the review period, so it's a good idea to check periodically for updates.

*Manufacturer:* SOTABEAMS, Macclesfield, United Kingdom; [www.sotabeams.co.uk](http://www.sotabeams.co.uk) or [www.wolfwave.co.uk](http://www.wolfwave.co.uk). Distributed in the US and Canada by DX Engineering, 1200 Southeast Ave., Tallmadge, OH 44278; [www.dxengineering.com](http://www.dxengineering.com). Price: \$275.99.

# Inexpensive Antenna System Tuning Indicators

Reviewed by Paul Danzer, N1II  
[n1ii@arrl.net](mailto:n1ii@arrl.net)

We looked at three inexpensive kits intended to simplify the sometimes-tedious process of adjusting an antenna or antenna tuner for a match that the transmitter can handle. The measuring circuit used in all

three kits is a modified Wheatstone bridge. More information on the circuits may be found on the QST in Depth web page ([www.arrl.org/qst-in-depth](http://www.arrl.org/qst-in-depth)).

**Table 2**  
**Feature Comparison**

	QRP Guys	HecKits	TennaDipper II
3 – 30 MHz range	Y	Y	Y
Counter function	N	Y	N
Signal generator output	N	Y	Y
Prepared case	N	Y	N
9 V battery needed	N	Y	Y
50 Ω test load supplied	N	Y*	Y*
Filter for signal generator	N/A	Y	Y
10 MHz counter time base	N/A	Y	Y

\*The HecKits load is built into a BNC connector. The TennaDipper II includes a 49.9 Ω resistor.

## Bottom Line

All three units reviewed here can help you to adjust an antenna or antenna tuner for minimum SWR by adjusting for minimum brightness on an LED. They are small, light, simple to use, and are well suited for portable operation.

## QRPGuys LED Tuning Indicator

The LED Tuning Indicator from QRPGuys is the simplest and least expensive kit here. Designed to be used with a QRP transmitter (5 W CW or 10 W PEP maximum), this 1½ × 1¼ inch board is placed between the transmitter and antenna tuner or antenna (see Figure 10). The input and output BNC connectors mount directly on the board. Keep transmissions short while using the tuning indicator to find a match, and if possible, reduce power until the antenna or tuner is adjusted to a low SWR.

Construction is straightforward with step-by-step, well-illustrated instructions. The polarity of diode D2 is critical and is shown clearly in the manual. The tuning indicator is designed so that the male BNC connector can mount right on your radio's BNC antenna jack, and the antenna feed line connects to the female BNC jack on the other side. The pin spacing is different for the two connectors, so you cannot interchange them.

A toroidal core is wound as an autotransformer with 25 turns, tapped at 5 turns. An LED shows reflected power — the brighter it lights, the greater the reflected power. The LED and the transformer can be mounted on either side of the board, with the LED facing forward (toward your radio) or on the other side of the board, visible from the back.



**Figure 10** — The QRPGuys LED Tuning Indicator requires no external power source. The input (male) BNC connector is shown here on the component side of the board, with the output BNC connector, indicator LED, and **BYPASS** switch on the other side. The board is intended to mount directly on the antenna jack of the companion QRP transceiver.

The **TUNE/OPERATE** slide switch places the tuning indicator in the feed line path, or bypasses it for operation once tuning is finished. The assembly manual notes that with the switch in the **TUNE** position, the transmitter power is reduced by a factor of four at the output jack (for example, 1.25 W output with a 5 W transmitter). At full LED brilliance, the SWR is 4:1 or greater. The LED goes out at 1:1 SWR, and at half brilliance, the SWR is about 2:1. Note that this device offers no guidance on which way to adjust the antenna system for best match. If the SWR is high, some experimentation is required while watching for the LED to dim.

My 5 W QCX QRP transceiver had more than enough power to light the tuning LED, so it was clearly visible in bright daylight. This radio has the antenna BNC connector on the side of the case and is only 1 5/8 inch high, so the tuning LED could have been mounted on either side of the board and been very visible.

The QRPGuys LED Tuning Indicator is an inexpensive, lightweight, and compact companion for a portable station without an SWR/power meter built into the transceiver or antenna tuner.

*Manufacturer:* QRPGuys, [qrpguys.com](http://qrpguys.com). Price: \$20 plus shipping.

## HeckKits 50 Ω Bridge/Frequency Counter

The HeckKits bridge (see Figure 11) includes a frequency counter and generates a low-level signal from 3 to 30 MHz, so it can be used to adjust an antenna or antenna tuner without transmitting a signal. It's powered from a 9 V battery and fits in a precut 5 1/2 × 2 1/2 × 1 inch plastic box.

The parts to be assembled mount on a single PC board, which is connected to the pre-assembled display module by two ribbon cables (see Figure 12). The builder does not have to solder the ribbon cables to the display board. The boards mount in the case with very small nuts, but a tiny nutdriver is supplied.

Assembly is straightforward. Although I found the written instructions in the assembly manual unclear in spots, the illustrations filled in the gaps. The transistors require bending the center lead away from the flat side to fit the mounting holes. Carefully check the LED to find its polarity. You have to wind a toroid core for the transformer. The winding instructions are very good, but you may want to do the five-turn winding before the 30-turn winding.

I widened the three switch holes in the case with a 5/16-inch drill to provide a bit more clearance for the switches with their caps in place. The on/off slide switch is on the left side. The BNC connector used for the feed line is on the top. The two blue pushbutton switches below the display are used to select the frequency counter or SWR indicator function. Both buttons have to be in the up position for the frequency counter, and both down for the SWR indicator. The LED under the left switch is the SWR indicator.

The black knob on the right side is the shaft of a 30-turn potentiometer to adjust the frequency. According to HeckKits, the small knob shown in Figure 11 has been replaced by a larger, easier-to-use knob in kits that are currently shipping. Frequency coverage is in two segments (3 – 12 MHz and 11 – 30 MHz) and is set by the lower blue pushbutton. The frequency readout is a two-line, eight-digit LCD module. A small variable resistor on the circuit board adjusts the brightness.

To find the resonant frequency of an antenna system, connect the feed line to the BNC jack. Set the device to bridge mode and adjust the potentiometer until the LED extinguishes. At that point, the SWR is 1:1 and the frequency is shown on the display. Alternatively, set the HeckKits bridge to the desired frequency and adjust the antenna or tuner until the LED goes out. The kit includes a 50 Ω dummy load mounted in a

BNC connector to make testing the bridge and understanding operation easier.

By noting an antenna's resonant frequency on the display, you can try lengthening the antenna if it is resonant higher than the desired frequency, or shorten the antenna if it is resonant below the desired frequency. Adjusting an antenna tuner will require some experimentation.

To use the device as a frequency counter, set both blue pushbuttons to the up position and connect the signal to be measured to the BNC jack. Be careful to keep the applied signal to less than 100 mV.



**Figure 11** — The HeckKits 50  $\Omega$  Bridge/Frequency Counter is mounted in a plastic case with a two-line by eight-character LCD.

**Figure 12** — The builder assembles the main HeckKits PC board (on the left) and then connects it to the pre-assembled display board with two ribbon cables.



The test signal generated for the SWR indicator is a square wave that goes through a minimal filter. The output is not a single-frequency signal, but has harmonic components — generally odd harmonics for a square wave. While trying to find the resonant points of a triband Yagi, I found a number of resonances outside the ham bands. Some of these may have been due to the harmonics from the signal generator. Although it's not discussed in the manual, this device can be also used as a simple signal generator to see if a receiver is working.

*Manufacturer:* HeckKits, 1302 Highland Dr., Cedar Park, TX 78613; [heckkits.com](http://heckkits.com). Price: \$85, plus \$7.90 shipping.

### Pacific Antenna TennaDipper II

The TennaDipper II is similar to the HeckKits unit, but it uses an LED rather than LCD frequency display (see Figure 13). The case measures approximately  $4\frac{1}{2} \times 2\frac{3}{4} \times 1$  inches. The four-digit frequency display shows through a window on the front panel, and like the other two units, the **MATCH** LED goes out when the connected load is close to 50  $\Omega$  (1:1 SWR).

For construction, you will need a pair of tweezers. A surface-mount IC is used as the voltage regulator. The simple instructions for mounting it are quite clear, but you will want to use something other than your finger to hold it in place while soldering.

All parts mount on a single PC board (see Figure 14).

The board is very well made, with an excellent solder mask to prevent solder bridges. The pushbutton switches, **POWER** and **RANGE**, are not square. If a switch does not fit easily, rotate it 90 degrees. As with the HeckKits unit, you will need to wind a toroid core for the transformer. I wound the five-turn segment first, leaving the rest of the toroid for the 30 turns. To make sure that the **MATCH** LED can be seen through the hole in the front panel, it must be raised off the board before soldering.

The kit includes a blank plastic enclosure and front-panel decal, but the builder needs to make the holes for the switches, BNC connector, and display. The PDF with the manual devotes six pages to the case preparation, including a page with a 1:1 template for the cutouts.



**Figure 13** — The TennaDipper II in its plastic case. The controls are nicely labeled with a decal that covers the whole front panel. The builder needs to carefully cut and drill the case for the display and controls, as described in the text.

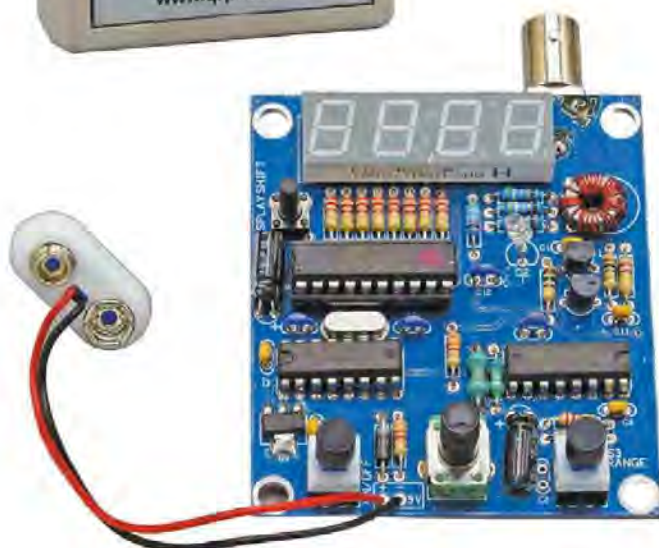

**Figure 14** — The completed TennaDipper II board before mounting in the case. All components are mounted on the board, and the controls and display must carefully line up with cutouts in the case.

Before drilling the case, check the printed template carefully to make sure it is the correct size. The manual recommends using a step drill bit, and that worked well. You have to drill it perfectly to use the hole sizes shown on the template. I ended up making the holes one step larger than specified to get the buttons to operate smoothly.

More difficult was getting a good clean cut in the front panel decal, even with a Mazor knife with a fresh blade. The instructions recommend using a hole punch for best results.

Operation is similar to the HeckKits unit, except the TennaDipper II does not function as a frequency counter. Connect the antenna or antenna tuner to the

BNC connector. Frequency is controlled by the single-turn **TUNE** knob. The **RANGE** switch toggles between 3 – 11 MHz and 10 – 30 MHz. Pressing the **DISPLAY SHIFT** switch changes the display from frequency in MHz with 10 kHz resolution to frequency in kHz with 100 Hz resolution. The **MATCH** LED brightness dips as the SWR goes down, and it is very dim or completely out when the SWR is 1:1.

You can see whether to lengthen or shorten an antenna by noting its resonant frequency on the display. With an antenna tuner, you will need to experiment with different settings to find a good match.

As with the HeckKits unit, you can use the TennaDipper II as a simple signal generator. The square wave output is somewhat rounded by two single-stage L filters, but the output does have harmonics.

Excepting for my difficulty preparing the case, I found the instructions and illustrations very clear, and the result is a very nicely designed and packaged instrument.

*Manufacturer:* Pacific Antenna, P.O. Box 10301, Fayetteville, AR 72703; [www.qrpkits.com](http://www.qrpkits.com). Price: \$45 plus shipping.

Explore the *QST* Product Review Archive  
[www.arrl.org/qst-product-review-and-short-takes-columns](http://www.arrl.org/qst-product-review-and-short-takes-columns)  
 Search reviews by year or issue of publication, or by manufacturer's name.

## New Products

### SOTABEAMS 2-Meter Band-Pass Filter

Designed and manufactured by SOTABEAMS, this band-pass filter is intended for use with handheld transceivers in areas with multiple transmitters, such as during hilltop or mountaintop operations. The filter offers SMA female connectors at both ends and is rated for 5 W at a 30% duty cycle and 2 W continuous. The filter bandwidth is 144 to 148 MHz with attenuation of up to 70 dB outside of the passband. \$49.95; [www.sotabeams.co.uk](http://www.sotabeams.co.uk).





## The Doctor is In

# A Satellite Antenna System Doesn't Need to Be Complicated

**Q** Allen, KF4JTR, asks: I want to build an antenna with a pattern pointed straight up to install at my house for use with satellites. I'm hoping to have a 160° view of the sky to get about 75% of the satellite's flight path while it's at its closest. I currently have a dual-band vertical with two obvious lobes — one just below 20° and the other at about 40°. The lobe at 40° works well (likely due to the satellite's distance plus the gain of the lobe), but makes it difficult to make a contact because of signal loss as the satellite passes in and out of my antenna's pattern. Suggestions would be appreciated.

**A** I think classic antenna guru L.B. Cebik, W4RNL, (SK) designed exactly the antenna you want in his article, "A Simple Fixed Antenna for VHF/UHF Satellite Work," from the August 2001 issue of *QST*.

This antenna consists of a pair of Moxon compact Yagis pointed skyward and driven 90° out of phase for an omnidirectional azimuth pattern for both 2 meters and 70 centimeters (it could be built for just one band if that's your only requirement). Figure 1 shows the configuration and the article discusses why it's superior to the more frequently encountered turnstile-connected dipoles over a reflecting screen.

As you get more involved in this, you may want to set up a V/UHF SSB station, if you don't have one already. If so, you will likely want to have Yagis for 2-meter and 70-centimeter SSB, CW, and digital modes. These will



Figure 1 — L.B. Cebik's, W4RNL, dual-Moxon phased array antennas for 2-meter and 70-centimeter satellite work.

probably be horizontal rotatable antennas.

I mention this because in the late 1970s, I used horizontal Yagis in a brief encounter with amateur satellite operations. While many think that an azimuth-elevation rotator is needed to make a successful Yagi-based satellite antenna system, in my experience that's not the case (at least for satellites in low orbits). Horizontal gain antennas pointed toward the horizon at the proper azimuth as the satellite clears give you the highest gain at maximum range where needed. As the satellite goes overhead, the range is closer, and the Yagi needs little or no gain to maintain communication. With horizontally polarized Yagis for 2 meters and 70 centimeters, your antennas are also set up for terrestrial SSB and CW operation, which can be great fun, especially during V/UHF contests.

**Q** Barrie, VK2IBE, asks: I'm at a farm 60 miles south of my home in Sydney, Australia, where I've hosted amateur radio HF SSB and CW DX contests with plenty of space and a very low noise floor. We have no power lines here — we run on solar electricity from batteries and an inverter — and our nearest neighbor is about a mile away. We have been disappointed that despite having 500 W amplifiers (run at our legal limit of 400 W) on our three transceivers, we still often hear stations calling "CQ contest" that can't hear us. We assume it's a problem with our transmission lines or antenna systems, which we plan to assess (perhaps using *WSPR*). We'll also try raising and reorienting our horizontal dipole antennas and shifting to lower-loss coax. Do you have any other recommendations to improve our performance?

**A** Having a low noise floor offers a great advantage on receiving, however, the stations you hear so well may have a noise floor of S-4 to S-6, since they probably aren't as well situated as you are. Also, those calling CQ are often strong stations — they generally need to be strong to hold a frequency.

They are likely running the legal limit of 1,500 W PEP (6.7 dB over 400 W, more than 1 S-unit) output in the US, and running three- or four-element Yagis (perhaps 4 dBd, and a pair stacked, for the serious contest stations, another 3 dB).

Given that, they are transmitting with 11 – 14 dB, or around 2 S-units higher than you are. If they have an S-4 background noise (along with likely more local interference than you), it suggests that if all things are equal, you will need to hear them with an S-meter reading of 2 – 3 S-units higher than your background/receiver noise level to be about even in their receiver. The good news is that you can hear better than they can, but the bad news is that you need to transmit a stronger signal to overcome their noise and have a similar signal at their station.

Some of this is reasonably simple to improve on. Perhaps the easiest way is power level. Where I am, on most bands the power limit is specified as the transmitter output, but in some cases it is or has been specified as power transmitted by the antenna. If your rules are specified as power transmitted by the antenna, rather than out of the transmitter, you may be able to crank up your amplifier to 500 W for a 1 dB improvement (in a contest, every little bit helps).

You don't say how long your transmission lines are, or what type you

are using. Long lossy runs make high SWR look low at the radio, meaning the line loss may be higher than you expect, based on your measurements at the radio. Having an antenna tuner at the radio will tend to mask this even more.

If your lines are longer than 50 feet, it's best to measure and record the SWR close to the antenna and determine the loss in the line based on that reading. If that's difficult, you can calculate the actual SWR at the antenna from the measurement at the radio using *TLW* (*Transmission Line for Windows*) software. For more information, see my article, "I Know What's Happening at the Shack — What's Happening at the Other End of my Feed Line?" from the February 2007 issue of *QST*.

If the real SWR is much higher than indicated at the radio end of the coax, you may have more loss than you think, and *TLW* will tell you the whole story. That's power that you don't need to waste.

That leaves antennas. If you have trees in appropriate places, or are willing to install masts, rhombics are a good solution at relatively low cost, especially if you're interested in a few directions. A single rhombic can cover 20 through 10 meters, or any other 2:1 frequency range with good performance. The use of a triplexer with filters can allow multi-transmitter stations to share a single multiband antenna on 20, 15, and 10 meters, for example, simultaneously. A Yagi at a good height can also do very well and offers more flexibility, but will likely cost more.

Or, keep in mind that you can only expect to work strong stations if they will have a high signal-to-noise ratio (SNR) at your end.

**Q** Joe, W3TTT, asks: I use 50 feet of coax cable for a 30-foot run from my multiband vertical to the antenna tuner, with the remaining length coiled in the shack. Does the inductance of this coil of 10 turns at a diameter of about 8 inches have an effect on my signal?

**A** No, the inductance of the coil does not reduce your signal. Your signal should be between the outside surface of the coax inner conductor and the inside surface of the shield. This is called a differential-mode signal. The inductance of the coil only applies to signals on the outside of the shield, where you don't want any signals. Such signals are called common-mode current and can cause problems if they make it to your equipment. The coil will be helpful in attenuating the common-mode current. It's even better to do the choking outside, to minimize coupling the common-mode signals into and from household appliances.

The extra coax will add some loss to your antenna system. Your multi-band vertical, if properly tuned, should have a low SWR on all its designed bands, so the loss should not be an issue. If you use RG-58 coax, with a 1:1 SWR, the loss in the 20 feet is about 0.6 dB at 30 MHz, and 0.24 dB if you're using RG-213 coax. At 14 MHz, it's 0.38 dB for RG-58 coax, and 0.15 dB for RG-213. While this is avoidable loss, it doesn't amount to much. Keep in mind that it takes 6 dB for a single S-unit on a calibrated receiver.

Do you have a question? Ask the Doctor! Send your questions to "The Doctor," ARRL, 225 Main St., Newington, CT 06111, or email your question to: [doctor@arrl.org](mailto:doctor@arrl.org).

Also listen to the archives of episodes of the *ARRL The Doctor* in podcast, sponsored by DX Engineering, on iTunes, Blubrry, Stitcher, or on the ARRL website at [www.arrl.org/doctor](http://www.arrl.org/doctor).



[www.dxengineering.com](http://www.dxengineering.com)

## Hints & Hacks

# Testing LEDs, Mic Matters, Cleaning Connectors, and More

### Testing LEDs Fast

Over the years, I've amassed about 1,000 LEDs from many sources, in all different colors and sizes. In the past, I tested them with a 12 V dc power supply, dropping resistor, and a few clip leads, which was a hassle.

I discovered a simpler, more convenient way to test them. All it takes is one quarter-sized, very thin, 3.6 V battery. I just slide the battery between the LED leads and the LED will either light up or it won't, indicating a bad LED or the need to flip the LED to the other polarity (see Figure 1). The speed and ease of this method has helped me test many LEDs without the need for a power supply, resistors, or clip leads. — *William Gerhold, K2WH, k2wh@optonline.net*

### Mic Audio Solution

After years of trouble-free operation, one day my Kenwood MC-60A desk microphone wouldn't put out audio on my Kenwood TS-790E transceiver.

The PTT switching worked perfectly, but there was no sound. It happened often when starting a transmission.

I experienced this problem on all combinations, between different transceivers and mics. A few other Kenwood users reported the same issues. Most of them were also heavy users and used the same sets. I did some more testing but could not find anything consistent.

Finally, I bought a new curled mic cable and immediately noticed the difference. I had no trouble at all. When I examined the new cable, I noticed the tight fitting of the cable plug.

This inspired me to work on my old curled cable plugs to improve the fitting. When I tried them out, I had no issues. Apparently, the spring-force of the female contacts in the cable plugs of the mic cable lose strength when used frequently. This leads to loss of audio during transmitting.

Bending the female contacts back to improve contact force helped only temporarily, so if you're experiencing this issue, a new plug is the real solution. — *Frank Laanen, PE1EWR, pe1ewr@zeelandnet.nl*

### Anti-Fly Hamfest Fliers

Have you ever placed your club's hamfest fliers on a table at a prior hamfest to promote your event, only to later find that your fliers have fallen onto the floor? At the Skyview Amateur Radio Society, we have eliminated

this issue by binding our fliers into handy tear-off tablets.

Organize a batch of fliers into a neat stack and place them at the edge of a table. Then place something heavy (such as a power supply) at the top edge of the stack. Apply Elmer's glue with a small brush (or even your finger), coating the edge of the stack, as shown in Figure 2. Come back in a few hours and — *presto!* — you now have a tablet that will hold all the fliers in place until interested visitors pull them off. — *Bob Bastone, WC3O, wc3o@arrl.net*

### Oil Burner Woes

I've operated SSB for years on the HF bands without interfering with our household electronics, but when I started using FT8 — a 100% duty cycle mode — my average output power was much higher. As a result, each time I transmitted, our oil burner would immediately shut down.



**Figure 1** — Sliding a 3.6 V battery between the leads of an LED provides an easy method to test whether the LEDs are working. [William Gerhold, K2WH, photo]



**Figure 2** — Assemble a stack of fliers and align them at the edge of a table, using a heavy weight (a power supply in this example) to compress the paper and hold it in place. Using your finger, apply Elmer's glue along the entire edge of the stack. Allow to dry completely. [Bob Bastone, WC3O, photo]



**Figure 3** — Winding about 14 turns of the thermostat line through a Type-43 ferrite core kept RF out of this oil burner control. [Dan Bowman, K1FEV, photo]

After some trial and error, I found the RF was getting into the burner control through the wire from the thermostat. Fortunately, the solution was straightforward. I purchased a Type-43 ferrite core and wound about 14 turns of the thermostat line through the core (see Figure 3). Problem solved! — *Dan Bowman, K1FEV, k1fev@arri.net*

### Clean that Connector!

DB9s and similar connectors can become intermittent due to the buildup of dirt and oxidization on the socket surfaces. An inexpensive and effective way to clean the sockets without having to remove the connector is to use a standard interdental cleaner with a tapered flexible wire brush (see Figure 4). These interdental brushes can be found at most drug stores.



**Figure 4** — Sockets on small connectors, like the DB9 shown here, can be cleared of dirt and contaminants with an interdental brush. [Henry Boze, N4HB, photo]

To clean the contacts, add a small amount of electrical tuner cleaner or other suitable electronic cleaning solvent to the brush and clean out the plugs as required. The brush fibers should be periodically cleaned with a cloth or paper towel to remove any contamination. This process works well and has saved many female-type plugs, particularly those that are used in damp environments. — *Henry Boze, N4HB, henry.boze@gmail.com*

### Yaesu MH-36B6JS Microphone Repair

I have a Yaesu FT-100 mobile radio. Recently, I had an issue with the coiled cable breaking at the strain-relief, so I bought and installed a replacement.

Everything worked fine until the push-to-talk (PTT) started acting up. It seemed as though I had to click the PTT several times (with the radio off, of course) in order to make the switch work. Then it would work intermittently, not engage at all, or disengage toward the end of a transmission. If I wiggled the PTT button, pushed it to one side while transmitting, or simply mashed it, it would work for a bit, but then become intermittent again.

Rather than buying a replacement microphone, I decided to take a homebrew approach. I found a great deal on microswitches on Amazon —

a bag of 20 for just \$7. These switches have side terminals where the original in the microphone had end terminals. This was not an issue because the terminals sit way above any surface-mount component.

The two bottom terminals are NO (normally open) terminals that close when the switch is activated. The top terminal is an NC (normally closed) terminal that opens when the switch is pressed. I trimmed the NC terminal off the new switch and soldered two new wires to the remaining terminals. I took the mounting screw out of the original switch and de-soldered the connecting wires from the printed circuit board.

Next, I soldered the wires from the new switch to the board. I then positioned the new switch over the mounting hole and screwed it in place. The original switch had a locator pin that kept it from rotating on the circuit board. The new switch does not, but it doesn't try to rotate when activating the PTT. Also, the end of the switch rests against one of the channel up/down switches, which gives it more support.

After re-installing the mic button, I re-assembled the mic and tested it during our weekly RACES/SKYWARN net. It works flawlessly. The microphone is back to "original" condition with a new cable and a new PTT switch, all for much less cost than expected. — *Doug Birky, KB8M, kb8m@arri.net*

"Hints and Hacks" items have not been tested by QST or ARRL unless otherwise stated. Although we can't guarantee that a given hint will work for your situation, we make every effort to screen out harmful information. Send technical questions directly to the hint's author.

QST invites you to share your hints with fellow hams. Send them to "Attn: Hints and Hacks" at ARRL Headquarters, 225 Main St., Newington, CT 06111, or via email to [hh@arri.org](mailto:hh@arri.org). Please include your name, call sign, complete mailing address, daytime telephone number, and email address on all correspondence. Whether you are praising or criticizing an item, please send the author(s) a copy of your comments.

## Eclectic Technology

# Inexpensive Remote Operation with *NoMachine* and a Raspberry Pi

Harry Bloomberg, W3YJ, has come up with an easy, affordable approach to remote operating that will allow you to operate your station from almost anywhere. You can contact Harry at [w3yj@arrl.net](mailto:w3yj@arrl.net). — Steve Ford, WB8IMY

The first piece of my cost-effective remote solution is the Raspberry Pi. The Pi is a small single-board computer. It can run a popular distribution of the Linux operating system known as *Raspbian*. Raspberry Pis are inexpensive, starting at \$35. A Raspberry Pi 4 with 4 GB of RAM can be purchased as a complete package with accessories for \$99.

The next piece is *Fldigi* and *Flrig*, part of the Narrow Band Emergency Messaging Software (NBEMS) suite developed by Dave Freese, W1HKJ. Most hams associate NBEMS with emergency and public service operations. It is the standard communications package for many ARES groups. However, NBEMS also provides many features for recreational opera-

tion. *Fldigi* can function as a contest logger and CW keyer, for example. *Flrig* allows you to control a transceiver through a USB interface.

The final piece is *NoMachine* remote operating software. *NoMachine* is popular in the business world and uses the NX protocol to connect securely. *NoMachine* is free for personal use and will stream audio to and from the Raspberry Pi after running a few Linux commands. This gives you the ability to operate CW and SSB.

*NoMachine* makes clients for all major platforms including Windows, MacOS, iOS, and Android that can connect to the *NoMachine* server on the Raspberry Pi. *NoMachine* for all platforms along with installation instructions, documentation, and support is available from [www.nomachine.com](http://www.nomachine.com).

### Putting It All Together

You can use a Raspberry Pi 3 in your remote station, but experience has

shown that a Raspberry Pi 4 is more stable due to its improved CPU performance (see Figure 1).

Audio is processed on the Raspberry Pi by a package named *PulseAudio*, which acts as an audio server, sending and receiving streams of audio much as a web server sends and receives internet data. *NoMachine* interfaces to *PulseAudio*. A common commercial use for *NoMachine* is logging onto remote systems and streaming audio remotely to remote mics and speakers for Voice over Internet Protocol (VoIP) communications.

A detailed explanation of how to interface *NoMachine* with *PulseAudio* is beyond the scope of an article for *QST*. Please see the *NoMachine* remote operation overview and tech notes online at [www.w1hkj.com/W3YJ/Remote\\_Article.pdf](http://www.w1hkj.com/W3YJ/Remote_Article.pdf) and [www.w1hkj.com/W3YJ/Remote\\_Tech\\_Notes.pdf](http://www.w1hkj.com/W3YJ/Remote_Tech_Notes.pdf).

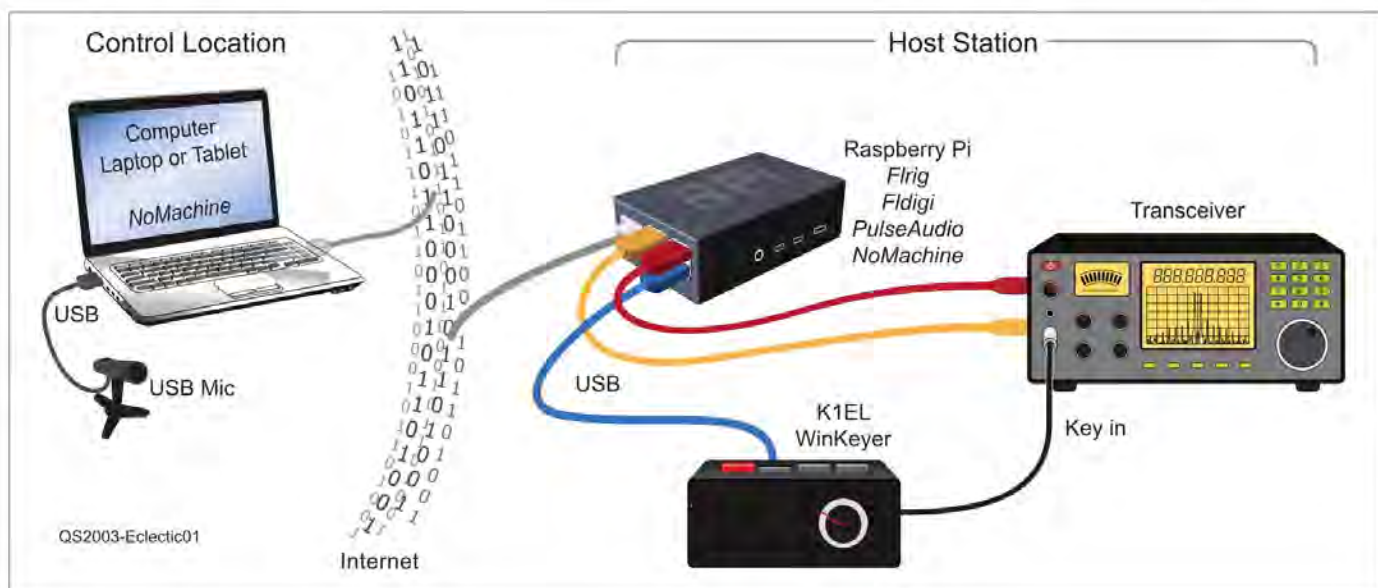

Figure 1 — A block diagram of Harry's remote station control system.

# A Grid DXpedition in the Upper Peninsula

A recently licensed ham organizes  
an activation of a remote grid  
square in Michigan.





The K8B team, from left to right: Dan Brandner, N9DJB; Matt Okeson-Harlow, NM9O; Barry Arneson, K8SD; Thomas Baden, AC9BJ, and Troy Faulkner, KB9AZZ.

Sunset on Friday night after setup. Troy, KB9AZZ, is at the base of the mast, with visitors viewing on left.

## Dan Brandner, N9DJB

As a new radio amateur, first licensed in August 2017, I always thought that large DXpeditions were too expensive and not feasible for the average ham, so I was searching for something closer to home, and at a reasonable cost. I was excited when I heard about the 2018 ARRL International Grid Chase, an event encouraging hams to activate rare or remote Maidenhead grid squares all over the world.

## Making the Plan

After looking for a grid to activate, I decided on an expedition to EN67 — a grid square just 6 hours from my home and almost entirely over water, except for the tip of the Keweenaw Peninsula in the Upper Peninsula, just outside of Copper Harbor, Michigan. Operation could take place atop Brockway Mountain, a pull-off loop at the high point of Brockway Mountain Drive that follows the backbone of the Keweenaw Peninsula. I pitched the idea to my friend and mentor, Troy Faulkner, KB9AZZ, who agreed to be a part of the adventure. Thus, the planning began.

From researching online, we discovered that the location and grid is occasionally activated by intrepid hams, such as a group led by Tim Rush, N8DUY, who activated EN67 in 2015 as K8N. We contacted Rush for advice, who informed us that we needed special permission and a signed agreement from the local township to stay overnight. He also said that we needed to plan for the possibility of high winds on the exposed ridge and rocky soil that wouldn't be conducive to staking ground rods or guy lines.

We obtained the necessary agreement and permits after picking our operating dates — the weekend after Labor Day 2018. To make this an official expedition, we acquired the special event call sign K8B for the activation and set up accounts for K8B on Logbook of The World and **QRZ.com**. To promote our activation, we contacted *QST* to get the event on the magazine’s calendar and posted to two Facebook groups related to the ARRL Grid Chase.

### Setting Up

I’m a relatively new ham, but fortunately, Troy and the other operators have years of experience and piles of equipment to select from. The transceivers we decided to use were the Icom IC 7300, Kenwood TR-751A, Yaesu FT-857D, Yaesu VX-1R handheld, Yaesu FT-847, and Yaesu FT-625RD.

For antennas, we used an end-fed half-wave antenna supported on painter poles for 80 to 10 meters; a Hustler 5BTV for 80, 40, 20, 15, and 10 meters; a Collins Radio AS-2259/GR military antenna; a 35-foot guyed portable mast with a drive-on plate for inverted v’s and raising the ends of long wires; a homebrewed KG0ZZ 40/80-meter inverted-V dipole; a four-element 6-meter beam; a 14-element 2-meter Hy-Gain/Telex 214B-S beam; a horizontally or vertically switchable polarized 70-centimeter beam, and a horizontal 80-meter delta loop thrown together for this activation. Along the way, we made a low-cost 35-foot mast and drive-on mast plate. We also had to factor in extra rope for guying options, extra stakes for shallow soil, and the grounding grid.

Troy served as our technical support in erecting antennas and grounding systems. He also invited other ham friends who could help activate the VHF and UHF bands. Matt Okeson-Harlow, NM9O, provided IT, network, and logging capabilities.

**Table 1**  
**K8B EN67 Grid Activation — QSO Counts**

Band	CW	SSB/FM	FT8	Totals
70 centimeters		8		8
2 meters	10	13		23
6 meters		2	40	42
17 meters			8	8
20 meters	1		201	202
30 meters	3		19	22
40 meters	2	21	332	355
80 meters		8	18	26
<b>Totals</b>	<b>16</b>	<b>52</b>	<b>618</b>	<b>686</b>



The operating station for the VHF/UHF team. From left to right, Troy, KB9AZZ; Barry, K8SD, and Thomas, AC9BJ.



## Contacts Near and Far

By 4 PM Friday, we had the primary antennas up and were operating. We tried several different modes and bands, but a lot of our contacts were on FT8, as band conditions were not favorable. Days were beautiful and sunny with light winds (as we were warned), but it was nothing our setup couldn't handle.

I converted my 2004 Honda Odyssey van into a mobile operating station for the trip. With the antennas, generators, and fuel deployed outside the van, I had room to sleep alongside my clothes, food, and water supply. The other operators worked out of a trailer converted into an operating station and slept in their vehicles or headed back into town for the night. Despite band conditions, we had a lot of fun.

Visitors stopped by throughout the weekend and the sign we were required to post, per our agreement with the town, was useful in explaining our activity. Occasionally, a ham stopped by with a mobile

2-meter rig, Troy would use a handheld transceiver to make a contact, and we'd add them to the log.

We made 686 contacts (see Table 1) and, by the Wednesday after the event weekend, we were already receiving QSL cards in the mail. For a relatively new ham, this portable operation made for a more manageable and exciting "DXpedition" experience. By all measures, my team and I deemed it a success.

Photos by the author.

As a teen, Dan Brandner, N9DJB, was interested in everything science related, including electricity, magnetism, and electronics, and he followed that passion into obtaining a degree in chemistry and computer science. In August 2017, he passed both his Technician and General licensing tests in one day.

In January 2018, he retired from his career at Land O'Lakes, Inc., and was able to focus more on ham radio activities, particularly building and fabricating. He built the 35-foot mobile mast used in the 2018 ARRL Grid Chase, as well as the "Coil-Loaded 40/80 Meter Inverted V Dipole Antenna" project from Zed Zed's Workbench, which was used with that mast.

Dan Brandner's, N9DJB, operating position in his van.



For updates to this article, see the **QST Feedback page** at [www.arrl.org/feedback](http://www.arrl.org/feedback).

**VOTE**

If you enjoyed this article, cast your vote at [www.arrl.org/cover-plaque-poll](http://www.arrl.org/cover-plaque-poll)



Erection of the 35-foot mast with drive-on plate and multiple guy ropes. On the side of the van is the banner created per the sign posting agreement, declaring the team's amateur radio activation of EN67 and the hours of operation.

# How the Ionosphere Was Confirmed

A timeline of the tools and methods used to confirm the existence and height of the ionosphere.



## Robert H. Welsh, N3RW

From the beginning of the 20th century to the 1930s, physics experienced a revolution with a new understanding of quantum mechanics. Long-wave radio broadcasting grew, with new scientific studies following. Further investigation of the effects of high-energy, subatomic particle collisions with high-voltage pulse generators led to the development of new wavelength theories, such as the Austin-Cohen equation, which states that, as wavelength decreases, radio waves travel over longer distances. Given this hypothesis, the shorter wavelengths were considered useless for long-distance radio communications, and were relegated to radio amateurs, who found great success transmitting reliably over long distances.

Understanding the evolution of the methods used to study ionospheric conditions can determine success for DX chasing and shortwave listening today.

## December 1901

Guglielmo Marconi received a transatlantic radio signal from Cornwall, England, to Newfoundland, Canada. From this trial, the concept of radio waves traveling over long distances was introduced.

## 1902

Arthur Edwin Kennelly of the US and Oliver Heaviside of England hypothesized the existence of a conducting layer in the upper reaches of Earth's atmosphere.

## 1909 – 1917

A.H. Taylor, a physicist and professor at the University of North Dakota, experimented with radio waves and investigated the relation between weather and received signal strength.

## 1912

A federal law was enacted to restrict amateurs to frequencies above 1,500 kHz — a government policy that greatly extended shortwave experimentation.

## 1912 – 1914

Dr. Lee de Forest and Dr. Leonard F. Miller at the Federal Telegraph Company made the first crude measurements of the Kennelly-Heaviside layer height using a spark transmitter that delivered 1,200 kW to an antenna at currents approaching 750 A. The wavelength of the transmitter was 3,260 meters (a frequency of 92 kHz). De Forest called this "apparent selective absorption" and hypothesized that the main wave was returned by a reflecting layer whose heights were 17, 27, and 37 miles above Earth. Pierce calculated the reflecting layer's height to be 192 miles.

## 1918 – 1923

William F.G. Swann studied the conductivity of the upper atmosphere at the University of Minnesota. Swann suggested an experiment to measure the distance of the conducting layer by measuring the time taken by wireless waves to reach that layer and return. Unfortunately, Swann's experimental procedure failed as the receiver was not fully blanked during the transmitted pulse.

## 1924

Albert Hoyt Taylor and his colleagues at NRL, in cooperation with John L. Reinartz, 1XAM/1QP, of the ARRL, and other radio amateurs discovered *skip distances* in which high-frequency radio waves could be transmitted to a distant receiver, while being imperceptible at many points in between.

Gregory Breit, a mathematical physicist in the Department of Terrestrial Magnetism (DTM) at the Carnegie Institution of Washington, and Merle Tuve, a PhD candidate at Johns Hopkins, investigated the conducting layer, attempting an experiment using a parabolic reflector and transmitted in the 90 MHz range to measure the height of the reflecting layer. The reflector was never built, which is fortunate in retrospect, because a 90 MHz signal would not be reflected back by the ionosphere, except under sporadic-E layer reflections. Further attempts were at much lower frequencies owing to Breit's cooperative efforts from stations in New Jersey and Massachusetts.

The best results were received from the NRL transmitter, which was one of the earliest crystal-controlled transmitters in use. Breit and Tuve used the new technique of oscillograph recording to analyze the received pulses.

The E-layer is the lower part of the ionized layer at an altitude of between 56 kilometers to 104 kilometers (35 miles to 65 miles) above the Earth's surface. The upper layer — divided into two layers (F1 and F2) — exists almost all the time, whereas the E-layer comes and goes depending on solar activity.

## July 28, 1925

Breit and Tuve received the first conclusive results of ionospheric reflection at a frequency of 4.2 MHz from a 10 kW transmitter sending 200-microsecond pulses. Their results showed that the height of the reflecting layer varied from day to night. Their calculations indicated that the height ranged from 55 miles during the day, but it rose to 130 miles at night. They were not yet aware that the layers varied as a result

of solar ultraviolet and X-ray emissions, which did not excite the atmosphere when the sun was not visible. Today, users of the HF spectrum recognize that there are several layers at different heights: D at about 30 miles, E at about 60 miles, and F<sub>1</sub> and F<sub>2</sub> at heights around 180 miles.

*To measure the ionosphere's height, Breit and Tuve followed the following procedure:*

- 1) Use directional loop antennas for receiving.
- 2) Record the received pulses from both the sky-wave signal and ground-wave signal.
- 3) Apply the time difference between the sky-wave signal and the ground-wave signal.
- 4) From the difference, use their derived equation to measure the layer height.
- 5) Use a derivation of the Pythagorean theorem to compare the time for the sky wave and the ground wave to reach the receiver. From the difference in the two arrival times, Breit and Tuve calculated the height of the reflecting layer to be about 80 miles.

## 1945 – 1990

During the Cold War, high-frequency radio systems were still in wide use by many military organizations around the world. Using oblique sounders to provide the conditions of the ionosphere, the US could monitor radio transmissions between foreign government and military systems that were refracted from the ionosphere. One such system operated at 28 MHz, prompting the use of sporadic E-layer refraction for interception of foreign signals of interest.

The specified purpose for the oblique sounder was to receive, record, and display the echoes of the transmitted pulse. The reflected signals were used to determine sporadic-E conditions, magnetic field-aligned inequalities, disturbances in the F-region, and possible tilt of the ionosphere. Software was written to analyze the data collected by the sounder. Operational results of this system currently fall under high levels of security classification.

## Current Day

Today, the most common system used is the ionosonde, a vertical incidence pulsed radar operating at a frequency range of about 1 MHz to 40 MHz. The measurement is based on the equation:  $h = 0.5 \times c \times t$ , where  $c$  = the speed of light,  $t$  = is the travel time of the pulse, and  $h$  is the layer height (or virtual height).

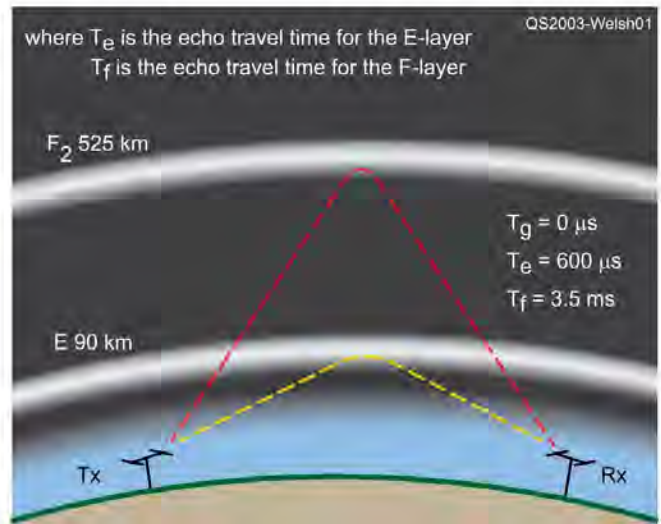

**Figure 1** — A low-power ionosonde simultaneously measures seven observable parameters of reflected signals received from the ionosphere to estimate the height of the ionosphere. Here,  $T_e$  is the echo travel time for the E-layer, and  $T_f$  is the echo travel time for the F-layer.

Among other ongoing research to study the ionosphere, the University of Massachusetts Lowell Center for Atmospheric Research has developed a low-power (300 W) ionosonde (Digisonde™) which has the capability of portable operation with simultaneous measurement (see Figure 1) of seven observable parameters of reflected signals received from the ionosphere: frequency, range or height, amplitude, phase, Doppler shift and spread, angle of arrival, and wave polarization.

## Impact

Commercial, military, and amateur users of the HF, VHF, and UHF regions of the electromagnetic spectrum owe much to past and present experimenters. They provide the communications community with an understanding of how signals propagate around our planet. As users of the electromagnetic spectrum, we rely on this information to better communicate by radio.

Robert H. Welsh, N3RW, is an Assistant Professor of Physics and Astronomy at Bucks County Community College in Newtown, Pennsylvania, where he is a faculty sponsor of club station KB3YRR. Robert also occasionally performs microwave radio galactic studies at the National Radio Astronomy Observatory in Green Bank, West Virginia. He was part of the Microwave Galactic Plane Survey using a dual-frequency radio telescope operating at 9.7 GHz and 14.3 GHz. Robert is an active chaser for DX entities and Islands on the Air.

**For updates to this article, see the QST Feedback page at [www.arri.org/feedback](http://www.arri.org/feedback).**



# ARRL *Eclectic Tech*

Starting February 13, you'll have a new podcast for your listening pleasure. Hosted by Steve Ford, WB8IMY, ARRL's *Eclectic Tech* will treat you to a broad discussion of science and technology as it applies to amateur radio, including new technology that may impact the future of amateur radio — for better or worse.

Every 2 weeks, *Eclectic Tech* will bring you interviews with individuals who are involved in innovative projects. You'll also gain tips about existing activities and technologies you might want to explore, as well as commentary about the evolving state of the radio art.

In the first episode, you'll get the latest predictions for the current solar cycle from Carl Luetzelschwab, K9LA, and his advice about how to deal with what the next few years may bring. You'll hear what a DX pileup sounds like on QO-100, a satellite with the world's first geostationary amateur radio transponder. And you'll hear ARRL Laboratory Test Engineer Bob Allison, WB1GCM, describe his project of testing handheld transceivers for spectral purity, and why you should care about the results.

## A New Technical Podcast for Amateur Radio!

Listen anytime with your mobile device, or your desktop or laptop computer.

### Join the Podcast Revolution

Podcasts have become wildly popular and there are nearly 1 million available on almost every topic imaginable. In fact, some are describing podcasting as the "new radio."

If you've never listened to a podcast, think of it as a broadcast radio show, but one that you enjoy on *your* schedule. A podcast comes to you as an audio file that you can download and play on your mobile device or enjoy via your desktop or laptop computer. You can listen to a podcast whenever you desire; start and stop or skip forward or backward as you wish. You are in total control.

Enjoy *Eclectic Tech* while you commute to work. Listen while relaxing at home. Download to your mobile device and take it with you on your next trip.

If you want to listen on an Apple device, you may find that Apple's podcast app is already installed. If not, you can download it from the Apple App Store.



Android users may want to try the Stitcher app from Google Play. Once you have the apps installed, use their search functions to find ARRL's *Eclectic Tech*. Be sure to subscribe so that you don't miss a single episode. (Subscribing is free.)



Of course, you can also listen with your laptop or desktop. Just open a web browser and go to the Blubrry hosting site at [blubrry.com/eclectictech](http://blubrry.com/eclectictech). Click the **PLAY** button on the episode you want and enjoy!

Comments or suggestions? Email [eclectic@arrl.org](mailto:eclectic@arrl.org).



# The Saga of Clipperton Island



The masked boobies are very common on Clipperton Island. [Robert Schmieder, KK6EK, Cordell Expeditions, photo]

This DX entity (FO/C) frequently ranks high on Club Log's Most-Wanted List, but the island is also infamous for its long, turbulent history.

## Allison McLellan

Those who have journeyed 700 miles southwest of Acapulco, Mexico, to Clipperton Island include pirates, castaways, military personnel, scientists, and amateur radio operators. As a DX entity, Clipperton (FO/C) currently ranks number 45 worldwide on Club Log's Most-Wanted List, and number 35 in Europe. The island tends to stay relatively high in DX ranking, in part due to its remote and inhospitable shores.

## Far From Paradise

The 2.3-square-mile atoll of Clipperton is a flat ring of land surrounding a lagoon, with its most distinguishing feature being Clipperton Rock — the 70-foot-tall remains of the volcano that formed the island in its isolated area of the Pacific. The rough reefs surrounding its coast create a tumultuous surf, but those who end up in an overturned boat have more to worry about than sharp coral. Clipperton is known for an abundant shark population, with frequent sightings of moray eels.

After making it to shore, there is the environment to contend with. Scarce vegetation lends little shade due to the large crab population depleting greenery. The island is also known for its many seabirds and subsequent abundance of guano — bird waste that is high in phosphate, making it a valuable resource as fertilizer. At one point, the Mexican government brought wild pigs to the island that ate the bird eggs and crabs, allowing some vegetation growth. However, the animals were also said to “drive men into the surf” with their tusks, and eventually, the pigs were killed off to preserve the natural habitat.<sup>1</sup>

Despite short periods of human occupation, the area is considered to be among the least disturbed ecosystems in the Pacific.<sup>2</sup> In recent years, National Geographic research teams conducted dives and land surveys at Clipperton and concluded, “The beautiful nearshore reefs — measured in species per area — held the highest number of endemic species anywhere in the world.”<sup>3</sup>

## An Island in Demand

Before it became a destination for rare Amateur Radio contacts, Clipperton Island was at the center of an ownership dispute between France, Spain, Mexico, and the United States. The island was discovered by Ferdinand Magellan in 1521, and later named after the English pirate John Clipperton. According to legend, Clipperton left treasure hidden on the small island.

In 1858, France wanted to claim the land, but its boats could not make it to shore. The crew settled for circling the island in their ship while reading a proclamation of ownership and left it at that. However, in 1892, the US annexed Clipperton under the Guano Islands Act of 1856, which declared “any guano islands unclaimed or unoccupied by others could be claimed and mined, and the guano delivered to the United States at a low price for the benefit of its citizens.”<sup>4</sup> But the expenditure did not prove to be very lucrative, especially with the expense of shipping supplies to mining crews on the island.

With Clipperton’s proximity, it was Mexico’s turn to stake claim on the island, and it did not take much to do so. A group of Mexicans sailed over and distracted the miners long enough to replace the American flag atop a 40-foot-pole with a Mexican one. As the island was becoming more trouble than it was worth, the US conceded.

Thus, the dispute continued between Mexico and France, and Mexico sent a 13-man army to protect its claim. Soldiers’ servants and wives accompanied them and bore children, eventually growing to a population of 26. However, as the Mexican government

was forced to divert resources to its rising revolution, attention on the settlement dwindled until suddenly, supply ships stopped coming. Left isolated on Clipperton’s unforgiving soil with only birds, eggs, and fish to eat, many developed scurvy and succumbed to illness — especially the men. With one boat too low on fuel to reach land and the five remaining men too weakened to sufficiently row, escape options were limited. Nevertheless, in an effort to reach a ship believed to be seen on the horizon, the men took the canoe to sea, but capsized and drowned. Not long afterward, a hurricane tore through the settlement.

Emerging among the wreckage, the Clipperton lighthouse keeper — the only remaining man on the island who had since stayed isolated in his lighthouse quarters — declared himself king. He took control of the weapons and abused the women into servitude for nearly 2 years. Finally, in July 1917, two of the women were able to overpower and kill the lighthouse keeper, ending his reign of terror. The three women and eight children were soon rescued by the American USS *Yorktown*, which was in the area patrolling for German U-boats.

► A historical map of Clipperton Island. [Photo courtesy of University of Texas Libraries, Geographical Handbook Series: Pacific Islands, Vol. II: Eastern Pacific, Naval Intelligence Division: 1943]

▼ Aerial photo of Cordell Expedition’s TX5K camp. [Robert Schmieder, KK6EK, Cordell Expeditions, photo]

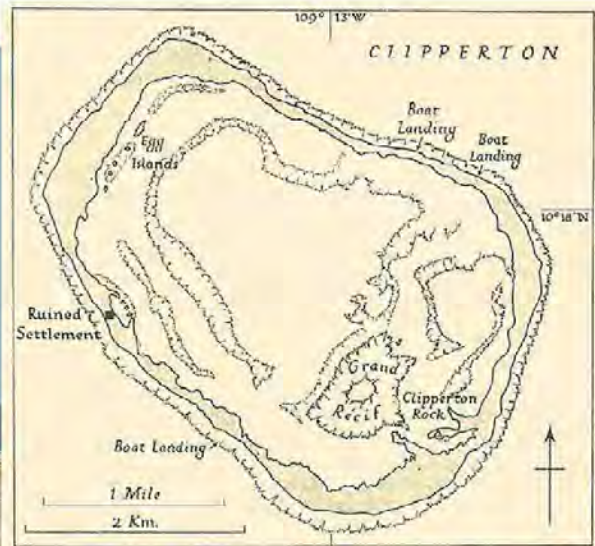

Following the island's desertion, France approached the Vatican to settle the ownership dispute with Mexico, and the decision was turned over to King Victor Emmanuel III of Italy. A 1936 decree established Clipperton under the Government of the French Establishments of Oceania.<sup>5</sup>

Afterwards, the French briefly used the island for a military outpost, leaving after 7 years. Throughout World War II, the US Navy occupied the island under secretive operation. In 1998, NASA constructed an expensive tracking facility there, but it, too, was abandoned only months later. Since then, the island has remained virtually uninhabited — save for the occasional DXpedition.

### Amateur Radio on Clipperton

According to the German DX Foundation ([www.gdxf.de/megadxpeditions](http://www.gdxf.de/megadxpeditions)), there have been five “mega” DXpeditions to the entity. In 1985, FO0XX achieved 30,958 contacts; in 1992, FO0CI reached 46,044; FO0AAA hit 75,107 in 2000; TX5C obtained 71,798 in 2008, and the large TX5K team got a whopping 113,603 in 2013. But given the very nature of Clipperton, these DXpeditions could not be without obstacles.

Robert Denniston, W0NWX, was the first to lead a crew as FO8AJ in 1954, an endeavor plagued by what he called “a permanent state of bad luck” in the July 1954 issue of *QST*. Following a struggle to find suitable transportation, the crew's sextant broke on their second night at sea, leaving them unable to navigate. After a week, they were forced to return to the mainland, seasick and disheartened.

When FO8AJ finally coordinated a new ride to Clipperton, the journey was filled with more issues, including oil and water leaks, torn sails, and a dead battery in the ship's system. They gained sight of the elusive island by nightfall of the sixth day, but it was too dark to land. By daybreak, they had been pushed off course by wind, and the boat engines quit just in time for an approaching storm. The overcast sky made it impossible to navigate for days, until the rain cleared on the one day of the year when the sun is directly overhead, making navigational readings unreliable.

The next day, the team finally obtained a location measurement and made it to Clipperton. Despite a damaged generator causing noise in the receiver, contacts were successful, particularly on 20-meter CW. The



The Cordell Expedition's Clipperton DXpedition team and their banners. [Robert Schmieder, KK6EK, Cordell Expeditions, photo]

hams remained on the air until the last possible moment, when the Mexican Navy ordered their departure, garnering a total of 1,108 contacts over 18 hours of operation.

The DXpeditions following Denniston's pilgrimage did not get much easier. The 1985 FO0XX team was forced to circle the island for 4 days in a tropical storm before they could battle ashore. Their first 2 days were full of storms that ravaged their camp, and during fierce operation pileups, they found the island's crabs, birds, and roaches were not particularly afraid of people. It wasn't all a struggle; on the third day, a helicopter pilot working with a tuna fishing company came across the operators and gave them their only 2-meter contact with his chopper's Kenwood radio. Then he flew the team to the fishing ship for a guided tour, where they were refreshed with cold drinks, fresh food, and brandy.

The 2000 FO0AAA DXpedition fared better with an experienced ship crew that frequented Clipperton Island for fishing trips. However, the team was greeted with an hour of intense rain and wind as soon as they got to shore. The exhausted men settled into bed for what FO0AAA team member Michael Goode, N9NS, called, “Without reservation, [the] worst night in my life,” with a carpet of crabs scuttling below his cot.<sup>6</sup> But the team enjoyed exploring the location and its ruins from the abandoned military operations and settlements. As they packed up their gear, Goode said the team was both happy and sad to go home.



With such a hostile environment, it's a wonder Clipperton is ever selected as a DXpedition destination. Dr. Robert Schmieder, KK6EK, of Cordell Expeditions, helped organize the 2013 TX5K DXpedition, which brought a five-person team of scientists to monitor the island environment in addition to operation. This research component was essential in funding the trip, and the group was able to collect samples to identify a new microscopic animal on the island.

"Clipperton is an astonishing physical object — in the remote ocean, here is a ring of sand, 7 miles around, populated by various flora, fauna, and ruins of previous occupations," Schmieder said. "It's a romantic place, tied to pirates and a continuing series of scientific projects. And it's a visually spectacular atoll."

Regardless of destination, any DXpedition can be a harrowing process, from planning logistics to operating for hours on end. For radio amateurs, it's all worth it to make thousands of contacts from a new location and bond with fellow hams. Clipperton Island has remained stubbornly untamed for hundreds of years, but if a ham

is brave enough to test its waters, the adventure may at least be worth the story.

**Notes**

- <sup>1</sup>R. Dennison, W0NWX, "DXpedition to Clipperton," *QST*, July 1954, pp. 10 – 15.
- <sup>2</sup>M. Jenkins, C. Sheppard, and S. Wells, *Coral Reefs of the World*, Volume 3: Central and Western Pacific (Nairobi, Kenya: UNEP; Gland, Switzerland: IUCN, 1988).
- <sup>3</sup>P. Rose, "Why Clipperton Island is a 'Beautiful, Powerful Surprise!'" National Geographic Society Newsroom, Mar. 24, 2016, <https://blog.nationalgeographic.org/2016/03/24/why-clipperton-island-is-a-beautiful-powerful-surprise/>.
- <sup>4</sup>"The Guano Islands Act of 1856," National Museum of American History — Behring Center, <https://americanhistory.si.edu/norie-atlas/guano-islands-act>.
- <sup>5</sup>J. Pike, "Clipperton/Ile de la Passion — History," July 24, 2017, <https://www.globalsecurity.org/military/world/oceania/cp-history.htm>.
- <sup>6</sup>M. Goode, N9NS, "Clipperton 2000," *QST*, Feb. 2001, pp. 54 – 58.

Allison McLellan is a writer based in the New York area. She can be reached at [almmclellan@gmail.com](mailto:almmclellan@gmail.com).

For updates to this article, see the *QST* Feedback page at [www.arrl.org/feedback](http://www.arrl.org/feedback).

**VOTE**  
If you enjoyed this article, cast your vote at [www.arrl.org/cover-plaque-poll](http://www.arrl.org/cover-plaque-poll)

# Congratulations

**December 2019  
QST Cover Plaque  
Award Winner**

**John Portune  
W6NBC**

"Slot-Cube Antenna for 6 Meters" by John Portune, W6NBC, offered an interesting approach to building an omnidirectional antenna for 6 meters using little more than copper pipe. John will receive a handsome plaque featuring the cover of the December issue.

QST Cover Plaque Awards are given to the author or authors of the most popular article in each issue.

You choose the winners by casting your vote online at

[www.arrl.org/cover-plaque-poll](http://www.arrl.org/cover-plaque-poll)

Log in now and pick your favorite article in this issue!

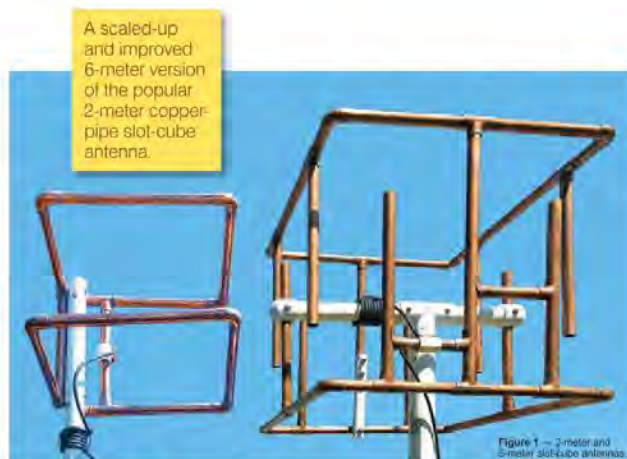

Figure 1 — 2-meter and 6-meter slot-cube antennas

## Slot-Cube Antenna for 6 Meters

**John Portune, W6NBC**

In the January 2019 issue of *QST*, I introduced the slot-cube, a remarkably small 2-meter base station antenna, with similar gain to a J-pole, and, like the popular homebrew version, soldered together from 1/2-inch copper water pipe. In response, I've received a flood of emails and photos from around the world, and many have wanted to know if the design can be scaled up to 6 meters. Figure 1 shows my 16-inch 6-meter slot-cube antenna, only 60% bigger than its popular 2-meter cousin.

**Hamspeak**  
*Definition alert*

A classical wide-plane, narrow slot antenna in which the plane is reduced to a narrow conductor (a skeleton) and the slot widened to fill the space.

**How Slot Cubes Work**

Slot cubes are folded skeleton slot antennas bent into a cube to reduce size. The Japanese "Hentenna," found widely on the Internet, is a straight version of the skeleton slot. To adapt the 2-meter design to 6 meters, one needs to reduce the size even more. Simply scaling up the 2-meter slot cube in the same copper pipe makes for a heavy and large antenna on 6 meters. Therefore, I folded the slot one more time, adding open-ended vertical elements with caps (for rain; not yet installed in

# Nominations Now Being Accepted for 2020 McGan Silver Antenna Award for Excellence in Public Relations

This annual award honors successful volunteer efforts  
to keep amateur radio in the news.

ARRL Public Information Officers (PIOs) and other volunteers work hard every day to create a better understanding by the public of all that amateur radio has to offer. They publicize special events, write press releases, and give interviews on radio, television, or in newspapers to highlight the value and service that amateur radio provides. Their efforts benefit us all.

As a way of recognizing these efforts, the ARRL Public Relations Committee solicits nominations for the Philip J. McGan Memorial Silver Antenna Award, which is presented annually to an amateur radio operator who has demonstrated success in his or her public relations efforts on behalf of amateur radio and who best exemplifies the volunteer spirit of Philip McGan.

McGan, WA2MBQ (SK), a journalist himself, was the first chairman of the ARRL's Public Relations Committee, which helped reinvigorate ARRL's commitment to public relations. To honor McGan, members of the New Hampshire Amateur Radio Association joined with the ARRL Board of Directors to establish an award that would pay lasting tribute to the important contributions he made on behalf of amateur radio.

Public relations activities for which the McGan Award is presented include efforts specifically directed at bringing amateur radio to the media's and public's attention in a positive light. This may include traditional methods, like sending out news releases or arranging interviews, or less-traditional methods, such as hosting a radio show or being an active public speaker.



The award is named for the late journalist Philip J. McGan, WA2MBQ, who served as the first chairman of ARRL's Public Relations Committee.

The ARRL Board of Directors will choose the award winner at its July 2020 meeting, based on recommendations from the ARRL Public Relations Committee, which reviews the nominations and accompanying submitted material.

Recent winners of the award include:

- John Wells, W4CMH (2019)
- E. Gordon Mooneyhan, W4EGM (2018)
- Dennis Moriarty, K8AGB (2017)
- Tom "Tex" Ritter, WY7KY (2016)
- Randy Thompson, K5ZD (2015)

The award is given only to an individual (not a group), who must be a full ARRL member in good standing at the time of nomination. The nominee must not be compensated for any public relations work involving amateur radio (including payment for articles), and may not be a current ARRL officer, director, vice director, paid staff member, or a member of the ARRL Public Relations Committee.

The nominee's efforts must fit the definition of public relations, which is fundamentally about getting a message out to people, as opposed to public service, which is about providing service to the community. The McGan Award is for promotion of amateur radio to the non-amateur radio community; it is not awarded for work done within a club or organization that primarily benefits the amateur radio community.

Nominations must be received at ARRL Headquarters in Newington, Connecticut by the **close of business on Friday, May 15, 2020**. Nominations must be on an official entry form, which can be found and downloaded in PDF format from [www.arrl.org/phil-mcgan-award](http://www.arrl.org/phil-mcgan-award). Anyone may make a nomination.

## Happenings

# Volunteer Monitor Program Coordinator Looks Forward to a Positive 2020



In a message to ARRL leadership and members of the new ARRL Volunteer Monitor (VM) program, its coordinator, Riley Hollingsworth, K4ZDH, expressed gratitude to all involved for their contributions to getting the program off to a solid start in January.

"It will be a good year," Hollingsworth said. "We will have fun, you will enjoy it more than you probably think, and thanks to the talent and generosity of one of our VMs, a computer program will make your reporting much easier (there will be no need for bimonthly reports!)," he wrote. "This is our opportunity to help amateur radio last another hundred years and to pay forward this wonderful avocation that joyfully occu-

pies our lives. This could be our legacy if we do it with all the energy and devotion that characterized the Official Observer (OO) program for decades."

Hollingsworth said the success of the OO program convinced the FCC to trust ARRL with the responsibilities now being taken up by the Volunteer Monitor program. "Those of you who are former OOs have an extra reason to be proud, and amateur radio is grateful to you more than you will ever know," Hollingsworth concluded. "Thank you. It will be a privilege to work with you this new year."

Approved by the ARRL Board of Directors in 2018, the Volunteer Monitor program supplants the venerable OO program. The VM program represents a formal agreement between the FCC and ARRL in which volunteers trained and vetted by ARRL will monitor the airwaves and collect evidence that can be used to correct misconduct. The program will also recognize exemplary on-air operation. ARRL will refer cases of alleged flagrant violations to the FCC.

The FCC proposed the new program in the wake of several FCC regional office closures and a reduction in field staff. It will give enforcement priority to cases developed by the Volunteer Monitor program without ARRL's having to refer cases through the FCC online complaint process.

### ARRL On the Air Podcast Premieres

ARRL's new *On the Air* podcast for those just getting started on their amateur radio journey debuted in mid-January, with a new episode posted each month. The podcast is a companion to the new bimonthly *On the Air* magazine. *On the Air* magazine's Editorial Director Becky Schoenfeld, W1BXY, is hosting the new podcast. Both the podcast and the magazine are aimed at offering new and beginner-to-intermediate-level radio amateurs a fresh approach to exploring radio communication.

Listeners can find the podcast at Blubrry, Apple iTunes (or by using your iPhone or iPad podcast app — search for "*On the Air*"), and Stitcher (or through the free Stitcher app for iOS, Kindle, or Android devices). Episodes will be archived on the ARRL website.

Each episode will take a deeper dive into the articles and issues raised in the magazine, including advice and insight on topics covering the range of amateur radio interests and activities: radio technology, operating, equipment, project building, and emergency communication.

A new Facebook page ([www.facebook.com/ARRLOTA](https://www.facebook.com/ARRLOTA)) will supplement the *On the Air* podcast.



## ARISS Next-Generation Radio System Ready for Launch to Space Station

Amateur Radio on the International Space Station (ARISS) reports that its first Interoperable Radio System (IORS) flight unit — serial number 1001 — has been delivered to NASA's Johnson Space Center for launch in early March. The IORS represents the first major upgrade in ARISS equipment on the International Space Station since amateur radio gained a permanent presence onboard the ISS in 2000. Last December, ARISS received approval from NASA Safety to launch the IORS on SpaceX CRS-20 and stow the radio system on the ISS for future installation.

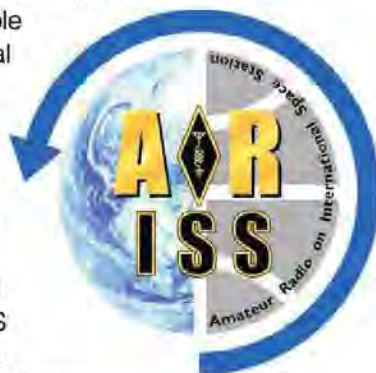

"The IORS is a foundational element of the ARISS next-generation radio system and is an incredible engineering achievement by the ARISS hardware team," ARISS International President Frank Bauer, KA3HDO, said. "This first element delivery will support easier radio mode transitions and enable new, exciting capabilities for hams, students, and the general public."

The new system includes a higher-power radio, an enhanced voice repeater, and updated digital packet radio (APRS) and slow-scan television (SSTV) capabilities for both the US and Russian space station segments. The IORS consists of a custom-modified JVC Kenwood TM-D710GA transceiver, an AMSAT-developed multi-voltage power supply, and interconnecting cables.

The IORS, set to launch in March, will be installed in the ISS *Columbus* module; a second flight unit is expected to be launched later this year for installation in the Russian *Service Module*. The ARISS hardware team will assemble four flight units — and 10 IORS units in all — to support onboard flight operations, training, operations planning, and hardware testing.

"Future upgrades and enhancements to the next-generation system are in various stages of design and development," Bauer said. "These include a repaired Ham Video system — currently planned for launch in mid-to-late 2020 — L-band (uplink) repeater, ground command operations capability, LimeSDR signal reception, a microwave 'Ham Communicator,' and Lunar Gateway prototype experiment."

Bauer said a lot of "heavy lifting" remains to prepare the IORS for operation on the space station. "ARISS has 92 engineering requirements and our operations Phase III safety review to complete," he explained. "The space agencies take a position of 'trust, but verify.' Thus, these engineering and safety 'verifications' all need to be closed out before the IORS can be unstowed and turned on."

Bauer reminded that ARISS is almost entirely run by volunteers and encouraged donations for next-generation hardware developments, operations, education, and administrative functions. Donations can be made at [www.ariss.org/donate.html](http://www.ariss.org/donate.html).

## Radio Amateurs of Canada Announces a New Section

The number of Sections needed for a clean sweep in the ARRL November Sweepstakes (SS) will rise to 84 in 2020, with the addition of a new Prince Edward Island (PE) Section. Radio Amateurs of Canada (RAC) has announced that the new Section will become effective April 1. Prince Edward Island has been in the Maritimes (MAR) Section.

RAC said its Prince Edward Island members have been working for some time to create a separate Section for RAC ARES activities there. The provinces of Nova Scotia and New Brunswick will remain in the Maritimes Section.

In addition to Field Day and Sweepstakes, the new Section in Canada will affect the ARRL 160-Meter Contest but *not* the ARRL 10-Meter Contest, which uses individual states/provinces for US and Canadian multipliers. The change will mean that logging software developers will have to update their software to include the PE Section as a valid exchange element for any affected operating events.

RAC also announced that, effective April 1, radio amateurs in the City of Hamilton and in the Regional Municipality of Niagara will shift to the Greater Toronto Area (GTA) Section from the Ontario South (ONS) Section.



## China Telecoms Regulator Proposing to Delete Some Current Amateur Allocations

China's telecommunications regulator has proposed amending the *Measures for the Administration of Amateur Radio Stations*, and some amateur bands are in danger of being eliminated. The proposal would prohibit amateur operation on the 2200-meter band as well as on 146 – 148 MHz, 1260 – 1300 MHz, 3400 – 3500 MHz, 5650 – 5725 MHz, and all bands above 10 GHz.

Radio communications engineer and Chinese Amateur Satellite Group (CAMSAT) CEO Alan Kung, BA1DU, told ARRL that government efforts to eliminate some amateur bands are nothing new, but proposals that have been aired for a while now are on the regulatory agency's schedule. Kung said he does not anticipate that all of the bands proposed will be taken away, but he conceded that the climate will "undoubtedly" become increasingly dangerous for China's amateur radio community.

"The attempt to crowd out the amateur radio bands has a long history throughout the world," he said, "but it may never have become so urgent for the amateur radio community as it is today. We all understand that radio spectrum resources have become a bottleneck for further development." He said today's radio communication industry "is working hard to share spectrum resources."

## New Section Manager Taking Over in North Carolina

Marvin Hoffman, WA4NC, takes the reins of the North Carolina ARRL Field Organization on April 1. Hoffman, of Boone, was the sole nominee to succeed incumbent Section Manager Karl Bowman, W4CHX, who decided not to run for a new term after serving since 2014. Because no challengers came forward by the nomination deadline, no contested SM elections took place during the winter election cycle.

These incumbent Section Managers begin new terms on April 1: John Fritze, K2QY, Eastern New York; George Miller, W3GWM, Eastern Pennsylvania; John Mark Robertson, K5JMR, Louisiana; Joe Speroni, AH0A, Pacific; Dave Kaltenborn, N8KBC, San Diego; Chris Stallkamp, KI0D, South Dakota, and Joe Palsa, K3WRY, Virginia.

Elsewhere, John Litz, NZ6Q, was appointed in January as ARRL San Joaquin Valley Section Manager, succeeding Dan Pruitt, AE6SX, who passed away on December 27. He had served as SJV SM since 2009. Litz will complete the remaining term of office that runs through June 30, 2021. From Stockton, California, Litz was first licensed in 1974 and is an ARRL Life Member. He had been serving as an Assistant Section Manager in San Joaquin Valley.

## Nominations Solicited for Six ARRL Awards

ARRL is inviting nominations for awards that recognize educational and technological pursuits in amateur radio. Nominations are also open for ARRL's premier award to honor a young licensee.

**The Hiram Percy Maxim Award** recognizes a radio amateur and ARRL member younger than age 21, whose accomplishments and contributions are of the most exemplary nature within the framework of amateur radio activities. Nominations for this award are made through ARRL Section Managers, who will forward nominations to ARRL Headquarters. The deadline is March 31, 2020.

**The ARRL Herb S. Brier Instructor of the Year Award** honors an ARRL volunteer amateur radio instructor or ARRL professional classroom teacher who uses creative instructional approaches and reflects the highest values of the amateur radio community. The award highlights quality of and commitment to licensing instruction. Nominations are due by March 16, 2020.

**The ARRL Microwave Development Award** pays tribute to a radio amateur or group of radio amateurs who contribute to the development of the amateur radio microwave bands. The nomination deadline is March 31, 2020.

**The ARRL Technical Service Award** recognizes an individual radio amateur or group of radio amateurs who provide amateur radio technical assistance or training. The nomination deadline is March 31, 2020.

**The ARRL Technical Innovation Award** is conferred on an individual radio amateur or group of radio amateurs who develop and apply new technical ideas or techniques in amateur radio. The nomination deadline is March 31, 2020.

**The Knight Distinguished Service Award** recognizes exceptional contributions by a Section Manager to the health and vitality of ARRL. The nomination deadline is April 30, 2020.

The ARRL Board of Directors selects award recipients, and winners are typically announced following the Board's July meeting. For more information about these awards, visit [www.arrl.org/arrl-award-nominations](http://www.arrl.org/arrl-award-nominations), or contact Steve Ewald, WV1X, at [vv1x@arrl.org](mailto:vv1x@arrl.org) or 860-594-0265.

## In Brief...

■ **The Boy Scouts say JOTA station participation was up in 2019.** Although overall Jamboree On the Air (JOTA) 2019 participation was down slightly from 2018, “our calculations show that each station averaged an additional 13 people in attendance over 2019,” the Scouts said. “This shows an aggregate increase of 24% attendance per station, even with our reported stations being down from 266 in 2018 to 201 in 2019.” The Scouts reported that 13,783 individuals took part in JOTA 2019, down from 14,708 in 2018.



■ **Stephen Veader, N4DXS, of Dale City, Virginia, a major behind-the-scenes player in the effort that led to creation of amateur radio's 60-meter band in the US, passed away on November 5.** An ARRL Life Member, he was 67. As a spectrum manager for the National Telecommunications and Information Administration (NTIA), Veader was deeply involved on the behalf of NTIA in the effort to secure a new amateur band at 5 MHz. According to Ross Merlin, WA2WDT, when it became clear that a proposal for a 15 kHz band would not be approved, Veader was instrumental in fashioning the compromise that led to the authorization of the five discrete secondary channels radio amateurs have today, and other countries copied that template for their 5 MHz amateur allocations. Today, these spot frequencies serve as “interoperability channels” for federal and amateur stations to share in emergencies and exercises. — *Thanks to Ross Merlin, WA2WDT*



■ **CAMSAT's CAS-6 activation for amateur use has been delayed.**

Some problems with the precise attitude determination of CAS-6 were reported to be delaying antenna deployment. The satellite was to have been put into service within 3 days of launch. Work to resolve the issue was to be completed sometime in late February or early March. The satellite's 145.910 MHz CW beacon has been turned on, although the antenna had not yet been deployed. — *Thanks to Alan Kung, BA1DU*



■ **The lead developer of the bar code system that became the now-ubiquitous Universal Product Code (UPC), George Laurer, K4HZE, of Wendell, North Carolina, passed away on December 5.**

He was 94. While an electrical engineer with IBM in North Carolina's Research Triangle Park in the early 1970s, Laurer led the effort to develop the bar code system. The UPC, composed of 30 unique black bars and a 12-digit number, allows retailers to identify products and prices as they are scanned. It was used for the first time in a retail setting in 1974. A native of New York, Laurer graduated from the University of Maryland in 1951 and spent 3 decades working for IBM. Accounts describe Laurer as an inveterate tinkerer, even up to his final years.



■ **YOTA Month was a success in the Americas.** For the last several years, Youngsters on the Air (YOTA) has sponsored YOTA Month each December, primarily involving young radio amateurs in Europe and Africa. This past December, youth-operated amateur radio stations in the Americas picked up the ball to contribute more than 12,000 contacts to the worldwide total of some 129,000 contacts. In the US, 15 operators aged 25 or younger deployed special event 1 × 1 call signs — K8Y, K8O, K8T, and K8A — to call attention to the event and to youth in amateur radio. “My favorite part of YOTA Month was getting the wonderful experience of talking to other youth all over the world and sharing our experiences,” said Audrey McElroy, KM4BUN. Her brother Jack, KM4ZIA, also took part.



## Public Service

# Southern California Hams Deploy to Combat Wildfire Threats

*Ray Hutchinson, AE6H, is an Orange County Fire Watch (OCFW) Team Leader, a retired Orange County Fire Authority (OCFA) Fire Captain, and the current president of the South Orange Amateur Radio Association (SOARA) based in Mission Viejo, California.*

Wildfires with the resulting destruction of valuable watershed and timberlands, along with the potentially devastating loss of life, homes, and businesses, are a constant threat to the western US and many areas of the southeast. A dry, Mediterranean-type climate with frequent and pervasive periods of drought, coupled with steady seasonal wind events within vast areas of wild land, create an environment ripe for wildfire devastation. One southern California county has established a program to help combat this problem, employing ham radio volunteers as a key component. This effective program could serve as an inspiration and model for many other areas of the US, and even other parts of the world where wildfires constitute a significant threat.

### Establishing a Fire Watch

Originally established in 2007 after several serious wildfires occurred in rapid succession, the Irvine Ranch Conservancy (IRC) in Orange County, California trained volunteer corps it had already established to work on other areas of conservation to help prevent and detect wildfire events. These trained volunteers were deployed during high fire danger weather conditions known as Red Flag Warnings. These events are declared by the National Weather Service (NWS) and are universally used throughout the fire service and

other emergency response agencies for planning and staffing of enhanced activities and responses.

Two years later, the Orange County Board of Supervisors tasked the Orange County Parks Department (OCP) — which manages over 60,000 acres of wilderness parkland, open space, and shoreline — with devising a similar volunteer program.

A study was conducted by the Orange County Fire Authority (OCFA) to determine and map the points of origin for hundreds of wildfires throughout the county. They found that over 90% of the ignitions occurred along major roadways and at points of entry to the wild land areas such as trailheads. They determined that 98% of these fires were the result of human activity, either by deliberate acts such as arson, or by accident.

Based on these studies, a plan was devised and implemented, consisting of a combination of educational programs, deterrence, and early detection. With hundreds of miles of susceptible roadways and numerous wild land entry points, already tight budgets were insufficient to provide the needed staffing to watch over these areas. Because the IRC and the OCP already had active



Orange County Fire Watch (OCFW) ham volunteers Bill Frey, K6FRY, (left) and Ray Hutchinson, AE6H, (right) present wildfire prevention information at a public education event.

volunteer programs in place, combining and expanding those volunteer programs solved the budget concern. Management of the program was then placed in the hands of the IRC (with heavy participation and support from OCP) and the Orange County Fire Watch (OCFW) organization was established.

### Training and Deployment

Currently, the OCFW is directed by Tony Pointer, a full-time Program Manager employed by the IRC, and the program is a combined effort by the IRC, OCP, and OCFA agencies. The roster has over 360 trained volunteers, 53 of which are licensed amateur radio operators. These volunteers undergo a criminal background check and receive 3 days of training on topics that include dealing with the public and difficult persons, fire weather, wildfire behavior, reporting procedures, communications, and

personal safety. First aid and CPR training and certification is included. Upon satisfactory completion of training, volunteers are issued OCFW identification cards, uniform shirts and baseball caps, a first aid kit, a deployment manual, large vehicle identification magnetic door placards, and a distinctive high-visibility vest.



Joan Steiner, KJ6AIK, on OCFW deployment.

Whenever the NWS declares a Red Flag Warning for the Orange County weather zones, a cell phone call, text alert, and email is immediately sent by the program manager notifying volunteers of the OCFW deployment. Volunteers then go online to register for shifts at one of the 35 designated OCFW deployment locations, or to assist in the Operations Center. A Fire Watch Communications Net is established from the Operations Center via the South Orange Amateur Radio Association's (SOARA) high level 5,700-foot UHF repeater, which can be utilized by OCFW hams from all 35 deployment locations. Because of the many hills and topography of the canyon areas of the county, cellular service is not always available. Special care is taken to assign ham OCFW volunteers to remote locations with limited or no cell service. Fire watch ham volunteers report their current wind and weather conditions, as well as any other noteworthy but non-emergency occurrences. Emergencies are reported to 911 by the deployed volunteers, and then immediately to the Operations Center by radio. In areas with no cell service, emergencies are reported directly to the Operations Center by amateur radio for relay to 911.

## Decreased Wildfires

Since the inception of the OCFW program, volunteers have dedicated over 18,000 hours to help prevent wildfires through public education, visible reminders, deterrence, and early detection. In 2018 alone, volunteers gave 3,333.5 hours to the program, including 12 days of Red Flag deployments, and 25 public education and outreach program presentations. Major partners in the OCFW program are the Orange County Parks, the Irvine Ranch Conservancy, and the Orange County Fire Authority. Other cooperating agencies include the NWS, SOARA, the Orange County Sheriff's Department, Orange County Radio Amateur Civil Emergency Services (RACES), Crystal Cove State Park, and the US Forest Service Cleveland National Forest.

Notably, with the establishment of the official Orange County Fire Watch program, the number and severity of wildfires in Orange County has been greatly reduced. While it's impossible to quantify the number of fires prevented, it's clear that the program has had a significant and beneficial impact. Groups or agencies who are interested in more information about how their jurisdictions might establish a similar program are welcome to contact OCFW Program Manager Tony Pointer at [tpointer@irconservancy.org](mailto:tpointer@irconservancy.org), or Ray Hutchinson, AE6H, at [ae6h@soara.org](mailto:ae6h@soara.org). You may also visit [www.orangecountyfirewatch.org](http://www.orangecountyfirewatch.org) for more information.

## Field Organization Reports

December 2019

### Public Service Honor Roll

This listing recognizes radio amateurs whose public service performance during the month indicated 70 or more points in six categories. Details on the program can be found at [www.arrl.org/public-service-honor-roll](http://www.arrl.org/public-service-honor-roll).

494 WA7PTM	189 KV8LY	122 WD8USA	WB4RJJW KZBQ	84 W4INK N2RQ KB1NMO
410 KD8TTE	180 WB9WKO	120 WA4VGZ W4NWT	WB7OSC KN9P AD3J KB2QQ	83 K8AMH N6IET
371 W7PAT	168 WM2C	168 WC4FSU K3JL KY2D	K3RC AC8RV WB8SIQ KD2MDV	82 AD4DO AB3WG KA0DBK
365 N9VC	156 WS6P	156 W0LAW KE5YTA W7EES WK4WC	N1LAH AA3SB WB3FTQ KB2YAA K8ED	81 K6JT
363 KE8BYC	155 W1RVY N5MKY	119 KA9ZGY KD8ZCM	99 KC1HHO	80 KB4CAU KT4WX KL7RF KF7GC WS4P
325 WA3EZN	153 W8IM WB8RCR	117 W9GRG	96 KA2GQQ K6JGL	95 KF5IOU KB8RCR
260 KW9EMG	150 KB3YRU W4DNA	115 NX9K KC8WH	95 KF5IOU KB8RCR	79 KN4AAG K0FBS
237 AD8CM	145 WO2H	112 N3KRX	93 K1HEJ	77 W5XX KC8YVF
230 WD8MWD	144 WA2BSS	110 KA9MZJ WB8YLO	92 KG5NNA W2CTG K8RDN	76 K4VWK WB8QLT KC7ASA
229 KD2LPM	140 KY2MMM KD8UUB K4IWW WA2CCN	135 K9LJU W3YVQ	90 KM4WHO KD9EAQ KC9FXE K3IN K8LPC K8KRA KD2IWN N2TSO W7PHX KI7TIG KB1NAL WB8WKQ	75 KD2MEN
228 WA2CCN	140 KY2MMM KD8UUB K4IWW WA2CCN	135 K9LJU W3YVQ	90 KM4WHO KD9EAQ KC9FXE K3IN K8LPC K8KRA KD2IWN N2TSO W7PHX KI7TIG KB1NAL WB8WKQ	74 K3YAK
225 KT2D	135 K9LJU W3YVQ	106 K1AUDZ KA5DON	89 KE1ML	73 KA1G
206 K2RMF	130 WB9QPM N2DW WB8YYS N2WGF N2JBA KW1U K1XFC NA7G	105 K2TV WF2Y	88 N3RB KB8HJJ WD0BFO	72 KF4DVF
205 KE8KOC	125 W3GWM AG9G	101 N3SW	85 W4TTO	71 KV8Z K8OV KA2JFU
202 AL0Y	124 KB5PGY K3FAZ KD2GXL	100 NN7H		70 K6RAU
200 KK4PUX W5DY				
195 N8SY WC9CW				
190 K0IBS AC0KQ				

The following stations qualified for PSHR in previous months but were not reported in this column: (Nov.) WA7PTM 428, WS6P 213, WB7OSC 205, W2PH 170, WA2CCN 160, W4CMH 135, N1LL 130, KA9QWC 120, KA2ZNZ 110, KD2IWN 106, W9BGJ, W2PAX, K2RMF, KB2YAA 100, K9DUR 99, AB9ZA 91, WD0BFO, W9EEU 84, KA0DBK 83, WS4P 76, K6RAU 71.

### Section Traffic Manager Reports

The following Section Traffic Managers reported: AL, AR, AZ, CO, CT, DE, EMA, EPA, IL, IN, LA, LAX, MDC, ME, MI, MN, MS, MT, NC, NE, NM, NNJ, NTX, NV, OH, OR, SC, SD, SFL, SJV, STX, TN, UT, VA, WMA, WI, WPA, WTX, WV, WY.

### Section Emergency Coordinator Reports

The following Section Emergency Coordinators reported: AL, AR, AZ, CT, DE, ENY, EPA, EWA, GA, IA, IL, IN, KY, LA, ME, MDC, MI, MN, MO, MS, MT, ND, NFL, NLI, NM, NNJ, NV, OH, OR, PAC, SFL, SJV, SNJ, STX, SV, VA, VI, WNY, WPA, WTX, WV, WY.

### Brass Pounders League

The BPL is open to all amateurs in the US, Canada, and US possessions who report to their SMs a total of 500 or more points or a sum of 100 or more origination and delivery points for any calendar month. Messages must be handled on amateur radio frequencies within 48 hours of receipt in standard ARRL radiogram format. Call signs of qualifiers and their monthly BPL total points follow.

KY2D 1265, NX9K 932, WB9WKO 724, K6HTN 574, N1IQI 605, KW1U 604.



# Contest Corral

# March 2020

Check for updates and a downloadable PDF version online at [www.arrl.org/contests](http://www.arrl.org/contests).

Refer to the contest websites for full rules, scoring information, operating periods or time limits, and log submission information.

Start - Finish Date-Time	Finish Date-Time	Bands	Contest Name	Mode	Exchange	Sponsor's Website
1 1200	1 1400	7	SARL Hamnet 40-Meter Simulated Emergency Contest	Ph	RS and serial	<a href="http://www.sarl.org.za">www.sarl.org.za</a>
1 1200	1 2200	3.5	NSARA Contest	CW Ph Dig	RS(T), county (if NS)	<a href="http://nsara.ve1cfy.net/?page_id=82">nsara.ve1cfy.net/?page_id=82</a>
1 1500	2 0059	3.5-144	North Carolina QSO Party	CW Ph Dig	NC county or SPC	<a href="http://ncqsoparty.org/rules">ncqsoparty.org/rules</a>
2 2000	2 2130	3.5	RSGB 80-Meter Club Championship, Data	Dig	RST, serial	<a href="http://www.rsgbcc.org/hf">www.rsgbcc.org/hf</a>
3 0200	3 0400	3.5-28	ARS Spartan Sprint	CW	RST, SPC, power	<a href="http://arsgrp.blogspot.com">arsgrp.blogspot.com</a>
3 1900	3 2100	3.5	AGCW YL-CW Party	CW	RST, serial, name	<a href="http://agcw.org/index.php/en">agcw.org/index.php/en</a>
4 2000	4 2100	3.5	UKEICC 80-Meter Contest	Ph	4-char grid square	<a href="http://www.ukeicc.com">www.ukeicc.com</a>
5 1800	5 2200	28	NRAU 10-Meter Activity Contest	CW Ph Dig	RS(T), 6-char grid square	<a href="http://nrau.net/activity-contests">nrau.net/activity-contests</a>
5 2000	5 2200	1.8-50	SKCC Sprint Europe	CW	RST, SPC, name, mbr or power	<a href="http://www.skccgroup.com">www.skccgroup.com</a>
7 0000	8 2359	1.8-28	ARRL International DX Contest, SSB	Ph	W/VE: RS + SP, Non-W/VE: RS + power	<a href="http://www.arrl.org/arrl-dx">www.arrl.org/arrl-dx</a>
7 0000	15 2359	3.5, 7, 21, 28, 144	Novice Rig Roundup	CW	Name, QTH, rig and/or NRR number	<a href="http://www.novicerigroundup.org">www.novicerigroundup.org</a>
7 0600	7 0800	7, 14	Wake-Up! QRP Sprint	CW	RST, serial, suffix of previous QSO	<a href="http://qrp.ru/contest/wakeup/333-wakeup-eng">qrp.ru/contest/wakeup/333-wakeup-eng</a>
7 1200	8 2359	1.8-50	SKCC Weekend Sprintathon	CW	RST, SPC, name, mbr or "none"	<a href="http://www.skccgroup.com">www.skccgroup.com</a>
7 1800	8 1359	1.8-28	Open Ukraine RTTY Championship	Dig	2-letter region (state/province/canton, etc.), serial	<a href="http://krs.ho.ua/openrtty">krs.ho.ua/openrtty</a>
8 0700	8 1100	3.5	UBA Spring Contest, CW	CW	RST, serial, UBA section (if ON)	<a href="http://uba.be/hf/contest-rules">uba.be/hf/contest-rules</a>
8 1800	8 2200	3.5	WAB 3.5 MHz Phone/CW	CW Ph	RS, serial, WAB square or country	<a href="http://wab.intermip.net">wab.intermip.net</a>
9 0000	9 0200	1.8-28	4 States QRP Group Second Sunday Sprint	CW Ph	RS(T), SPC, mbr or power	<a href="http://www.4sqrp.com">www.4sqrp.com</a>
11 2000	11 2130	3.5	RSGB 80-Meter Club Championship, CW	CW	RST, serial	<a href="http://www.rsgbcc.org/hf">www.rsgbcc.org/hf</a>
11 2300	15 2300	7, 14	AWA John Rollins Memorial DX Contest	CW	RST, equipment type and year	<a href="http://www.antiquewireless.org">www.antiquewireless.org</a>
14 0000	14 2359	3.5-28	YB DX RTTY Contest	Dig	RST, serial	<a href="http://rtty.ybdxcontest.com/dx-station-rules">rtty.ybdxcontest.com/dx-station-rules</a>
14 1000	15 1000	3.5-28	RSGB Commonwealth Contest	CW	RST, serial	<a href="http://www.rsgbcc.org/hf">www.rsgbcc.org/hf</a>
14 1200	15 1000	144, 432, 1296	SARL VHF/UHF Analogue Contest	CW Ph	RS(T), 6-char grid square	<a href="http://www.sarl.org.za">www.sarl.org.za</a>
14 1200	15 1200	3.5-144	F9AA Cup, SSB	Ph	RST, serial	<a href="http://www.site.urc.asso.fr">www.site.urc.asso.fr</a>
14 1200	15 1200	28	South America 10 Meter Contest	CW Ph	RS(T), CQ zone	<a href="http://sa10m.com.ar/cqsa10m_rules.html">sa10m.com.ar/cqsa10m_rules.html</a>
14 1400	14 2000	3.5-28	AGCW QRP Contest	CW	RST, serial, class, mbr or "NM"	<a href="http://agcw.org/index.php/en">agcw.org/index.php/en</a>
14 1500	15 1500	1.8	Stew Perry Topband Challenge	CW	4-char grid square	<a href="http://www.kkn.net/stew">www.kkn.net/stew</a>
14 1500	15 2100	3.5-50	Oklahoma QSO Party	CW Ph	RS(T), county or SPC	<a href="http://k5cm.com/okqp.htm">k5cm.com/okqp.htm</a>
14 1600	15 1600	3.5-28	EA PSK63 Contest	Dig	RSQ, EA province or serial	<a href="http://concurso.ure.es/en">concurso.ure.es/en</a>
14 1800	15 0559	3.5, 7	TESLA Memorial HF CW Contest	CW	RST, serial, 4-char grid square	<a href="http://radiosport.org.rs/HFTeslaMemorial">radiosport.org.rs/HFTeslaMemorial</a>
14 1800	15 1800	1.8-50	QCWA QSO Party	CW Ph Dig	Last 2 digits of year first licensed, name, SPC or QCWA chapter	<a href="http://qcwa.org/W2020-qso-party-rules.pdf">qcwa.org/W2020-qso-party-rules.pdf</a>
14 1900	15 1900	1.8-28	Idaho QSO Party	CW Ph	County or SPC	<a href="http://pocatelloarc.org/Idahoqsoparty">pocatelloarc.org/Idahoqsoparty</a>
14 2200	14 2300	1.8-28	QRP ARCI Spring Thaw SSB Shootout	Ph	RS, SPC, mbr or power	<a href="http://qrparki.org/contests">qrparki.org/contests</a>
15 0000	15 0400	3.5-14	North American Sprint, RTTY	Dig	Other station's call, your call, serial, name, SPC	<a href="http://ncjweb.com">ncjweb.com</a>
15 0700	15 1100	144	UBA Spring Contest, 2 Meter	CW Ph	RS(T), serial, UBA section (if UBA)	<a href="http://uba.be/hf/contest-rules">uba.be/hf/contest-rules</a>
15 1800	16 0100	All (no WARC)	Wisconsin QSO Party	CW Ph Dig	County or SPC	<a href="http://warac.org/wqp/wqp.htm">warac.org/wqp/wqp.htm</a>
16 0200	16 0400	1.8-28	Run for the Bacon QRP Contest	CW	RST, SPC, mbr or power	<a href="http://qrpcontest.com/pigrunyo3test201x.blogspot.ro/p/blog-page.html">qrpcontest.com/pigrunyo3test201x.blogspot.ro/p/blog-page.html</a>
16 1800	16 2059	3.5, 7	Bucharest Digital Contest	Dig	RST, serial	<a href="http://clarayl.ca/chatter-party">clarayl.ca/chatter-party</a>
17 1700	22 1700	3.5-28	CLARA Chatter Party	CW Ph	RS(T), name, SPC	<a href="http://clarayl.ca/chatter-party">clarayl.ca/chatter-party</a>
19 0030	19 0230	3.5-14	NAQCC CW Sprint	CW	RST, SPC, mbr or power	<a href="http://naqcc.info">naqcc.info</a>
21 0200	23 0200	3.5-28	BARTG HF RTTY Contest	Dig	RST, serial, 4-digit UTC time	<a href="http://www.bartg.org.uk">www.bartg.org.uk</a>
21 1200	22 1200	1.8-28	Russian DX Contest	CW Ph	RS(T), 2-char oblast or serial	<a href="http://rdxc.org/asp/pages/rulesg.asp">rdxc.org/asp/pages/rulesg.asp</a>
21 1400	21 1800	144, 432	AGCW VHF/UHF Contest	CW	RST, serial, power class, 6-char grid	<a href="http://agcw.org/index.php/en">agcw.org/index.php/en</a>
21 1400	22 2359	All (no WARC)	Virginia QSO Party	CW Ph Dig	Serial, VA county or SPC	<a href="http://qsl.net/sterling/VA_QSO_Party">qsl.net/sterling/VA_QSO_Party</a>
21 2000	21 2159	1.8-28	Feld Hell Sprint	Dig	RST, mbr, SPC, grid	<a href="http://sites.google.com/site/feldhellclub">sites.google.com/site/feldhellclub</a>
22 0700	22 1100	3.5	UBA Spring Contest, SSB	Ph	RS, serial, UBA section (if ON)	<a href="http://uba.be/hf/contest-rules">uba.be/hf/contest-rules</a>
25 0000	25 0200	1.8-28	SKCC Sprint	CW	RST, SPC, name, mbr or power	<a href="http://www.skccgroup.com">www.skccgroup.com</a>
25 2000	25 2100	3.5	UKEICC 80-Meter Contest	CW	4-char grid square	<a href="http://www.ukeicc.com">www.ukeicc.com</a>
26 2000	26 2130	3.5	RSGB 80-Meter Club Championship, SSB	Ph	RS, serial	<a href="http://www.rsgbcc.org/hf">www.rsgbcc.org/hf</a>
28 0000	28 2359	1.8-VHF	FOC QSO Party	CW	RST, name, mbr (if FOC member)	<a href="http://g4foc.org/qsoparty">g4foc.org/qsoparty</a>
28 0000	29 2359	1.8-28	CQ WW WPX Contest, SSB	Ph	RS, serial	<a href="http://www.cqwpw.com">www.cqwpw.com</a>
30 1300	31 0400	1.8-28	QCX Challenge	CW	RST, name, SPC, rig	<a href="http://qrp-labs.com/party.html">qrp-labs.com/party.html</a>

All dates refer to UTC and may be different from calendar date in North America. Times given as AM or PM are local times and dates. No contest activity occurs on the 60-, 30-, 17-, and 12-meter bands. Serial = Sequential number of the contact. S/P/C = State, Province, DXCC Entity. XE = Mexican state. Publication deadline for Contest Corral listings is the first day of the second month prior to publication date (May 1 for July QST) — send information to [contests@arrl.org](mailto:contests@arrl.org). Listings in blue indicate contests sponsored by ARRL or NCJ. The latest time for a valid contest QSO is the minute listed in the "Finish Time" column.

# The 2019 IARU HF World Championship Results

Over 4,500 stations from all over the world participated in this popular contest, held July 13 – 14, 2019.



Marcin, HB9EGA, set up his portable station at a farm near his home in Switzerland. He finished first place in the Phone Only, QRP, World category. [Marcin Korona, HB9EGA, photo]

### Full Results Online

You can read the full results of the contest online at [contests.arrl.org](http://contests.arrl.org) or [www.arrl.org/contest-results-articles](http://www.arrl.org/contest-results-articles). You'll find detailed analysis and more play-by-play, along with the full line scores. Improve your results by studying your log-checking report, too.

The next IARU HF World Championship will be held the second full weekend of July (July 11 – 12, 2020).

## 2019 IARU Special Station Scores

Scoring of IARU station logs provided by World Wide Radio Operators Foundation (WWROF).

### IARU Headquarters Stations

Call	Score
TM0HQ	23,129,114
DA0HQ	18,751,986
OL9HQ	17,230,271
IO0HQ	17,195,076
EF4HQ	16,753,338
GR2HQ	16,658,376
S50HQ	16,025,672
SN0HQ	15,984,168
9A0HQ	14,913,108
LY0HQ	13,306,860
YT0HQ	11,799,399
YR0HQ	11,413,800
SE9HQ	11,269,009
LZ0HQ	10,040,744
OE0HQ	9,563,624
OP0HQ	9,530,523
NU1AW	8,674,050
HB9HQ	7,729,605
R9HQ	7,647,178
OZ1HQ	7,249,871
YL4HQ	6,597,450
PA6HQ	3,863,808
Z30HQ	3,658,341
8N0HQ	3,455,650
OH2HQ	3,385,440
LU0HQ	2,534,035
B0HQ	2,037,328
LN2HQ	1,958,094
CR5HQ	1,743,248
ER7HQ	1,376,090
W1AW	1,370,565
E2HQ	1,213,900
PJ2HQ	1,163,700
VP9HQ	1,128,420
CB1HQ	1,114,800
EI0HQ	1,068,480
CX1AA	782,132
A47HQ	777,650
T40HQ	699,985
TC3HQ	611,160
LX8HQ	608,420
UN1HQ	450,260
VR2HK	277,514
Z60A	253,616
DX0HQ	199,422
OA4O	141,000
HL0HQ	140,022
V31HQ	124,320
ZL6HQ	122,786
AT1HQ	116,730
EM5HQ	95,787
BV0HQ	95,404
YM1KM	150

### IARU Administrative Council Stations

K1ZZ	2,403,393
G5W	2,298,785
LA2RR	1,612,416
VE6SH	86,152

### IARU R1

F4GKR/P	761,971
DJ3HW	486,096
IV3KKW	109,710

### IARU R2

YV5AM	1,415,458
KK1Z	1,170,606
VE3YV	25,428

### IARU R3

JA1CJP	129,846
YB0AZ	80,104
9M4CMA	168





## Special Event Stations

Working special event stations is an enjoyable way to help commemorate history. Many provide a special QSL card or certificate!

**Through Dec. 31, 0000Z – 2359Z, various call signs, various cities, IA.** Great River Amateur Radio Club. **Iowa State Parks On-the-Air Centennial Celebration.** All bands, all frequencies, as available. Certificate & QSL. IASPOTA-2020, c/o Great River Amateur Radio Club, P.O. Box 1384, Dubuque, IA 52004. *Members will operate with their own call signs from state parks throughout Iowa. Operating as time permits, mostly weekends. QSL for single contact; contact five parks for a certificate. See website for complete information.* [www.w0dbq.org/iaspota](http://www.w0dbq.org/iaspota)

**Feb. 1 – Feb. 29, 0001Z – 2359Z, I13BIA, Antholz, South Tyrol, Italy.** ARI Sektion Bruneck. **Biathlon World Championships 2020.** CW, SSB, and digital; 160, 80, 40, 20, 15, 10, 2 meters; 70 centimeters; 23 centimeters satellite Es'Hail 2 QO-100. QSL. Via bureau or direct to: ARI Sektion Bruneck, Montal 25, 39030 Bruneck/St. Lorenzen, Italy. [www.ari-bruneck.com](http://www.ari-bruneck.com)

**Feb. 29, 0000Z – 2359Z, WA4CZD, Sparta, TN. 2019 Rare Disease Day Special Event.** 14.246 7.246 7.115. QSL. Via bureau, LoTW, or direct to Jill Dybka, WA4CZD, 7737 Sparta Hwy., Sparta, TN 38583.

**Mar. 1, 1300Z – 2300Z, N0N, Lincoln, NE.** Southeast Nebraska Amateur Radio Club. **Nebraska Statehood Day.** 18.150 14.292 14.265 7.180. Certificate & QSL. Charles Bennett, KD0PTK, P.O. Box 67181, Lincoln, NE 68506. *We will be operating from the 14th floor of the State Capitol building. Clubs across Nebraska are encouraged to participate.* <https://www.facebook.com/SENRC>

**Mar. 5 – Mar. 12, 0000Z – 0000Z, W5S, Oklahoma City, OK.** Mid-Del Amateur Radio Club. **C-47 Skytrain.** 144.200 14.280 7.280. QSL. Mid-Del Amateur Radio Club, P.O. Box 30512, Midwest City, OK 73140. [www.w5mwc.org](http://www.w5mwc.org)

**Mar. 14, 1300Z – 1900Z, W1M, Russell, MA.** Western Mass Council — Scouting USA. **WHOA/SCOTA.** 14.290 14.060 7.190 7.030. QSL. Tom Barker, 329 Faraway Rd., Whitefield, NH 03598. *Paper logging is used; there will be a delay in sending out QSL cards.*

**Mar. 14, 1600Z – 2100Z, K7T, Tucson, AZ.** Oro Valley Amateur Radio Club. **Battle of Picacho Peak Anniversary.** CW 14.040 7.040; SSB 14.250; FT8 18.100. Certificate. Email [qsl@tucsonhamradio.org](mailto:qsl@tucsonhamradio.org) for certificate. *No paper QSLs please.* [www.tucsonhamradio.org](http://www.tucsonhamradio.org)

**Mar. 14, 1700Z – 2300Z, K9TAL, Indianapolis, IN.** The American Legion Amateur Radio Club. **The American Legion's 101st Birthday Celebration.** 14.275 7.225; \*CrossRds\* EchoLink Conference IRLP Reflector 9735. Certificate & QSL. The American Legion Amateur Radio Club, 700 N. Pennsylvania St., Indianapolis, IN 46204. [k9tal@legion.org](mailto:k9tal@legion.org) or [www.legion.org/hamradio](http://www.legion.org/hamradio)

**Mar. 14, 1700Z – 2359Z, N16IW, San Diego, CA.** USS Midway (CV-41) Museum Ship. **Launching of USS Midway.** 14.320 7.250 PSK31 14.070 DSTAR REF001C. QSL. USS Midway Museum Ship COMEDTRA, 910 N. Harbor Dr., San Diego, CA 92101.

**Mar. 14 – Mar. 15, 0500Z – 0500Z, N2RE, Princeton, NJ.** David Sarnoff Radio Club. **Pi Day March 14, 2020.** 14.250 14.050

7.120 7.050. QSL. Bob Uhrig, 104 Knoll Way, Rocky Hill, NJ 08553-1013. [www.qrz.com/db/n2re](http://www.qrz.com/db/n2re)

**Mar. 16 – Mar. 22, 0000Z – 2359Z, K1B/K1J/K1P/W1C/W1H/W1K/W1L/W1O/W1P/W1S/W1W/W1Y, various cities, ME.** Maine Bicentennial Special Event Group. **Maine Bicentennial Special Event.** HF, 6 and 2 meters; SSB, CW, and digital. Certificate. Tim Watson, KB1HNZ, P.O. Box 6833, Scarborough, ME 04074. *Certificate for contact; endorsements for bands, modes, and clean sweep of contact with each of the Maine 200 special event call signs.* [maine200specialevent.com](http://maine200specialevent.com)

**Mar. 20 – Mar. 31, 0000Z – 2359Z, N6A, Healdsburg, CA.** Will Pattullo, AE6YB. **Alcatraz Federal Penitentiary Anniversary of Closing.** 21.265 14.265 7.265 3.815. QSL. Will Pattullo, 161 Presidential Cir., Healdsburg, CA 95448. [www.qrz.com/db/ae6yb](http://www.qrz.com/db/ae6yb)

**Mar. 24 – Mar. 26, 1300Z – 2000Z, W4LX, Fort Myers, FL.** Fort Myers Amateur Radio Club. **The Buckingham Army Airfield.** 21.240 14.240. Certificate & QSL. Fort Myers Amateur Radio Club, P.O. Box 061183, Fort Myers, FL 33906. [www.fmarc.net](http://www.fmarc.net)

**Mar. 28, 1400Z – 2000Z, W4BKM, Macon, GA.** Macon Amateur Radio Club. **Cherry Blossom Special Event Station.** 14.240 7.225. Certificate. Macon Amateur Radio Club, P.O. Box 4682, Macon, GA 31208. [www.w4bkm.org](http://www.w4bkm.org)

**Mar. 29, 1400Z – 2100Z, N4H, Daviston, AL.** Lake Martin Amateur Radio Club. **Battle of Horseshoe Bend (Creek Indian War) Anniversary.** 14.250 7.280 3.850. Certificate & QSL. John Phillips, P.O. Box 938, Alexander City, AL 35011. [www.facebook.com/K4YWE/](http://www.facebook.com/K4YWE/) or [www.qrz.com/db/n4h](http://www.qrz.com/db/n4h)

**Certificates and QSL cards:** To obtain a certificate from any of the special event stations offering them, send your QSO information along with a 9 × 12-inch self-addressed, stamped envelope (three units of postage) to the address listed in the announcement. To receive a special event QSL card (when offered), be sure to include a self-addressed, stamped business envelope along with your QSL card and QSO information. \*Note: Some clubs may ask for a nominal fee to cover the cost of the certificate or QSL. Request will be made on air during the event or on the club's website.

**Special Events Announcements:** For items to be listed in this column, use the ARRL Special Events Listing Form at [www.arrl.org/special-events-application](http://www.arrl.org/special-events-application). A plain-text version of the form is available at that site. You may also request a copy by mail or email. Off-line completed forms can be mailed, faxed (Attn: Special Events), or emailed.

Submissions must be received by ARRL HQ no later than the 1st of the second month preceding the publication date; a special event listing for **June QST** would have to be received by **April 1**. In addition to being listed in *QST*, your event will be listed on the ARRL Web Special Events page. Note: All received events are acknowledged. If you do not receive an acknowledgement within a few days, please contact us. ARRL reserves the right to exclude events of a commercial or political nature.

You can view all received Special Events at [www.arrl.org/special-event-stations](http://www.arrl.org/special-event-stations).

## The World Above 50 MHz

# VHF Antennas and Geminids Activity



Figure 1 — Rick Dorsch's, NE8Z, setup while operating on 6 meters from Ecuador in fall 2019. [Rick Dorsch, NE8Z, photo]

Antennas for the 222 MHz band are straightforward and easier to manage, as they are smaller than on 144 MHz. The Yagi is the most popular design for weak-signal work. Vendors such as M2 and Directive Systems offer quality antennas. For the DIY enthusiast, design options include the WA5VJB Cheap Yagi (found at <https://www.wa5vjb.com/yagi-pdf/cheapyagi.pdf>) and the VE3CVG "Plumber's Delight" 222 MHz Yagi (found at <https://ve3cvg.webqth.com/antennas/222/index.html>). Another antenna to consider is the Quagi (found at [www.overbeck.com/quagi.htm](http://www.overbeck.com/quagi.htm)). I used a Quagi on 222 MHz for years. It is an effective and inexpensive antenna if one takes care during construction.

### HC1MD/2 6-Meter Activity from Ecuador

Rick Dorsch, NE8Z, says he operated the first week in November 2019 from the Capay on Hill Lighthouse in Ecuador (World Lighthouses on

the Air reference number WLOTA ECU-017). Rick recalled when he operated as HC1MD/5 on 6 meters working TEP in Solar Cycle 23 (see Figure 1). But he didn't have a 6-meter antenna. Rick improvised, saying:

I wandered down to the maintenance shed and had the worker scrounge up some material for me. We found an old PVC pipe. He made three insulators for me and drilled the necessary holes for an inverted-V antenna for 50 MHz. We found an old 20-foot scrap piece of #14 stranded wire. I didn't have solder or a soldering gun with me. I cut the wire to 50.200 MHz and then tightly wrapped the wire around the end of a PL-259 connector (I had a 25-foot length of RG8-X with PL-259s in my suitcase as a spare). I taped it really tight and then mounted the antenna my balcony hanging 30 meters from the cliff over the Pacific Ocean.

After setting up the antenna, Rick called one CQ on 50.313 MHz on FT8 on November 1, 2019 at 2158Z, running 50 W.

"My entire screen lit up orange!" Rick recalled as he began working through the pileup. From 2158Z – 2337Z, he made contacts with 12 stations. Rick says KD5M copied every CQ he sent that afternoon. "It was like we had a wire running between us." From 0001Z until 0020Z on November 2, Rick worked W5RWF (EM50), WD5BJT, AA5C (EM13), and W5TCX (EL29). Later that same day, from 2048Z until 2116Z, Rick "worked YS1MAE, TI5/N5BEK, and ZF1EJ." Rick felt the propagation mode was TEP.

Following the opening on DX Maps, I saw sporadic E present from the southeast states, Gulf Coast, and Texas to Central America. Ecuador is within double-hop sporadic-E range of these regions, and perhaps it was E<sub>s</sub>.

If the HC8GR/b had been operational, it may have let 6-meter DXers know if the Galapagos Islands were included in this unexpected opening.

## On the Bands

**50 MHz.** The Winter North America sporadic-E season started off with a bang on December 4, with a strong all-day opening across North America, extending to Central America and the Caribbean. E<sub>s</sub> first appeared from W5 and W8 at 1405Z, then spread across eastern North America. I made dozens of FT8 E<sub>s</sub> contacts to Alabama, Georgia, and Florida from EM28 around 1830Z. Later, I stopped on highway 177 south of Manhattan, Kansas (EM18), and set up fixed mobile. I used an MFJ-9406 at 10 W and ¼-wave magnet mount. I made seven FT8 contacts in Florida, Georgia, and Virginia. I was called by WA1EAZ (FN42) and decoded WU1ITU (FN65) on 2× E<sub>s</sub>. N0LL (EM09) decoded HH2AA. KW4BY in Florida also spotted some DX stations, including T15/N5BEK, XE1MEX, XE2AT, XE2JS, HI8DL, HI8PLE, KP4EIT, HI8RD, NP3XF, NP4BM, and LU5FF on E<sub>s</sub> – TEP. Roger, VE1SKY (FN74), made 19 contacts on sporadic E using FT8. The next day, he made 41 FT8 E<sub>s</sub> contacts in the southeast states.

Roger, VE1SKY, completed a Geminids MSK144 contact with W0VTT (EN33), and at 1406Z, Roger decoded W5LDA, working W4VAS.

They ran a schedule, and at 1432Z, W5LDA received a “R FN74” message from VE1SKY, but there was no completion. The distance was 2,776 kilometers.

Larry, N0LL, operated portable from rare grid EN20 during the Geminid meteor shower, running 60 W and a three-element Yagi. During the shower, Larry made 24 MSK144 contacts (including N0JK in EM28 at 1412Z on December 14). His best DX contact was with WA1EAZ (FN42) “on a blue whizzer.” Larry decoded

several stations on his mobile whip while driving to the operating site.

Bob, K6QXY, reports working A21NK (Paul, ZS6NK) on December 15 on JT65 EME for his 184th 6-meter DXCC contact at –27 dB.

On December 20, there was a North America-to-New Zealand opening. Gary, K9RX (EM84), in South Carolina, heard and then worked ZL4RV at 2159Z using JT65. A few minutes later, he added ZL4AS with a –13 dB report. There was E<sub>s</sub> present from the southeast states to Mexico as well as ZL stations, working XE1MEX at this time. XE1MEX reported working ZL3RC, ZL4RV, ZL3NW, and ZL2OK. Perhaps E<sub>s</sub> links from North America across afternoon TEP, then via E<sub>s</sub> to New Zealand. These were truly remarkable contacts at the solar minimum on 6 meters.

**144 MHz.** N0LL (EM09) worked K7ULS (DN41) on MSK144 on December 2 at 1434Z. KF0M (EM17) worked K0TPP (EM48) on tropo on December 7. WA9DU (EM69) logged VE1SKY (FN74) via MSK144 on December 9 at 1347Z. David commented:

The *WSJT* modes have truly altered the landscape on the ultra highs. Throw in the chat rooms and some of the other software... and the situation is way different. There has never been a better time to be active on VHF/UHF. The tools available today are so much better than in the past. While much has changed, the one thing that hasn't is that thrill of snagging a new one.

On December 26, Ray, W3BFC (FM28), worked KG4HJB (EL98) on tropo. W3BFC was using a single-loop antenna and 85 W on SSB. On December 28, Stan, W8MIL (EN74), found midday tropo to New Jersey and New York. He worked AA2UK, KC2TN (FM29), and K2KV (FN20), all on SSB.

**222 MHz.** Wyatt, AC0RA, and KG5CCI ran a grid expedition to Arkansas and Oklahoma on 222 MHz



**Figure 2** — Dave, KG5CCI, and Wyatt, AC0RA, on their 2019 Geminid meteor shower operation on 222 MHz from Arkansas and Oklahoma. [Wyatt Dirks, AC0RA, photo]

during the Geminids. They completed 15 contacts, 13 via MSK144 and two on FT8 (see Figure 2). The best DX contact was with K1OR (FN42). Charles, N0AKC (EN44), worked the pair in both states on MSK144. Oklahoma is his 20th state.

K7ULS (DN41) also got both rare states on MSK144. James, K7KQA (DN06), picked up W9RM (DM58) and N1AV (DM43) in the Geminids. He runs a seven-wave-long Yagi.

**432 MHz.** Bob, K2DRH (EN41), noted tropo associated with unseasonably warm weather in the Midwest on December 24/25. He worked Brad, WQ5S (EM13), from 1,145 kilometers and Al, W5LUA (EM13), using FT8.

## Here and There

Lance, W7GJ, and Gene, KB7Q, announced a joint 6- and 2-meter EME DXpedition to the Marquesas November 3 – 15, 2020, as TX7MB. For more information, visit [www.bigskyspaces.com/w7gj/Marquesas%202020.htm](http://www.bigskyspaces.com/w7gj/Marquesas%202020.htm).

According to [spaceweather.com](http://spaceweather.com) reports, more sunspots from Solar Cycle 25 are appearing on the first week of January. Unfortunately, this does not mean the solar minimum is ending. Low sunspot counts will continue for years. But Solar Cycle 25 is coming to life!

## How's DX?

# The WSJT-X Call 1st Setting

Al is a frequent traveler to the Pacific. In this month's column, he discusses his experience with WSJT-X's Call 1st setting during his recent operation as V63AR.

In this column, I'll explain the Call 1st setting in WSJT-X. I'll provide specific scenarios of use by covering three ways a DXpedition manages an FT8 pileup and the pros and cons of each method.

Figure 1 shows the Call 1st checkbox with the tooltip, "Check to call the first decoded responder to my CQ." While operating as V63AR, I worked stations three ways on FT8: Fox/Hound mode, Call 1st unchecked, and Call 1st checked.

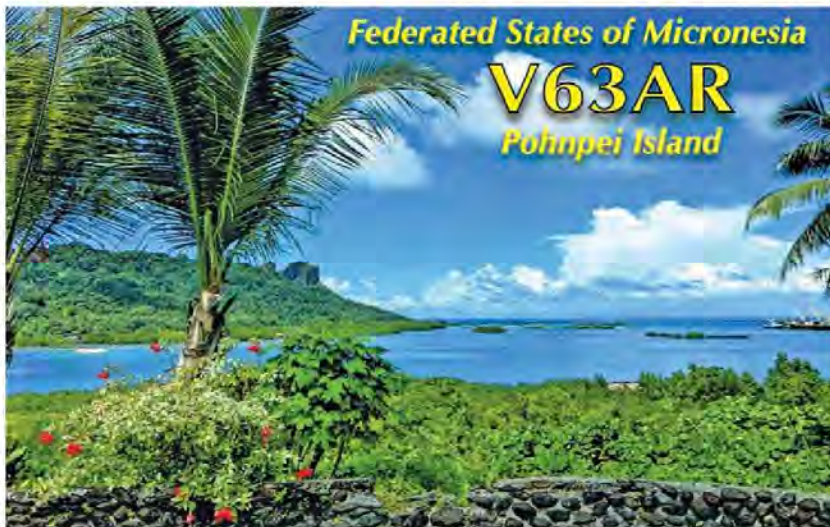

QSL cards from Al Rovner's, K7AR, 18 – 26, 2019 operation can be obtained via K7AR using Club Log's Online QSL Request System (OQRS) for both direct or bureau requests.

### Fox/Hound Mode

When calling CQ on a standard FT8 frequency, usually within a few minutes the pileup becomes large enough to warrant using Fox/Hound mode. Fox/Hound mode allows all stations calling the expedition to have the chance for a contact as long as the DX operator places stations in the Fox queue in the order they are received. Each station in the queue bubbles to the top as other stations are worked, and has three opportunities to complete a contact. If a contact cannot be completed, the station is dropped from the queue, making room for other stations.

### Call 1st Unchecked

Sometimes a band isn't open or there are not enough callers to warrant using Fox/Hound mode. In this case, I would call CQ on a standard FT8 frequency, and manually pick stations to reply to from the list of decoded stations. As I have operated

from the Pacific for the last 6 years, I've found that stations from Asia are booming on all bands. While it's easy to have contacts with Japan (JA), China (BY), South Korea (HL), Asiatic Russia (UA0), and other Asian stations, sometimes I'll manually select those with a more difficult path to the Pacific, such as the US East Coast, western European Union, or southern Africa. My location at V63AR is almost 10,000 miles from South Africa (ZS), so it was a plea-

sure to have contacts with those stations. It's really up to the DX operator on how to handle this situation.

### Call 1st Checked

A real-world example of a checked Call 1st box is shown in Figure 2. Just below the first yellow line in the figure, YC2WXV is calling on 488 Hz, and is the lowest frequency calling. Therefore, it meets the Call 1st criteria as a completed contact.



Figure 1 — The Call 1st checkbox tooltip.



The fact that Call 1st responds automatically to stations on lower frequencies first makes it challenging for stations calling at higher frequencies to make contacts. There are two ways to handle this.

For the first method, see Figure 2. Notice JI2FBG at 606 Hz below the second yellow line. That is not present in the previous section with red decoded signals. By calling at 606 Hz, this station jumped ahead of other callers, becoming the next contact made.

The second method is to call on the DX station's frequency. In the case of Figure 2, that would be 1060 Hz. This allows a station to immediately get through to the DX station, bypassing Call 1st. However, if five stations call on 1060 Hz, it's possible for no one to be decoded. In fact, most FT8 operators are taught to avoid calling on the DX station's frequency.



Figure 2 — An example of several stations calling V63AR, ordered by frequency.

Now, I'm not necessarily saying you should start calling DX stations at 300 Hz or lower to be first on the decoded list, but this can be a tricky situation. From your home station, you have no way to know whether a DX station is using the Call 1st mode. In Figure 2, all stations are nicely lined up on different frequencies, hoping for a contact.

### Finding the Right Fit

I suggest implementing a Call Random mode. This would give all callers an opportunity to have a contact, regardless of what frequency they use. Call Random would randomly choose a station from the list of decoded signals and proceed with a contact.

While my comments are from the perspective of a DXpedition operator, they also apply to home stations. Next time you call CQ on FT8, consider how Call 1st mode works, and whether it's right for you.

All photos by the author.

## The April 2020 ARRL Rookie Roundup — Phone

1800 UTC – 2359 UTC, Sunday, April 19

The Rookie Roundup is an event to encourage newly licensed operators to get on the HF bands and experience competitive amateur radio. This is a great way for clubs to get their newer members on the air, and the perfect opportunity to mentor new licensees.

Rookies will attempt to make as many contacts as possible during this 6-hour event. Rookies work everyone and non-Rookies work only Rookies. If you were first licensed in 2020, 2019, or 2018, you can enter as a Rookie.

Rookie entries are limited to operators who have either:

- ♦ Made no contacts at all or have made their first amateur radio contact during 2020, 2019, or 2018;
- ♦ Or, for this event, who have never made any contacts on the phone contest mode



Participants in the Rookie Roundup can receive certificates to proudly display their achievements. Results and certificates will be available at [contests.arrl.org](http://contests.arrl.org).

before the Rookie Roundup contest. Operators may enter in this category only once and must send the current year in their exchange.

Rookies can enter as Single Operators or invite Rookie friends over and operate as Multioperator. Up to five Single Operator Rookies can also enter from their individual stations and submit their total score as a team.

The exchange is your name, the last two numbers of the year you were licensed, and your state, province, or "DX" if you're outside of the US and Canada.

Non-Rookies, join the fun by calling "CQ Rookies," to encourage the Rookie operators to flock to you.

All scores must be reported within 72 hours after the event. No late entries will be accepted.

Complete rules, log sheets, and links for submitting your score can be found at [www.arrl.org/rookie-roundup](http://www.arrl.org/rookie-roundup).

Complete rules can be found at [www.arrl.org/rookie-roundup](http://www.arrl.org/rookie-roundup)

# Certificate of Code Proficiency

## Recipients

Sponsored by **VIBROPLEX**  
www.vibroplex.com



This month, ARRL and Vibroplex recognize merit and progress in Morse code proficiency on the part of the following individuals, who have achieved proficiency at the following rates, in words per minute.

### November 2019

David A. Bamford, W2DAB	10
Michael J. Erskine, W4MHZ	10
Mark G. Feuerstein, N7MMO	10
John F. Johnson, N8JFJ	10
Michael W. Geoghegan, KX6A	10
Donald E. Kirby, KR3A	10
William A. Miller, W6QA	10
James D. Russ, AB4KA	10
Warren T. Seeley, W4FLL	10
Richard P. West, KH2EE	10
Stephen P. White, KL3MM	10
David J. Wise, KD6EOD	10
Frank P. Arciuolo, W1ZAH	15
Keith Austermler, KB9STR	15
Michael J. Erskine, W4MHZ	15
Paul W. Peterson, K1HIS	15
John F. Wasciuk, WA8TON	15
Stephen M. Zappe, WA3GQA	15
Joe P. Bratton, AA5AD	20
Raymond T. Henderson, WA3PRR	20

Michael Terry Jones, W4TL	20
Roy S. Ludwig, KN4WOJ	20
Stephen J. Mlecik, K1NA	20
Akihiro Akai, JQ2UOZ	25
Donald J. Backys, K9UQN	25
Michael Terry Jones, W4TL	25

### December 2019

Thomas P. Baxter, W9TPB	10
Benjamin M. Cahill, III, AC2YD	10
James T. Griffin, N4JG	10
Martin Hickey, AJ6CL	10
Steve M. Kuzyszyn, KB2WQ	10
Willis S. Stricklin, K0SMK	10
Gerald E. Trimble, Jr., KG8HZ	10
Paul Leon Castonguay, KC1LBL	15
Cesidio DiBenedetto, Jr., KD8OOB	15
Steven G. Fein, KM6VOV	15
Paul A. Miller, W5RES	15
Dennis J. Niles, WV7S	15
Gregory L. Rix, WB7GR	15

Stanford H. Rowe, K6VVE	15
Otto P. Altobelli, K2BY	20
Thomas H. Beebe, W9RY	20
Robert S. Boles, WB4SED	20
Lynn R. Landin, WB0U	20
Dennis M. Markell, N1IMW	20
David J. O'Farrell, WB0IXV	20
Harold E. Fox, K7SAX	30
Gilbert D. Woodside, III, WA1LAD	35
Richard T. Boswell, II, K4CUE	40

### January 2020

John M. Dziedzicko, W9QP	10
Marlo Montanaro, KA2IRQ	10
Warren D. Zimmer, KC7ND	10
Scott J. Bertrand, A14TT	15
Ishan Kumaraswami, AC2MX	15
James D. Russ, AB4KA	15
David W. Rice, AD8WR	20
Carl W. Davis, W8WZ	25

Congratulations to all the recipients.

## March 2020 W1AW Qualifying Runs

W1AW, the Hiram Percy Maxim Memorial Station at ARRL Headquarters in Newington, Connecticut, transmits Morse code Qualifying Runs to assist ham radio operators in increasing and perfecting their proficiency in Morse code. Amateur radio operators can earn a Certificate of Code Proficiency or endorsements by listening to W1AW Qualifying Runs.

March Qualifying Runs will be transmitted by W1AW in Newington, Connecticut at the times shown at 1.802.5, 3.581.5, 7.047.5, 14.047.5, 18.097.5, 21.067.5, 28.067.5, 50.350, and 147.555 MHz. The West Coast Qualifying Runs will be transmitted by K6KPH on Saturday, March 21 at 2 PM PDT (2100 UTC) on 3581.5, 7047.5, 14047.5, and 18097.5 kHz. Unless indicated otherwise, sending speeds are from 10 to 35 WPM.

Amateur radio operators who participate in Qualifying Runs may submit proof of 1 minute of the highest speed they have copied in the hope of qualifying for the Certificate of Code Proficiency, or an endorsement to their existing Certificate.

Legibly copy at least 1 minute of text by hand, and mail the sheet to: W1AW Qualifying Runs, 225 Main St., Newington, CT USA 06111.

Include \$10 (check or money order) if this is a submission for your initial Code Proficiency certificate; \$7.50 if you are applying for an endorsement (available for speeds up to 40 WPM). Your test will be

checked against the actual transmissions to determine if you have qualified.

For more information about Qualifying Runs, please visit [www.arrl.org/qualifying-run-schedule](http://www.arrl.org/qualifying-run-schedule).

For information about how to qualify for the Certificate of Code Proficiency, please visit [www.arrl.org/code-proficiency-certificate](http://www.arrl.org/code-proficiency-certificate).



### W1AW Code Proficiency Schedule — March 2020

(All times in Eastern Daylight Time, unless otherwise noted.)

Monday	Tuesday	Wednesday	Thursday	Friday
3/2 4 PM – 2100Z EST 10 – 35 WPM	3/3 7 PM – 0000Z EST (3/4 – UTC) 35 – 10 WPM		3/5 10 PM – 0300Z EST (3/6 – UTC) 10 – 40 WPM	3/6 9 AM – 1400Z EST 10 – 35 WPM
	3/10 4 PM – 2000Z 10 – 35 WPM	3/11 7 PM – 2300Z 10 – 40 WPM	3/12 9 AM – 1300Z 35 – 10 WPM	3/13 10 PM – 0200Z (3/14 – UTC) 10 – 35 WPM
	3/17 9 AM – 1300Z 10 – 35 WPM	3/18 10 PM – 0200Z (3/19 – UTC) 35 – 10 WPM	3/19 7 PM – 2300Z 10 – 35 WPM	3/20 4 PM – 2000Z 10 – 40 WPM
3/23 10 PM – 0200Z (3/24 – UTC) 10 – 40 WPM		3/25 9 AM – 1300Z 35 – 10 WPM	3/26 4 PM – 2000Z 35 – 10 WPM	3/27 7 PM – 2300Z 10 – 35 WPM

# Convention and Hamfest Calendar

## Abbreviations

*Spr* = Sponsor  
*TI* = Talk-in frequency  
*Adm* = Admission

### Alabama (Fort Payne) — Mar. 28 **DFHRTV**

8 AM – noon. *Spr*: Dekalb County ARC. Dekalb County VFW Fairgrounds, 151 18th St NE. *TI*: 147.27 (100 Hz). *Adm*: \$5. [www.w4gbr.org](http://www.w4gbr.org)

### Arizona (Scottsdale) — Mar. 21 **DFHRTV**

6 AM – noon. *Spr*: ARCA and Scottsdale ARC. Mountain Valley Community Church, 17700 N. Perimeter Dr. *TI*: 147.18 (162.2 Hz). *Adm*: \$5. [www.scottsdalearc.org](http://www.scottsdalearc.org)

### Arkansas (Fort Smith) — Apr. 4 **DFHQRV**

8 AM. *Spr*: Fort Smith Area ARC. Sebastian County Emergency Storm Shelter, Ben Geren Park, 7070 S. Zero St. *TI*: 146.64 (88.5 Hz). *Adm*: \$5. [www.fsaarc.org](http://www.fsaarc.org)

### California (Loomis) — Mar. 21 **DFHQRTS**

7 AM – noon. *Spr*: Sierra Foothills ARC. Historic Loomis Train Depot Plaza, 5775 Horseshoe Bar Rd. *TI*: 145.43 (162.2 Hz). *Adm*: Free. [www.w6ek.org](http://www.w6ek.org)

### Colorado (Longmont) — Apr. 4 **DFHRSV**

8 AM – 2 PM. *Spr*: Longmont ARC. Boulder County Fairgrounds Exhibit Building, 9595 Nelson Rd. *TI*: 147.27 (100 Hz). *Adm*: \$5, age 16 and younger free admission. [www.w0eno.org](http://www.w0eno.org)

### Connecticut (Southington) — Mar. 29 **DFHRSV**

8 AM – noon. *Spr*: Southington ARC. Southington High School, 720 Pleasant St. *TI*: 147.345, –444.2 (–151.4 Hz). *Adm*: \$5. [www.chetbacon.com/sara.htm](http://www.chetbacon.com/sara.htm)

### Florida (Coral Gables) — Mar. 14 **FT**

7 AM – noon. *Spr*: Flamingo Net ARC. University of Miami (UM) Parking Lot 1-109, 1300 Campo Sano Ave. *TI*: 147.15 +600 (94.8 Hz). *Adm*: Free admission, UM parking fee \$1.50/hr. [www.flamingonet.8m.net](http://www.flamingonet.8m.net)

### Florida (Fort Walton Beach) — Mar. 20 – 21 **DFHQSV**

Friday 4 – 8 PM, Saturday 8 AM – 2 PM. *Spr*: Playground ARC. C.H. "Bull" Rigdon Fairgrounds, 1958 Lewis Turner Blvd. *TI*: 146.79 (100 Hz). *Adm*: \$7. [www.w4zbb.org](http://www.w4zbb.org)

### Florida (New Port Richey) — Mar. 14 **FTV**

8 AM – noon. *Spr*: Gulf Coast ARC. Millennium Academy, 10005 Ridge Rd. *TI*: 146.67 (146.2 Hz). *Adm*: \$5. [www.gulfcoastarc.org](http://www.gulfcoastarc.org)

### Florida (Sarasota) — Mar. 28 **DFHRTS**

7 AM – noon. *Spr*: Sarasota Emergency RC. American Red Cross Campus, 2001 Cantu Ct. *TI*: 146.73 (100 Hz). *Adm*: \$2. [www.n4ser.org](http://www.n4ser.org)

### Florida (Stuart) — Mar. 21 **DFHRTV**

8 AM – 3 PM. *Spr*: Martin County ARA. Martin County Fairgrounds, 2616 SE Dixie Hwy. *TI*: 147.06. *Adm*: Free.

### Indiana (Brazil) — Mar. 15 **DFHR**

8 AM – noon. *Spr*: Wabash Valley ARA. Clay County Fairgrounds, 6550 N. State Rd. 59. *TI*: 146.685 (151.4 Hz). *Adm*: \$7. [www.w9uuu.org](http://www.w9uuu.org)

### Iowa (Oskaloosa) — Mar. 21 **DFHR**

8 – 11:30 AM. *Spr*: Mahaska ARC. American Legion Hall, 302 High Ave. E. *TI*: 145.49 – 600 (146.2 Hz). *Adm*: Donations accepted.

## LOUISIANA STATE CONVENTION

March 13 – 14, Rayne, LA

**DFHRTV**

Friday 3 – 8 PM, Saturday 8 AM – 3 PM. *Spr*: Acadiana ARA. Rayne Civic Center, 210 Frog Festival Dr. *TI*: 146.82 – 600 (103.5 Hz) *Adm*: Advance \$5, door \$8. [www.w5ddl.org/hamfest.htm](http://www.w5ddl.org/hamfest.htm)

### Minnesota (Buffalo) — Mar. 21 **HQRV**

8 AM – 1 PM. *Spr*: Maple Grove RC. Buffalo Civic Center, 1306 County Rd. 134 NE. *TI*: 147.0 (114.8 Hz). *Adm*: \$10. [www.k0ltc.org](http://www.k0ltc.org)

### Missouri (Boonville) — Mar. 21 **DFHR**

8 AM – 3 PM. *Spr*: Boonville ARC. Cooper County Youth Fairgrounds, 16899 Dunkles Dr. *TI*: 147.36 (127.3 Hz). *Adm*: \$3. [www.w0brc.org](http://www.w0brc.org)

## OZARKCON QRP CONFERENCE

April 3 – 4, Branson, MO

**HR S**

Friday noon – 8 PM, Saturday 9 AM – 5 PM. *Spr*: Four State QRP Group. Stone Castle Hotel and Conference Center, 3050 Green Mountain Dr. *Adm*: Advance \$12, door \$15. [www.ozarkcon.com](http://www.ozarkcon.com)

### Missouri (Mt. Vernon) — Mar. 28 **DFHRSV**

8 AM – 1 PM. *Spr*: Ozarks ARS. Mt. Vernon Arts and Recreation Center, 822 W. Mt. Vernon Blvd. *TI*: 146.97 (162.5 Hz). *Adm*: Advanced \$5, door \$8. [www.w0oar.com/annual-oars-hamfest/](http://www.w0oar.com/annual-oars-hamfest/)

### Nebraska (Lincoln) — Mar. 14 **DFHRSV**

8 AM – 3 PM. *Spr*: Lincoln ARC. Lancaster Event Center, 4100 N. 84th St. *TI*: 146.76. *Adm*: \$8, LARC members \$5. [www.lincolnhamfest.org](http://www.lincolnhamfest.org)

### New Hampshire (Hampton) — Apr. 4 **DFHRTV**

8 AM – noon. *Spr*: Port City ARC. St. James Masonic Lodge, 77 Tide Mill Rd. *TI*: 145.15 (127.3 Hz). *Adm*: \$5. [www.w1wqm.org](http://www.w1wqm.org)

### New Hampshire (Henniker) — Mar. 22 **DFHRSV**

8 AM – 2 PM. *Spr*: Contoocook Valley RC. Henniker Community School, 51 Western Ave. *TI*: 146.895 (100 Hz). *Adm*: \$3. [www.k1bke.org](http://www.k1bke.org)

### New Jersey (Clinton) — Mar. 14 **DFHRSV**

8 AM. *Spr*: Cherryville Repeater Association. N. Hunterdon Regional High School, 1445 Rt. 31. *TI*: 147.375 +.6 (151.4 Hz). *Adm*: \$5. [www.qsl.net/w2cra](http://www.qsl.net/w2cra)

### New Jersey (Parsippany) — Mar. 28 **DFHR**

8 AM – noon. *Spr*: New Jersey Antique RC. Parsippany PAL Building, 33 Baldwin Rd. *TI*: No talk-in frequency. *Adm*: \$5.

### New York (Norwich) — Apr. 4 **DFHRTV**

7 AM – noon. *Spr*: Chenango Valley ARA. Chenango County Pomona Grange, 167 County Rd. 32A. *TI*: 146.685 (110.9 Hz). *Adm*: \$5. [www.cvara.net/events](http://www.cvara.net/events)

**A** = AUCTION

**D** = DEALERS / VENDORS

**F** = FLEA MARKET

**H** = HANDICAP ACCESS

**Q** = FIELD CHECKING OF QSL CARDS

**R** = REFRESHMENTS

**S** = SEMINARS / PRESENTATIONS

**T** = TAILGATING

**V** = VE SESSIONS

## NORTH CAROLINA SECTION CONVENTION

March 13 – 14, Concord, NC

DFHQRSV

Friday 3 – 7 PM, Saturday 8:30 AM – 3 PM. *Spr:* Mecklenburg ARS. Cabarrus Arena & Events Center, 4551 Old Airport Rd. *Tl:* 146.655–600. *Adm:* Advance \$9, door \$10.

[www.charlottehamfest.org](http://www.charlottehamfest.org)

Ohio (Gallipolis) — Mar. 21 DFHRTV

8 AM – noon. *Spr:* Mid-Ohio Valley ARC. Gallia County Senior Citizens Center, 1165 State Rte. 160. *Tl:* 147.06 (74.4 Hz).

*Adm:* \$5. <http://sites.google.com/site/midohiovalleyarc>

## GREAT LAKES DIVISION CONVENTION

March 14 – 15, Perrysburg, OH

DFHRV

8 AM. *Spr:* Toledo Mobile Radio Assn. Owens Community College, 30335 Oregon Rd. TMRA Hamfest & Computer Fair. *Tl:* 147.27 (103.5 Hz). *Adm:* \$8. [www.tmrhamradio.org](http://www.tmrhamradio.org)

Pennsylvania (McKeesport) — Mar. 29 DFHQRSV

8 AM – 2 PM. *Spr:* Two Rivers ARC. McKeesport Palisades, 100 5th Ave. *Tl:* 146.73. *Adm:* Advanced \$5, door \$7.

Pennsylvania (Youngsville) — Mar. 14 DFHQRV

7 AM – 1 PM. *Spr:* BSA Venturing Crew 73. Youngsville Volunteer Fire Dept., 222 E. Main St. *Tl:* 147.015 (186.2 Hz). *Adm:* \$5.

Tennessee (Sevierville) — Mar. 28 DFHQIRSTV

8 AM – 4 PM. *Spr:* Sevier County ARS. Sevier County Fairgrounds, 754 Old Knoxville Hwy. *Tl:* 146.94. *Adm:* \$5.

[www.seviercountyars.org](http://www.seviercountyars.org)

Tennessee (Tullahoma) — Mar. 14 DFHRSTV

8 AM – 2 PM. *Spr:* Middle TN ARS. First United Methodist Church, 208 W. Lauderdale St. *Tl:* 146.7–600 (114.8 Hz).

*Adm:* \$5. [www.qsl.net/mtars](http://www.qsl.net/mtars)

Tennessee (Union City) — Mar. 28 DFHQIRSTV

8 AM – 1 PM. *Spr:* Reelfoot ARC. National Guard Armory, 2017 E. Reelfoot Ave. *Tl:* 146.8 (100 Hz). *Adm:* \$8.

[www.reelfootarc.com](http://www.reelfootarc.com)

## VERMONT STATE CONVENTION

February 22, Colchester, VT

DFHQSV

8 AM – 2 PM. *Spr:* Radio Amateurs of Northern Vermont. Hampton Inn, 42 Lower Mountain Rd. *Tl:* 145.15 (100 Hz). HAM-CON. *Adm:* Advance \$6, door \$9. [www.ranv.org/hamcon.html](http://www.ranv.org/hamcon.html)

## WEST TEXAS SECTION CONVENTION

March 21, Midland, TX

DFHQRSV

8 AM – 4 PM. *Spr:* Midland ARC. MLK Community Center, 2300 Butternut Ln. St. Patrick's Day Hamfest. *Tl:* 147.3 (88.5 Hz).

*Adm:* Free. [www.hamfest.w5qgg.org](http://www.hamfest.w5qgg.org)

## WEST VIRGINIA SECTION CONVENTION

March 12, Charleston, WV

DFHQRSV

9 AM – 2 PM. *Spr:* Charleston Hamfest Committee. Charleston Coliseum & Convention Center, 200 Civic Center Dr.

Charleston Hamfest. *Tl:* 145.35 (91.5 Hz). *Adm:* \$8.

[www.chaswvhamfest.com](http://www.chaswvhamfest.com)

Wisconsin (Jefferson) — Mar. 15 DFHQRV

8 AM – noon. *Spr:* Jefferson County ARES. Jefferson County Fairgrounds Activity Center, 503 N. Jackson Ave. *Tl:* 145.49 (123 Hz). *Adm:* \$7. [www.w9mqb.com](http://www.w9mqb.com)

Wisconsin (Milwaukee) — Apr. 4 FHR

8 AM – noon. *Spr:* Milwaukee RAC, Milwaukee Area ARS. Elks Lodge #46, 5555 W. Good Hope Rd. *Tl:* 145.13, 145.39 (127.3 Hz). *Adm:* Advance \$4, door \$5.

[www.w9rh.org/club-events/swapfest](http://www.w9rh.org/club-events/swapfest)

### To All Event Sponsors

Before making a final decision on a date for your event, you are encouraged to check the Hamfest and Convention Database ([www.arrl.org/hamfests-and-conventions-calendar](http://www.arrl.org/hamfests-and-conventions-calendar)) for events that may already be scheduled in your area on that date. You are also encouraged to register your event with HQ as far in advance as your planning permits. See [www.arrl.org/hamfest-convention-application](http://www.arrl.org/hamfest-convention-application) for an online registration form. Dates may be recorded up to 2 years in advance.

The deadline for receipt of items for this column is the **1st of the second month preceding publication date**. For example, your information must arrive at HQ by **April 1** to be listed in the **June** issue. Information in this column is accurate as of our deadline; contact the sponsor or check the sponsor's website for possible late changes, driving directions, and other event details. Please note that postal regulations prohibit mention in *QST* of games of chance, such as raffles or bingo.

## New Books

### Global Radio Guide, 13th Edition

Teak Publishing has announced the release of the 13th edition of the *Global Radio Guide* (Winter 2019 – 2020 edition) by Gayle Van Horn, W4GVH.

At the heart of this electronic publication is a 24-hour station/frequency guide with all the latest winter 2019 – 2020 schedules for selected AM broadcast, longwave, and shortwave radio stations. There are listings of DX radio programs and internet website addresses for many of the stations. There are also entries for time and frequency stations and other intriguing shortwave radio stations.

The *Global Radio Guide* is available for \$8.99 on **Amazon.com** as an e-book that can be viewed on any smartphone, tablet, or computer using free software (regardless of the operating system), or on any Amazon Kindle reader.



## Feedback

■ In the article “An SWR-Shifting T” by Bill Conwell, K2PO, published in the February issue of *QST*, it should be noted that depending on the transmit power and capacitance value needed, there can be high circulating currents in the capacitor. The CDE catalog lists mica capacitor series and their continuous current versus capacitance value and frequency. Lower current capacitors can also be paralleled to increase the current rating.

# W1AW Schedule

PAC	MTN	CENT	EAST	UTC	MON	TUE	WED	THU	FRI
6 AM	7 AM	8 AM	9 AM	1300		FAST CODE	SLOW CODE	FAST CODE	SLOW CODE
7 AM-1 PM	8 AM-2 PM	9 AM-3 PM	10 AM-4 PM	1400-1600 1700-1945	VISITING OPERATOR TIME (12 PM-1 PM CLOSED FOR LUNCH)				
1 PM	2 PM	3 PM	4 PM	2000	FAST CODE	SLOW CODE	FAST CODE	SLOW CODE	FAST CODE
2 PM	3 PM	4 PM	5 PM	2100	CODE BULLETIN				
3 PM	4 PM	5 PM	6 PM	2200	DIGITAL BULLETIN				
4 PM	5 PM	6 PM	7 PM	2300	SLOW CODE	FAST CODE	SLOW CODE	FAST CODE	SLOW CODE
5 PM	6 PM	7 PM	8 PM	0000	CODE BULLETIN				
6 PM	7 PM	8 PM	9 PM	0100	DIGITAL BULLETIN				
6 <sup>45</sup> PM	7 <sup>45</sup> PM	8 <sup>45</sup> PM	9 <sup>45</sup> PM	0145	VOICE BULLETIN				
7 PM	8 PM	9 PM	10 PM	0200	FAST CODE	SLOW CODE	FAST CODE	SLOW CODE	FAST CODE
8 PM	9 PM	10 PM	11 PM	0300	CODE BULLETIN				

W1AW's schedule is at the same local time throughout the year. From the second Sunday in March to the first Sunday in November, UTC = Eastern US time + 4 hours. For the rest of the year, UTC = Eastern US time + 5 hours.

♦ Morse code transmissions: Frequencies are 1.8025, 3.5815, 7.0475, 14.0475, 18.0975, 21.0675, 28.0675, 50.350, and 147.555 MHz.

Slow Code = practice sent at 5, 7½, 10, 13, and 15 WPM.

Fast Code = practice sent at 35, 30, 25, 20, 15, 13, and 10 WPM.

Code bulletins are sent at 18 WPM.

For more information, visit us at

[www.arri.org/w1aw](http://www.arri.org/w1aw)

♦ W1AW Qualifying Runs are sent on the same frequencies as the Morse code transmissions. West Coast qualifying runs are transmitted by various West Coast stations on CW frequencies that are normally used by W1AW, in addition to 3590 kHz, at various times. Underline 1 minute of the highest speed you copied, certify that your copy was made without aid, and send it to ARRL for grading. Please include your name, call sign (if any), and complete mailing address. Fees: \$10 for a certificate, \$7.50 for endorsements.

♦ Digital transmissions: Frequencies are 3.5975, 7.095, 14.095, 18.1025, 21.095, 28.095, 50.350, and 147.555 MHz.

Bulletins are sent using 45.45-baud Baudot, PSK31 in BPSK mode, and MFSK16 on a daily revolving schedule.

Keplerian elements for many amateur satellites will be sent on the regular digital frequencies on Tuesdays and Fridays at 6:30 PM Eastern time using Baudot and PSK31.

♦ Voice transmissions: Frequencies are 1.855, 3.99, 7.29, 14.29, 18.16, 21.39, 28.59, 50.350, and 147.555 MHz. Voice transmissions on 7.290 MHz are in AM double sideband, full carrier.

♦ Notes: On Fridays, UTC, a DX bulletin replaces the regular bulletins. W1AW is open to visitors 10 AM to noon and 1 PM to 3:45 PM Monday through Friday. FCC-licensed amateurs may operate the station during that time. Be sure to bring your current FCC amateur license or a photocopy. In a communication emergency, monitor W1AW for special bulletins as follows: voice on the hour, teleprinter at 15 minutes past the hour, and CW on the half hour.

W1AW code practice and CW/digital/phone bulletin transmission audio is also available real-time via the *EchoLink Conference Server* W1AWBDCT. The conference server runs concurrently with the regularly scheduled station transmissions. The W1AW Qualifying Run texts can also be copied via the EchoLink Conference Server.

During 2020, Headquarters and W1AW are closed on New Year's Day, Presidents Day (February 17), Memorial Day (May 25), Independence Day (July 4), Labor Day (September 7), Veterans Day (November 11), Thanksgiving and the following day (November 26 and 27), and Christmas (December 25).

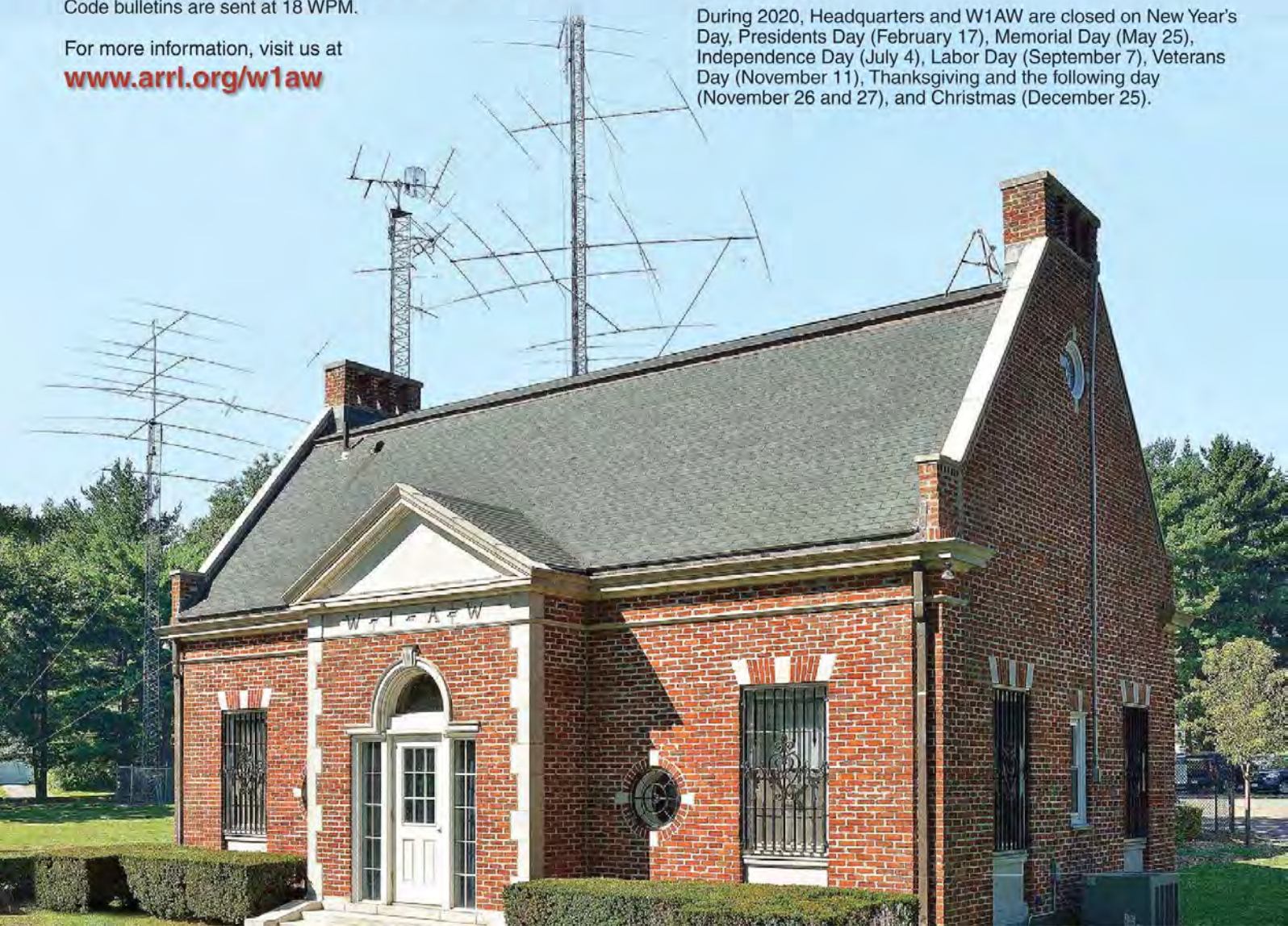

# ARRL VEC Volunteer Examiner Honor Roll



The ARRL VEC Honor Roll recognizes the top five Volunteer Examiners in each ARRL Division according to the total number of ARRL exam sessions in which they have participated since their accreditations. Considering each session requires an average time commitment of 2 to 4 hours or more, the thousands of hours these VEs have invested represent extraordinary dedication! Whether you are one of our VE Teams that tests once a week, once a month, or once a year, we want to express our warmest appreciation to all volunteers for your generous contribution to the ARRL VEC program.

If you are an ARRL VE, you can view your session stats online at [www.arrl.org/ve-session-counts](http://www.arrl.org/ve-session-counts).  
If you are not a VE, become one today! See [www.arrl.org/become-an-arrl-ve](http://www.arrl.org/become-an-arrl-ve).

Examiner	Sessions	Accreditation Date	Examiner	Sessions	Accreditation Date	Examiner	Sessions	Accreditation Date
<b>Atlanta</b>			<b>Hudson</b>			<b>Roanoke</b>		
Jobst Vandrey, AC0LP	323	23-Jun-08	Paul Maytan, AC2T	651	06-Sep-84	Judy Friel, AC4RG	282	01-Feb-91
James McCloskey, NS3K	318	14-Nov-94	Stanley Rothman, WA2NRV	450	01-Mar-85	Alan Ronald Moeck, WA2RPX	263	27-Sep-94
Edward Genoino, WA2NDA	298	10-Jul-85	E. Drew Moore, W2OU	437	01-Aug-90	David Snyder, W4SAR	246	01-May-93
George Brechmann, N3HBT	278	01-Apr-91	Fritz Boigris, KB2O	410	26-Oct-84	Sheila Frank, KT4YW	221	30-Oct-96
Robert Benna, N3LWP	230	21-May-97	Gerald Miller, Jr., AA2ZJ	399	05-Dec-95	Terry Sanner, WV8V	213	06-Sep-84
<b>Central</b>			<b>Midwest</b>			<b>Rocky Mountain</b>		
Ed Wagner, AB9FN	333	01-Jul-02	David Bartholomew, AB0TO	716	22-Mar-02	Robert Hamilton, N0RN	377	19-May-87
Eldon Boehm, NK9U	313	21-Nov-86	Kevin Naumann, N0WDG	629	17-Nov-02	David Avery, N0HEQ	298	13-Jan-88
Allan Bukowski, N9ZD	310	01-Jun-92	Harry Steger, Jr., W0HMS	551	26-Aug-08	Jeffrey Weinberg, W0QO	287	01-Apr-93
Donald Hlinsky, N9LZU	299	01-Mar-91	Roland Kramer, W0RL	521	21-Jun-01	Philip O'Kunewick, AB0JR	274	24-Feb-00
Timothy Pechtold, AA9BV	274	01-Nov-92	Jeanette Nordman, AB0YX	460	21-Aug-03	David Sharpe, KI0HG	254	02-Feb-98
<b>Dakota</b>			<b>New England</b>			<b>Southeastern</b>		
John Schwarz, Jr., AE0AL	307	26-Oct-94	Robert Beaudet, W1YRC	380	01-Aug-90	Victor Madera, KP4PQ	462	01-Mar-92
Jeffrey Goodnuff, W0KF	301	17-Jun-03	Paul Lux, K1PL	342	25-Jan-85	Val Jacyno, AK4MM	385	08-Nov-11
Shep Shepardson, N0NMZ	245	12-Mar-01	Bruce Anderson, W1LUS	338	11-Feb-88	Pablo Soto, KP4SJ	370	01-May-92
Daniel Royer, KE0OR	235	01-Jul-91	Lawrence Polowy, KU1L	337	02-Jan-85	Robert Cumming, Sr., W2BZY	351	29-Jan-97
Dennis Ackerman, KB0OQQ	220	15-Jul-96	James Mullen, KK1W	332	01-Mar-91	Joseph Patti, N4UMB	319	01-Sep-90
<b>Delta</b>			<b>Northwestern</b>			<b>Southwestern</b>		
Arthur Parry, Jr., WB4BGX	267	01-May-91	Richard Morgan, KD7GIE	450	11-Aug-00	Bill Martin, AI0D	1,025	01-Nov-84
Glenn King, N5GK	244	05-Jun-86	Loren Hole, KK7M	380	06-Sep-84	Fred Bollinger, AB7JF	531	17-Apr-95
Joe Lowenthal, WA4OVO	234	25-May-06	George Ftikas, N7TQZ	299	01-Dec-92	David Morrill, N7TWT	422	20-Jul-00
Roger Gray, N5QS	226	01-Mar-93	David Brooks, N7HT	292	10-Jun-87	Steve Gurley, KY7W	409	19-Apr-96
Bobbie Williams, W1BEW	211	01-Jun-92	S. Riley McLean, W7RIL	288	02-Sep-99	Joseph Cutitta, W0SLL	406	09-Nov-99
<b>Great Lakes</b>			<b>Pacific</b>			<b>West Gulf</b>		
Charles Hall, W8HF	282	01-Jun-92	Morris Jones, AD6ZH	474	27-Nov-01	Franz Laugermann, K3FL	1,039	01-Dec-91
Dale Pritchett, KC8HJL	223	26-Mar-98	Dieter Stussy, KD6LVW	411	27-Jan-94	Wilbert Cannonier, KK5JJ	465	03-Nov-95
Archie Mack, Sr., AF4EB	222	19-Aug-97	Gordon Fuller, WB6OVH	348	06-Sep-84	Adolph Chris Koehler, K5VCR	460	29-Sep-95
Christian Anderson, K8VJ	219	09-Feb-90	Bill Nichols, NN7K	326	01-Sep-93	Gerald Grant, WB5R	460	04-Jan-85
James Viele, W8JV	210	22-Mar-90	Jim Brunk, N6BHx	280	13-Jul-95	David Fanelli, KB5PGY	435	01-Oct-91
Stanley Arnett, II, AC8W	210	06-Sep-84						

## Write for QST

The membership journal of ARRL is always open to manuscript submissions from ham radio operators.

QST looks for material that appeals to a broad cross-section of readers within the diverse Amateur Radio community. Feature articles published in QST fall into one of two broad categories: *technical* and *general interest*.

Technical articles outline a construction project or a technical concept. General interest articles are "everything else" that's not technical: recaps of DXpeditions, grid expeditions, or public service activities; personal accounts of trying a new mode or style of operating — anything relating to operating or the ham radio avocation.

Whether your manuscript has a technical or general focus, a strong "how-to" component will make it stand out. Readers should come away from the article with specific ideas for recreating your experience.

Please note that QST only considers complete manuscripts — we do not evaluate concepts or ideas for manuscripts. The best way to find out whether the editors of QST are interested in your idea is to write the article and send it in for consideration via postal mail or email (no phone calls, please).

For more information on what QST is looking for, and how to submit manuscripts, see our Author Guide at [www.arrl.org/qst-author-guide](http://www.arrl.org/qst-author-guide).

# A Look Back

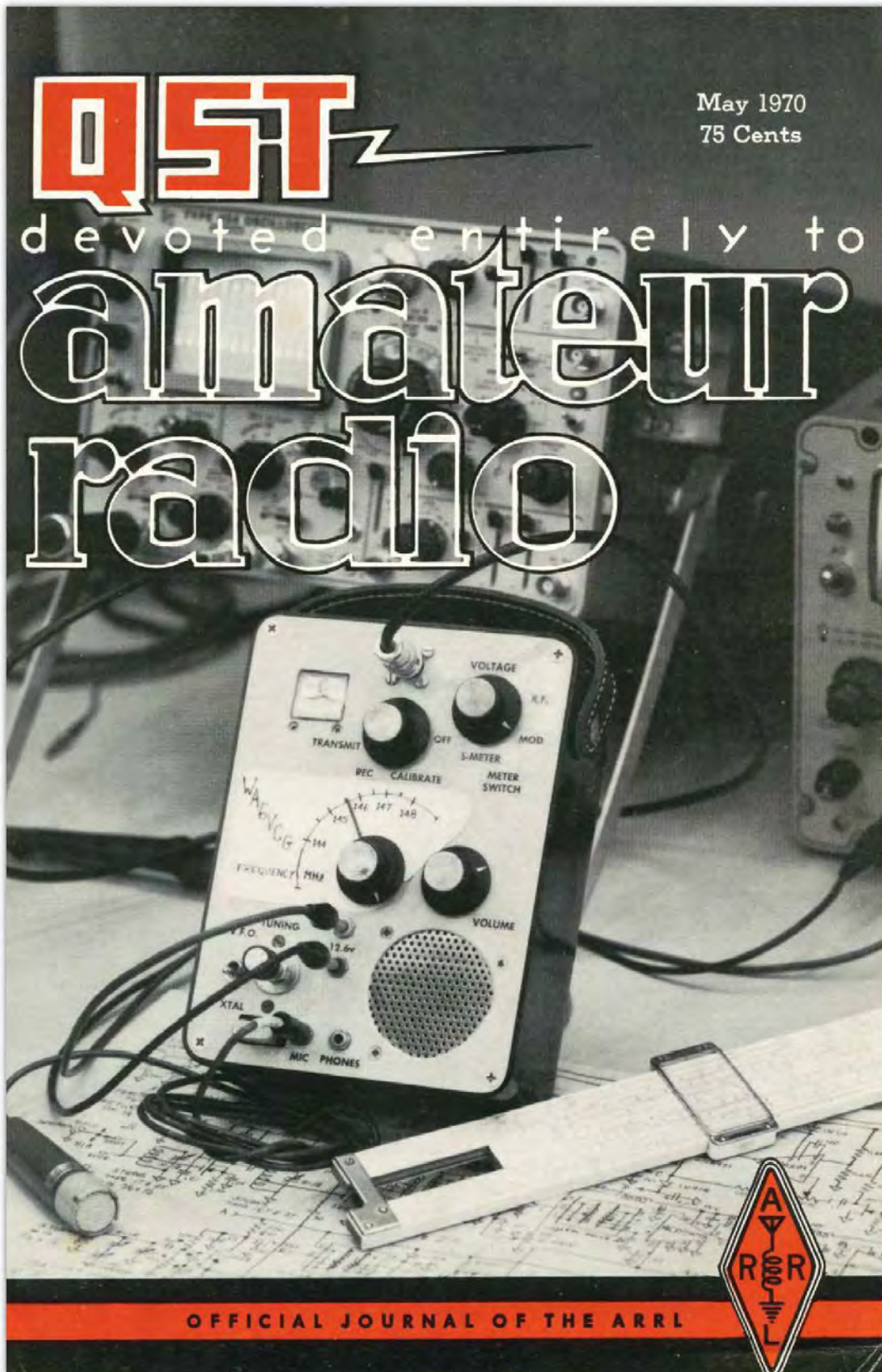

● *Beginner and Novice*

## A Solid-State Selectoroid

*Audio Selectivity With a Simple Device*

BY LEWIS G. McCOY,\* W1ICP

ONE OF the more serious problems the Novice has to contend with is QRM. The Novice bands, particularly 80 and 40 meters, can become very congested at times, and trying to copy a desired station can sometimes be very difficult. To make the problem even worse, many Novices start out in amateur radio using low-priced receivers that are lacking in selectivity. While it is possible to rework a receiver to improve the selectivity, most Novices are reluctant to dig into a receiver to make changes. This is understandable because it does take a certain amount of know-how and experience to modify equipment.

On the other hand, it can be very difficult to separate stations in a congested band if the receiver has poor selectivity. Many newcomers have the mistaken notion that the answer is to have more bandwidth on their receivers. However, this is rarely the case.

Basically, bandwidth is the ability of a receiver to cover a given frequency range by "spreading" the band out on the tuning dial. However, it doesn't mean that two stations that are operating close together are more separated. It just means that you can tune across the two stations at a slower rate. The ability of a receiver to separate stations that are close together is called *selectivity*, or the ability to select the *desired* signal, and discriminate against others.

There are many methods by which the selectivity of a receiver can be improved. One of the

\*Novice Editor

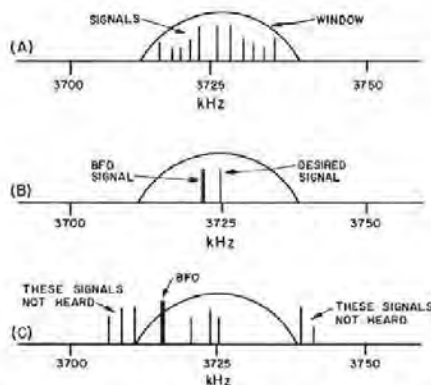

Fig. 1 — This drawing illustrates the discussion in the text.



The Selectoroid is housed in a homemade aluminum box. Two aluminum U-shaped channels are used for the case.

simplest, because it doesn't necessarily require any internal modifications to the receiver, is called audio selectivity. The Selectoroid, described in this article, is a device that will provide such selectivity. It is easy to build and get working, and can prove a real boon under QRM conditions.

### How It Works

Let's take a moment to visualize how a receiver works as far as selectivity is concerned. Also, let's suppose we are going to tune the Novice portion of the 80-meter band, 3700 to 3750 kHz. Just for an illustration, let's assume our tuning dial is a window that we can move up and down the band as we operate the tuning dial. Our window has a certain width, and this width can be called the *bandwidth* of the receiver. Any signals that appear in the window, can be heard. Fig. 1, at A, is an illustration of this window and represents the Novice portion of the band.

In order to hear cw signals, we need a beat-frequency oscillator signal in our window. As we move our window, the BFO signal moves right along with the window. Now, let's suppose there is a signal at 3725 kHz, as in Fig. 1 at B. As our BFO signal approaches the other signal, the two signals beat against one other, resulting in a signal that is the audio difference between the two. If our BFO is 3000 Hz away from the desired signal, we would

In December 1966 *QST* we described a tube version of a selective audio filter. The unit was called a Selectoroid. Here is a transistorized version of the same unit.



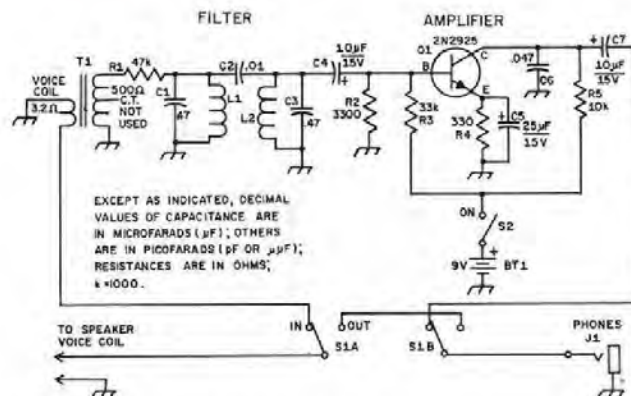

Fig. 2 — Circuit diagram of the solid-state Selectoroid. Capacitances are in uF, resistances are in ohms, and all resistors are 1/2 watt. Circuit designations not given below are for parts placement reference.

- BT1 — 9-volt battery.
- C1, C3 — 0.47-uF paper.
- C2 — 0.01-uF disk ceramic.
- C4, C7 — 10-uF electrolytic, 15 working volts or higher.
- C5 — 25-uF electrolytic, 15 working volts or higher.
- J1 — Headphone jack.
- L1, L2 — 88-mH toroid. See text.
- Q1 — 2N2925.
- S1 — 2pdt toggle (See text).
- S2 — Spst toggle.
- T1 — Transistor output transformer, 3-ohm voice coil, 500-ohm primary, primary center tap not used, (Lafayette Radio catalog No. 99 H 6123).

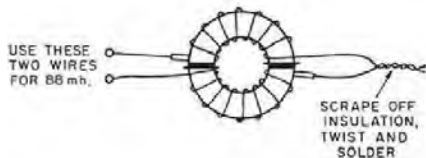
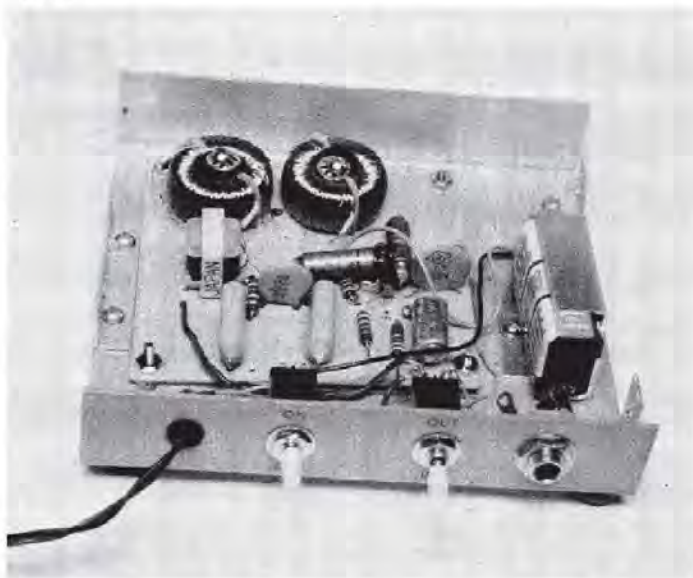

Fig. 3 — This drawing shows the method for connecting the toroid windings to obtain the required 88-mH inductance.

Inside view of the audio filter. Most of the parts are mounted on an etched-circuit board (left). L brackets are shown on the left and right edges of the bottom cover. These are used as anchor points for the top cover when it is attached. Sheet-metal screws hold the top cover to the brackets.



hear a 3000-Hz tone in our headphones. As the BFO signal is moved closer to the desired signal, the difference decreases, and the resulting tone gets lower and lower in pitch. When the two signals are on the same frequency, they are said to be *zero beat* and there will be no tone in our headphones.

As we continue to tune the BFO signal in the same direction, past the other signal, the difference between the two increases and the audio note also rises in pitch. The side of the signal we *are not* listening to is called the *audio image signal*.

Let's assume that our window is 16,000 Hz wide (16 kHz). If our desired signal was at the edge of the window, and our BFO at the exact center, we would start hearing an 8000-Hz tone, gradually decreasing in pitch until we reached zero beat, and then increasing as the window was moved past the desired signal.

From the example just given, it should be apparent that if we had two signals in the window, at opposite sides of the BFO, we would hear both signals because the BFO would beat against both. In the ideal setup, the BFO signal should be set near the edge of the window, as in Fig. 1 at C. Under these conditions, the BFO can *only* beat against signals that are to one side of the BFO and inside the window. This type of selectivity is called *single-signal selectivity*, because the audio image of

the signal is not heard. Also, it follows that the narrower the window, the more the undesired signals will be rejected.

If the Novice is shopping for a new receiver, he'll find that most of the better receivers have built-in filters that usually provide a "window" of about 2100 Hz (2.1 kHz). The reason that this figure is chosen is because 2100 Hz is about as narrow as one can get and still provide good intelligibility of phone signals. With the BFO set on the edge of such a passband, *only* signals within the passband will be heard. In some receivers, the purchaser may have the option of buying an additional filter for cw. These are usually on the order of 500 Hz, and some are as sharp as 200 Hz.

Naturally, the question many newcomers would ask is, "Can I install such a filter in my present receiver?" The answer is yes, but as pointed out earlier, it isn't an easy task for a newcomer who doesn't have the know-how. This leads us up to the Selectoroid — a method for improving the selectivity in the audio channel, or at the output end of the receiver.

Fig. 2 is the circuit diagram of the Selectoroid. The important parts of the unit are the two tuned circuits, C1L1, and C3L2. These are sharply-resonant circuits tuned to approximately 800 Hz. When our window and BFO are tuned across a

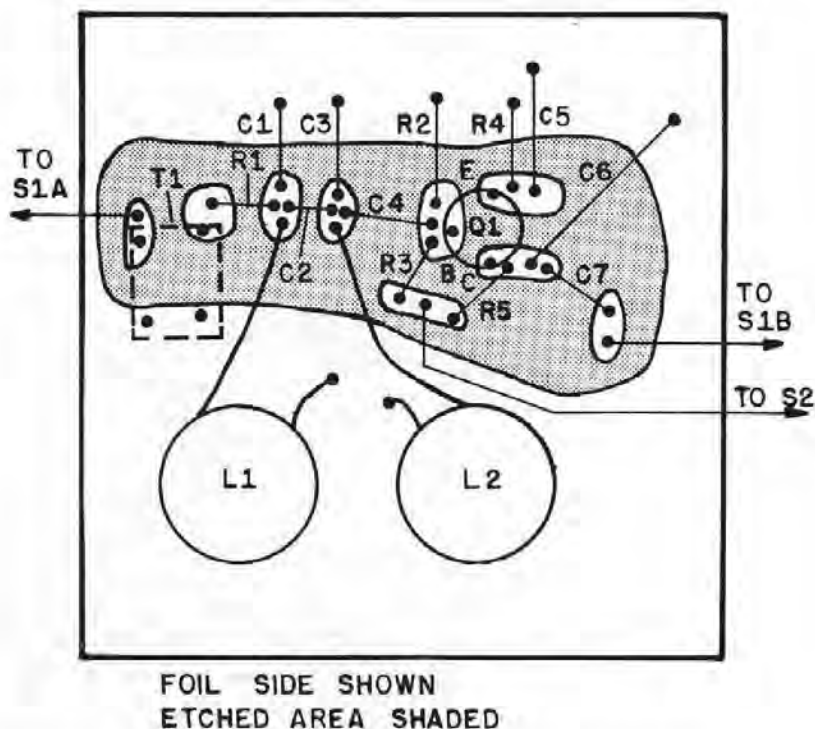

Fig. 4 — Layout of the etched-circuit board. The etched, or foil side is shown. (Ready-made circuit boards can be purchased from Stafford Electronics, 427 S. Benbow Rd., Greensboro, N.C. 24701.)

signal, all the audio range of the signal will be attenuated with the exception of a very narrow portion of the signal around 800 Hz. The listening effect is that when the receiver is tuned to 800 Hz, the cw note will peak quite sharply. Or in other words, the filter will "select" that portion of the signal around 800 Hz and attenuate everything else. No modifications of the receiver are required, and the only connections needed are to the speaker terminals on the receiver.

Because there is some audio loss through the Selectoroid, an audio amplifier stage, Q1, was added to the unit. The unit is powered by a 9-volt battery. The drain on the battery is only a couple of milliamperes, so BT1 should last almost as long as its normal shelf life. S1 is a double-pole, double-throw toggle switch that is used to switch the Selectoroid in or out.

#### Construction Information

The inductors used for L1 and L2 are types made for teletype units and you'll find them advertised in *QST* Ham Ads every month. The prices vary, but the toroids can usually be obtained for about 50 cents each. As they come, the toroids have two windings on them. These windings must be connected in series in order to obtain the required 88-mH inductance. Fig. 3 is a sketch that shows how the windings should be connected. Be sure to scrape the enamel covering from the wires before soldering them together.

In the unit shown, an etched-circuit board is used for mounting the components. Fig. 4 shows the etched side of the board with the various components marked off as lines to show their placement on the board. All the components are mounted on the unetched side of the board. A recent article in *QST*<sup>1</sup> covered the construction of etched-circuit boards in considerable detail, so the subject won't be treated here. Layout of the circuit is not at all critical, and any arrangement of the parts will work.

When mounting the transistor on the etched-circuit board, be sure to use a heat sink on the leads being soldered. This will prevent damage to the transistor. We mounted the completed board in a homemade low-profile cabinet, as shown in the photograph. The dimensions for the box, made from cookie-sheet aluminum, are 5 x 5 inches, with a 1-inch high lip on the front and back. The toggle switches used are of the miniature type, and if the normal-size toggles are used, the back and front lip of the box should be 1 1/2 inches high. You don't have to build the unit exactly as shown, as any size box that will hold the parts will work. However, we like the low-profile enclosure because it takes up less desk space than a larger cabinet would.

In order to keep the bottom side of the etched board from shorting to the metal chassis, a piece of stiff cardboard is mounted between the metal chassis and the bottom of the board. Make sure, however, that there is a good connection from the metal chassis ground to the copper-foil ground on the etched-circuit board.

<sup>1</sup>Schiebold, "Fast'n' Easy Printed Circuits," *QST*, August, 1969.

#### Using The Selectoroid

After the unit is completed it should be hooked up to the station receiver. The two leads from the Selectoroid can be connected to the voice coil terminals on the receiver, or at the speaker. The input of the Selectoroid is designed for 3- to 8-ohm impedance, which should be in the range of your speaker's impedance. The leads from the Selectoroid can be connected directly in parallel with the speaker leads if desired. However, some users might like to have the speaker shut off while listening with the headphones. All that is necessary in such a case is a single-pole switch to open one of the speaker leads when the Selectoroid is in use. Be sure you connect the Selectoroid leads on the receiver side of the switch, otherwise you'll be shutting off the input to both the speaker and the Selectoroid.

All you need do to use the Selectoroid is tune in a cw signal. As you tune across the signal you'll hear a sharp peak around the 800-Hz region. Switching the Selectoroid in and out of the receiver output will quickly show you just how much the unit eliminates QRM. As was said earlier, this is an easy and cheap method for improving your receiver's performance. **QST**



#### Ham Radio at AFCEA - 1970

On-the air ham radio facilities will be provided by the U.S. Navy's Washington voice in the amateur radio fraternity, K4NAA, operating daily from the Sheraton Park Hotel in Washington, D.C. during the three days of the Armed Forces Communication and Electronics Association Convention in June. AFCEA convention delegates with amateur radio licenses are invited to take advantage of the Navy's ham radio station to contact friends during the convention on June 2, 3, and 4.

The K4NAA fixed portable station will be operational from 0900 to 2200 EDST with two available positions for cw, ssb, and RTTY on the 10-, 15-, 20-, 40-, and 80-meter bands.

A specially designed QSL card has been prepared to acknowledge contacts with licensed amateurs throughout the world who are invited to make contact during the AFCEA convention.

The Navy and AFCEA invite all amateur radio enthusiasts to visit K4NAA on June 2, 3, and 4.

#### Feedback

There is a dimensional discrepancy in the drawing of the 2-meter repeater antenna shown in January, 1970 *QST* page 24. The 18 1/2-inch dimension is the length of the pipe insert. The 19 3/4-inch dimension is correct for the stub length. Thanks to W9OFL for calling this to our attention.

The Post Office Department promises faster mail service with the new Zip codes. Use yours when you write League Headquarters. Use ours, too. It's 06111.



# THE IC-2F COMES HOME.

Yes, you can enjoy two meter FM in the hamshack using the IC-2F with its companion AC power supply, the IC-3P. It is specially built to be attached directly to the IC-2F, and contains a built-in discriminator meter.

Features of the IC-2F: All solid state • 20 watts in • 6 channels • Automatic Protection Circuit for final amplifier protection • Super hot receiver with FET, IC, and ceramic filters • Beautifully designed in side and out.

For more information  
write



## **VARITRONICS INCORPORATED**

Arizona Interstate Industrial Center  
2321 E. University Dr.  
Phoenix, Arizona 85034

Or ask your dealer

See us at the Burbank Hamfest, the Pacific SW Convention,  
and the Eastern FM Convention, all in May.

# Celebrating Our Legacy

## Getting Started with CW

In the spring of 1953, I was about to graduate from eighth grade. My Novice license had arrived in the mail, but I had no equipment or practical knowledge about ham radio.

One of my father's coworkers used to be a shortwave listener and had a Hallicrafters SX-62A multiband radio receiver he wasn't using, so he lent it to me.

The SX-62A was the most beautiful piece of equipment I had ever used. It had 16 vacuum tubes and a huge front frequency-select face. It was heavy — 65 pounds. Because it was designed for listening to shortwave radio stations, it had no fine-tuning (band-spread) control. The ham frequencies were a tiny segment on the dial — the entire 80-meter band was only 1 inch wide, and as a Novice I could only use a tenth of that space. But the SX-62A did have a CW position for copying Morse code.

We set the radio on a table in our enclosed back porch, and I strung a wire out of the window and up into our attic for an antenna. Every evening I could hear ham stations loud and clear. My Morse skill was getting better — I heard new Novice hams like me, located nearby and around Chicago.

My father and I went to a store in Chicago that sold World War II military surplus electronic equipment, and we bought a radio headset and a J-38 telegraph key, both brand new and in their original boxes. These bargain electronic parts stores had sold joint Army Navy (JAN) 1625 vacuum tubes for 25 cents

each, new 811A generators for \$1, and brand new ARC-5 radios in the box for \$5.

My dad and I built a simple one-tube transmitter using some parts from an old table radio and other parts donated by our ham neighbor.

The design was from a Novice project described in a 1952 issue of *CQ Amateur Radio* magazine. It had a single cathode-keyed 6L6 tube, used my 80-meter crystal, and had a surplus 0-250 mA meter for tuning. Our ham neighbor checked it out for me — it put out 8 W!

**Roy Rusin, W6II**  
Saint George, Utah

## Playing Radio

The Christmas of 1956 came 3 days after my 15th birthday. More than anything else, I wanted to be a ham radio operator, so I wanted a shortwave receiver.

I discovered ham radio in the fourth grade when I saw a friend's basement, which had one whole wall covered in large metal boxes with dials and meters on them. I was told it was a ham radio station, but was never given a demonstration of it. As a Boy Scout, my Scoutmaster (who was also my dad) taught me Morse code. He had learned it in pilot training during World War II.

I knew that copying code was the first requirement, and so I wanted that short-

wave receiver. On Christmas morning, there was a large box under the tree for me from Walter Ashe Radio in St. Louis, Missouri. When I opened it, I was confused and disappointed to find three small aluminum chassis and a lot of parts. Each set came with four pages of instructions and a

wiring diagram — one each for the power supply, receiver, and transmitter. I would have to build my radio. But at least I would have a complete station when (and if) I built it.

That Christmas afternoon, a neighbor called to ask if I was using my radio because her TV was acting strangely. The radio was still in the box, in kit form. I had my first TVI complaint!

Not knowing a resistor from a tube socket, I somehow got the rig built. And, it worked on the first try! I spent hours listening to hams and coastal traffic stations to practice copying code. At first, I could only hope to find someone slow enough that I could pick out just one character.

I hooked the transmitter up to a 40 W lightbulb and spent many happy hours making imaginary contacts using made-up call signs. My sending speed far outstripped my receiving ability. Knowing now what I know about the dummy load characteristics of a lightbulb, I was probably being heard all around town, if not farther!

**Dave Sublette, K4TO**  
Winchester, Kentucky  
Life Member

Send reminiscences of your early days in radio to "Celebrating Our Legacy," ARRL, 225 Main St., Newington, CT 06111 or [celebrate@arrl.org](mailto:celebrate@arrl.org). Submissions selected for publication will be edited for space and clarity. Material published in "Celebrating Our Legacy" may also appear in other ARRL media. The publishers of *QST* assume no responsibility for statements made in this column.



The Walter Ashe Novice station from the September 1953 issue of *Radio and Television News*.



The Hallicrafters SX-62A shortwave receiver.

## Classic Radio

# The History of Collins Radio

Over time, brands become iconic for their superb engineering, remarkable dependability, and unequalled style. One of the most iconic brands in radio is Collins Radio Company. From military and amateur radio equipment to flight navigation and space communications, Collins Radio has always been a leader in its field. The reasons for the company's success are found in its history.



Lead photo — Gold Dust Twins. [Gary Halverson, K6GLH, photo]

### The 1920s

At just 9 years old, Arthur A. Collins formed his first station with a Quaker Oats box as a tuning coil and a Ford Model T spark coil. In 1923, at age 14, Collins earned his radio license from the Federal Radio Commission, before it became known as the Federal Communications Commission (FCC). His call was 9CXX.

The following year, Collins found notoriety through his communication with the MacMillan Expedition in Greenland, using his own equipment. Having the exclusive means to talk with the expedition each night brought him nationwide fame.

His reputation grew when he wrote about the schematics for a CW transmitter and various oscillator circuits for the May 1926 issue of *Radio Age*. In the summer of 1927, Collins, as 9ZZA, conducted mobile experiments in conjunction with the US Naval Observatory (USNO) in Washington, DC. The stage was set for him to begin designing and building amateur radio equipment.

### The 1930s

Collins wanted to change the design of “breadboard” nests of wires to solid pieces of equipment with hard wiring and metal craftsmanship fit for desk-top display. For the first time, amateur

equipment featured quality components, fine engineering, and sound wiring that would last for years.

Collins' business began with an ad in the January 1932 issue of *QST*, featuring a CW transmitter kit starting at \$37.25. The tagline read, “The smoothest, neatest little rig you ever saw — and what a Kick she has.” At the time, the units were constructed in the basement of his home.

The first assembled and tested Collins gear available to hams was a 30 W, crystal-controlled transmitter with plug-in coils, featuring a Bakelite front panel with a steel chassis. It included the hallmarks of all Collins Radio products to come — advanced engineering, resilient construction, professional displays, and sound performance.

Following the success of the 30 W transmitter was a cavalcade of transmitters during the 1930s: the 150 series; 40A/B; tuners labeled 2A, 2B, 2C, 32A, and 32B for CW and AM; 4A; 30FXB; the extremely popular 45A, 32FX, 32G, 32FXC, 32FXR, and the 30J, which was the last transmitter design before World War II.

Collins Radio Company catapulted into the national spotlight after Richard E. Byrd's 2nd expedition to Antarctica in January 1934. A headline in the *Collins Signal* newsletter (published by Collins Radio) read, “The Byrd Antarctic Expedition II Sails With A Complete Collins Short Wave Broadcasting Station Aboard!” The Collins 20B transmitter was the 6,000-mile link that shared the progress of Byrd's expedition with the world, through a relay connection with CBS News Radio in New York.

### The 1940s

With the completion of the 30J transmitter in the late 1930s, Collins retooled for war production with the construction of its main facility in Cedar Rapids, Iowa in 1940. During this period of growth, many of his engineering feats were accomplished: including the AN/ART-13 transmitter, autotune system, permeability tuned oscillator (PTO), resnatron, and cyclotron.

The AN/ART-13 with autotune was an extremely popular transmitter, especially among the United States Army Air Corps (USAAC). Its hallmark was the autotune system, designed to prevent tedious retuning

of the transmitter with each change in frequency. The engineers designed an automated mechanical system of rotating tuning shafts to match the transmitter to the desired frequency.

The PTO was Collins' next landmark development. It was designed by Ted Hunter at Collins Radio to create a more stable variable frequency oscillator (VFO). The PTO incorporated a variable inductance for tuning using a ferrite rod that screwed in and out of a tuning coil. It was introduced in the AN/ART-13 transmitter in 1945.

## The 1950s

The 1950s was a period of expansive production of iconic amateur radio equipment. In addition, Collins created many "firsts" with military radios. The company launched a two-box system of desktop ham transmitters and receivers called the "A line." Many know the 75A-3 receiver and the KWS-1 kWh SSB/CW transmitter as the "Gold Dust Twins." The two units were cabled to act as one, which was new in the field of amateur radio electronics (see the lead photo).

Taking it one step further, Collins combined two boxes (transmitter and receiver) into one unit called the KWM-1 "transceiver," which could be used in mobile settings. It was used in U2 spy planes and many other military applications.

An SSB airborne system was proposed by Collins to General Curtis LeMay as a means of solving the Strategic Air Command's (SAC) problem of connecting all SAC aircraft and land bases around the world using HF frequencies.

Another first during the 1950s was when Collins Radio entered the world of space communications with its navigational equipment for Project Mercury. The equipment was designed to cover voice, telemetry, rescue, tracking, and command functions of the space missions.

## The 1960s

Highlighting Collins' product line in the 1960s was the S-Line. It was a replacement for the famous A-Line and Gold Dust Twins series of transmitters and receivers. Like the two-box desktop series before it, the S-Line transmitters and receivers could operate jointly like a transceiver or separately. Included in the design was the famous S-Line PTO (70K2). Additional components included the 30L-1 linear amplifier, 62S-1 transverter for 6 and 2 meters, 312B-4 console, and the 312B-5 VFO.

Advancements were made in the 1960s with the KWM-1 transceiver, resulting in the new KWM-2/2A radio. Power input was 175 W PEP on SSB or 160 W on CW, and operated on 80 through 10 meters.

Production of space communications from the previous decade continued with the Apollo missions. Collins provided the data and communications equipment. There were S-band transceivers, VHF transceivers, astronaut-to-astronaut systems, and various other equipment.

Although Collins became renowned for its surface applications of mobile and land-based radios, they also developed the AN/URC-32 for submarines. The rig became the fleet's primary communication system once SSB replaced AM.

A relatively unknown development in Collins Radio was its takeover battle with Ross Perot because of the Collins Radio "C-System" computer program putting financial stress on the company. Eventually, in early 1969 when Collins stock had fallen, Ross Perot tried to merge Collins Radio with his Electronic Data Systems company. However, the takeover failed because banks felt his company was too small.

## The 1970s

During this process, the banks learned the depth of Collins' financial woes. They determined that Collins spent too much of its assets on research and development, especially on its computer system.

This convinced Arthur Collins that he needed a financial partner. In 1971, North American Rockwell invested \$35 million in Collins Radio and won the right to choose most of its board members.

During this time, they developed a series of advanced radio equipment, including the 100 W KWM-380 transceiver released in the fall of 1979, which replaced the KWM-2.

## Collins Today

Collins Radio became Rockwell Collins and operated as such for 17 years, until United Technologies acquired them in 2018. Today, the company is called Collins Aerospace, reflecting its emphasis on space and flight electronics. According to a Collins Aerospace representative, the company no longer produces amateur radio equipment. However, the Collins Radio legacy will endure for years to come.

For more information and a list of sources, visit [www.k4vrc.com/uploads/7/8/8/6/78865320/collins\\_history\\_presentation\\_tvarc\\_9-21\\_\[w3my\\_russ\].pdf](http://www.k4vrc.com/uploads/7/8/8/6/78865320/collins_history_presentation_tvarc_9-21_[w3my_russ].pdf).

## Strays

### Maritime Radio Day April 14 and 15

Maritime Radio Day is a celebration of nearly 90 years of the maritime wireless service. Open to all amateur radio stations, it will begin April 14 at 12:00 UTC and end April 15 at 22:00 UTC. You'll find complete details at [trafficlist.altervista.org/mrd/](http://trafficlist.altervista.org/mrd/).

# 100, 50, and 25 Years Ago

## March 1920

- The cover artwork shows a ham shack far removed from the house, with a ham making the most of the atmospheric quiet of the winter months.
- The editorial announces that *QST* will no longer be available by subscription to non-members. Henceforth, ARRL membership and subscription to *QST* are one and the same.
- F. H. Schnell and R.H.G. Mathews discuss "Radio Club Organization," pointing out the need for local organization of amateurs in a manner that meshes with our national organization.
- The Old Man describes the "Rotten Hours" he has to keep to get all his messages sent.
- The editor shares a method of "Minimizing QRM" that was developed during the Great War, when it was successfully used by American and British forces. It uses a wave-trap circuit and has become known as "the red plug."
- A. Groves, who concentrates his radio efforts on improving receiving circuits, presents his thoughts "On the Use of Honey-Comb Coils."
- ARRL Traffic Manager J.O. Smith recounts his experiences during "A Little Journey" that took him through 20 states, as he visited prominent radio amateurs.
- B.B. Skeete discusses the use of "Telephone Jacks in Amplifiers."
- "A Dutch Amateur Valve" reviews the first Dutch-made amateur tube, made by the Philips Lamp Works, comparing its performance with that of American tubes.

## March 1970

- The magazine cover shows Doug DeMaw's, W1CER, QRP 80- and 40-meter transceiver, described in this issue.
- The editorial notes that this is the first issue of *QST* produced by the new IBM composition equipment at Headquarters.
- Rudolf Fischer, DL6WD, presents a description of his slightly unconventional homebrew solid-state receiver, in "An Engineer's Ham-Band Receiver."
- Wayne Overbeck, K6YNB, discusses "High Versus Low Antennas," and shares the results of performance tests using identical arrays at different heights.
- Katashi Nose, KH6IJ, outlines "A Simple Safety Feature for Crank-up Towers."
- Lewis Collins, K4GGI, talks about "The K4GGI 220-MHz Kilowatt Amplifier."
- John Daebelliehn, WN9BJC, explains how to build "A Two-Element 15-Meter Quad for the Novice."

## March 1995

- The cover photo montage portrays several aspects of ham radio at this time, including the 40th anniversary of the San Bernardino Microwave Society.
- The editorial notes that amateurs are now on the verge of instant licensing.
- In "A Journey to the Center of Asia," Terry Langdon, W6/G3MHV, shares how a business trip across Russia allowed him to do some DXing from Tuva (in Zone 23), while learning about this little-known country.
- Jim Ford, N6JF, describes how he built "A 'Rope Ladder' 2-Meter Quagi" that is 100 feet long, and "gets out like gangbusters."
- Ben Spencer, G4YNM, reports on building "An Audio Break-Out Box" that takes one audio output to provide four identical outputs for various accessories.
- Ulrich Rohde, KA2WEU, tells us how we can use off-the-shelf phase-lock-loop (PLL) and direct digital synthesis (DDS) parts with a pair of voltage-controlled oscillators (VCO) to build "A High-Performance Hybrid Frequency Synthesizer" that outperforms the synthesizers in current commercial ham gear.
- Gary Diana, N2JGU, urges readers to "Try Building Your Own Equipment" from *QST* articles.





# Silent Keys

It is with deep regret that we record the passing of these radio amateurs:

K1DXA **Bittel**, Philip W., Torrington, CT  
 N1G DY **King**, Dennis F., Upton, MA  
 AG1M **Mildenberger**, Edmund John, Brighton, CO  
 K1MAA **Fascione**, Frank J., Tolland, CT  
 N1RJS **Skinner**, Richard J., Mooresboro, NC  
 W1RY **Bintliff**, Raymond P., Acton, MA  
 WA1UNQ **Calkins**, Richard A., Gloucester, RI  
 W1VCU **Denison**, Nelson C. "Denny," Bowie, MD  
 N1W5G **Britland**, Glenn H., Seekonk, MA  
 W1YIN **Goodhue**, Edward W., Jr., Bourne, MA  
 NS2A **Kennedy**, William C., Barrington, NJ  
 WB2ASH **Hall**, James E., Philadelphia, NY  
 N2BO **Brady**, Walter C., Jr., Edwards, NY  
 KB2DPD **Musella**, Gerard, Elmont, NY  
 N2FER **Brummer**, Ann E., Queensbury, NY  
 •WB2GIU **Dwyer**, John F. "Jack," Averill Park, NY  
 ♦K2GFL **Geiger**, Everett A., Upper Saddle River, NJ  
 KN2L **Fort**, Robert G. "Jerry," Sr., Hamilton, NJ  
 AA2LN **Koble**, Ned A., La Follette, TN  
 WA2PMK **Mansey**, William F., Largo, FL  
 AD2Q **Rife**, David Charles, Fort Saint Lucie, FL  
 K2CQ **Skelly**, Donald F., Jr., Sauguit, NY  
 KJ2Q **Rajchel**, John W., New Hartford, NY  
 K2FA **Rager**, Donald M., Jr., Buffalo, NY  
 N2RGR **Dey**, Virgil C., York, SC  
 KB2SHD **Collignon**, Harry R., Jr., Larchmont, NY  
 WB2YRH **Cottriss**, Donald P., Waterford, NY  
 KC3AVE **Snyder**, Donald C., Mount Joy, PA  
 •K3BLJ **Shade**, Keith N., Findley Lake, NY  
 K3CHR **Wright**, John E., Lafayette Hill, PA  
 K3CLD **Dorian**, Charles L., Wheaton, MD  
 KN3E **Hoeck**, Edwin B., Jr., Heathsville, VA  
 K3FXX **Matland**, Danielle S., Marathon, FL  
 K3GFS **Binkley**, James G., Lewisberry, PA  
 N3KSB **Arnold**, Dean E., State College, PA  
 •N3MI **Nemeth**, Robert A., Salisbury, NC  
 KY3O **Tucker**, John A., Westview, KY  
 W3PJL **Jones**, Larry D., Nokomis, FL  
 KE3FE **Palmer**, William J., Jr., Charlotte Hall, MD  
 KA3TDQ **Sciulli**, Joseph D., Jr., Mount Washington, PA  
 N3USB **King**, Walter J., Glen Burnie, MD  
 W3WFM **Milligan**, William F., Upper Marlboro, MD  
 •N3WUC **Sciulli**, Mary Ann, Mount Washington, PA  
 KB3WVO **Weidner**, Robert L., Greentree, PA  
 •KE4AFK **Palmrose**, Kimberly S., Altha, FL  
 •K4AKA **Anderson**, Eugene, Mountain Grove, MO  
 WA4AKJ **Roach**, D. Joe, Cresview, FL  
 N4CFA **Austin**, John M. "Jack," Farmville, VA  
 W4OGC **Hallfors**, Dana J. "Finn," Asheville, NC  
 KY4COE **Coe**, John C., Bowling Green, KY  
 K4DEO **Willi**, Woodrow W., Cecilia, KY  
 K4DUB **Campbell**, Dub, Collinsville, TX  
 ♦N4DXS **Veader**, Stephen R., Dale City, VA  
 WA4EN **Novacek**, Eugene, Tuxedo Park, NY  
 WB4EEL **Hough**, Frances C., Macon, GA  
 K4GEJ **Abbott**, Earl T., Jr., Roanoke, VA  
 ♦K4IGN **Ortiz**, Juan M., Guayama, PR  
 K4GTF **Foveaux**, Gary T., Mineral, VA  
 KA4GYX **Cashwell**, Edgar A., Saxapahaw, NC  
 K4HZE **Laurer**, George J., Wendell, NC  
 •K4KEV **Gaddy**, Mary A., Clyde, NC  
 ♦W4KYS **Stitt**, Tony A., Bristol, TN  
 KB4LAG **Green**, Les A., Sauttee Nacoochee, GA  
 KO4M **Domingo**, Edward A., Ulica, OH  
 W4MKR **Ramm**, Mary K., Hillsborough, NC  
 KE4NBX **Evans**, Earl E., Jr., Gloucester, VA  
 N4NCT **Spurlin**, Lewis M., Jr., Durham, NC  
 KE4NUX **Darby**, Richard, Atlanta, GA

AF4OY **Paczkowski**, Richard F., Edgewater, FL  
 •N4PVY **Luce**, John W., Tampa, FL  
 N4PXQ **Baranyi**, Marcia L., Oak Ridge, TN  
 KD4QCP **McNaughton**, Fritz W., Lancaster, SC  
 KG4SNN **Latta**, David S., Midlothian, VA  
 ♦W4TTS **Hames**, Ann H., Shelby, NC  
 KJ4TYR **Smith**, James W., Heathsville, VA  
 ♦WB4WXP **Fountain**, Collier J., Sopchoppy, FL  
 W4YWH **Blocher**, Harold F., Sr., Highland Heights, KY  
 AB5AR **Kimbrell**, Virgil C., Columbus, MS  
 KB5CSQ **Byrd**, Betty, Gulfport, MS  
 K5DAH **Poirrier**, Louie, Pasadena, TX  
 KB5DFD **Carpenter**, Kenneth R., Nettleton, MS  
 W5JMO **O'Neal**, James M., Oxford, MS  
 KC5LOQ **Bellamy**, James D., Ponder, TX  
 K5MET **Brewer**, Tom C., Carrollton, TX  
 KF5VME **White**, Gary R., Quitman, MS  
 K5QM **Rochelle**, Jerry L., Altus, OK  
 •KE5NEH **Donahue**, Ruby M., Victor, TX  
 WA5VFO **Worsham**, Patrick J., Austin, TX  
 KV5WB **Wren**, Danny H., Lubbock, TX  
 W6DUH **Sharp**, Jacob, Carlsbad, CA  
 KJ6JUN **Reyes**, Carrie L., Orland, CA  
 KD6JSM **Philibert**, Larry G., Redlands, CA  
 N6LHX **Stembridge**, James E., Pagosa Springs, CO  
 WB6LFN **Pierce**, David E., Lompoc, CA  
 KB6FSW **Lee**, James C., Sr., Yucaipa, CA  
 •W6RYD **Kline**, Leonard, Solana Beach, CA  
 AE6SX **Pruitt**, Dan, Fresno, CA  
 •WA6TIB **Lopes**, Antonio P., Modesto, CA  
 WB6VKR **Gunderson**, Art, Santa Paula, CA  
 KJ6WPI **Hinson**, Wilber L., Marina, CA  
 N7ENN **Mani**, Carl J., Louisville, OH  
 KL7JUN **Fields**, Wayne, Oregon City, OR  
 KB7KO **Christensen**, Thor E., Brookfield, VT  
 ♦A17P **Lundy**, Joe W., Battle Mountain, NV  
 KD7S **Radder**, William, Bellingham, WA  
 AG7U **Jones**, William B., Sanger, CA  
 W7ZO **Garcia**, Alfred A., Snowflake, AZ  
 KC8AKT **Fleury**, Joseph A., Vancouver, WA  
 KB8BK **Bellner**, Patricia A., Maurice, OH  
 WB8CC **Ridgeway**, Harley D., Belding, MI  
 •NB8YE **Goddard**, Daniel R., Jr., Garden City, MI  
 •WB8YX **Harris**, Jim, Mansfield, OH  
 WA8JKG **Comstock**, David W., Hurricane, WV  
 KD8LZW **Cummons**, Jon, Lewis Center, OH  
 KB8VNE **Adams**, Allan J., Lincoln Park, MI  
 K8NKE **McClaren**, William E., Salem, OH  
 ♦WB8RAE **Messerschmidt**, Dale W., Tecumseh, MI  
 N8RAK **Jaker**, William B., East Windsor, NJ  
 KF8S **Beal**, Albert James, Salineville, OH  
 KB8SK **King**, G. Stewart, Troy, OH  
 W8BT **Boggs**, George J., Mbgadore, OH  
 KB8LXX **Munski**, Gregory J., Grand Rapids, MI  
 ♦KB8WXX **Harvey**, Michael E., Saint Marys, OH  
 KB8WON **Werner**, Roy W., Columbiana, OH  
 KA8ZKT **Lewis**, Mark W., Avon Lake, OH  
 W8AKG **Kish**, Thomas, Tipton, MI  
 W8JUR **Nickell**, Phillip G., Las Cruces, NM  
 K9CQ **Koch**, Robert, Mount Sterling, IL  
 W8EDB **Childers**, Timothy C., Jacksonville, IL  
 WD9HAS **Barrett**, Elbert Dyle, Freeport, IL  
 KC9JKZ **Voros**, Joe F., Milwaukee, WI  
 KD9LZM **Hoefler**, Karen E., Dakota, IL  
 •KC9MVT **Vyse**, David L., Appleton, WI  
 KA9VUS **Stombaugh**, Gerald C., Tucson, AZ  
 K9YFY **Kedney**, Catherine A., Waukesha, WI  
 •K9YFY **Keithley**, Garold S., Normal, IL  
 •K9YFY **Barnes**, Betty A., Rochelle, IL

WB9ZCG **Delaney**, Dolan R., Washington, IN  
 K9ZMV **Scheuerell**, Orville J., Sun Prairie, WI  
 AK9BG **Boyvey**, Don E., Des Moines, IA  
 KY9F **Paul**, Eddy S., Lenexa, KS  
 N9GTW **Plumb**, James, Loveland, CO  
 ♦K9IVO **Grossman**, Erwin H., Saint Louis Park, MN  
 WB9MNP **Weiskopf**, Kevin R., Union, MO  
 KD9UIK **Murphy**, Stephen, Stevens Point, WI

- ♦ Life Member, ARRL
- Former call sign

For information on how to list a Silent Key in QST, please visit [www.arrl.org/silent-key-submission-guidelines](http://www.arrl.org/silent-key-submission-guidelines).

Note: Silent Key reports must confirm the death by one of the following means: a copy of a newspaper obituary notice, a copy of the death certificate, or a letter from the family lawyer or the executor. Please be sure to include the amateur's name, address, and call sign. Allow several months for the listing to appear in this column.

Many hams remember a Silent Key with a memorial contribution to the ARRL Foundation or to ARRL. If you wish to make a contribution in a friend or relative's memory, you can designate it for an existing youth scholarship, the Jesse A. Bieberman Meritorious Membership Fund, the Victor C. Clark Youth Incentive Program Fund, or the General Fund. Contributions to the Foundation are tax deductible to the extent permitted under current tax law. Our address is: The ARRL Foundation Inc., 225 Main St., Newington, CT 06111.

## Strays

### QST Congratulates...

Bryant Rascoll, KG5HVO, on achieving the rank of Eagle Scout. An ARRL member, Bryant was honored in a ceremony last December in Montgomery, Alabama. One of the Troop 307 leaders, David Pinkston, is shown doing the honors.



# HAM RADIO OUTLET

WWW.HAMRADIO.COM

**NOBODY BEATS AN HRO DEAL!**



**NEW**

## IC-9700 | All Mode Tri-Band Transceiver

- VHF/UHF/1.2GHz • Direct Sampling Now Enters the VHF/UHF Arena • 4.3" Touch Screen Color TFT LCD • Real-Time, High-Speed Spectrum Scope & Waterfall Display • Smooth Satellite Operation



## IC-718 | HF Transceiver

- 160-10M\*\* • 100W • 12V operation • Simple to use • CW Keyer Built-in • One touch band switching • Direct frequency input • VOX Built-in • Band stacking register • IF shift • 101 memories



## ID-5100A Deluxe VHF/UHF Dual Band Digital Transceiver

- Analog FM/D-Star DV Mode • SD Card Slot for Voice & Data Storage • 50W Output on VHF/UHF Bands • Integrated GPS Receiver • AM Airband Dualwatch



## IC-7851 | HF/50MHz Transceiver

- 1.2kHz "Optimum" roofing filter • New local oscillator design • Improved phase noise • Improved spectrum scope • Dual scope function • Enhanced mouse operation for spectrum scope



## IC-R8600 | Wideband Software Defined Receiver

- 10 kHz to 3 GHz Super Wideband Coverage • P25, NXDN™, dPMR™, D-STAR Mode • Large Dot Matrix LCD Display w/ Quick Spectrum Scope • SD Card Slot • Remote Control Function



## ID-4100A | VHF/UHF Dual Band Digital Xcvr

- Compact, Detachable Controller for Flexible Installation • DV/FM Near Repeater Search Function • Apps for iOS™ and Android™ devices • Wireless Operation with VS-3 & UT-137 Bluetooth® Headset & Module • MicroSD Card Slot



## IC-7700 | HF/50MHz Transceiver

The Contester's Rig • HF + 6m operation • +40dBm ultra high intercept point • IF DSP, user defined filters • 200W output power full duty cycle • Digital voice recorder



## IC-7100 | All Mode Transceiver

- HF/50/144/430/440 MHz Multi-band, Multi-mode, IF DSP • D-STAR DV Mode (Digital Voice + Data) • Intuitive Touch Screen Interface • Built-in RTTY Functions

## IC-V86 | VHF 7W HT

- 7W Output Power Plus New Antenna Provides 1.5 Times More Coverage • More Audio, 1500 mW Audio Output • IP54 & MIL-STD 810G—Rugged Design Against Dust & Water • 19 Hours of Long Lasting Battery Life • 200 Memory Channels, 1 Call Channel & 6 Scan Edges



## IC-7610 | HF/50 MHz All Mode Transceiver

- Large 7-inch color display with high resolution real-time spectrum scope and waterfall • Independent direct sampling receivers capable of receiving two bands/two modes simultaneously



## IC-2730A | VHF/UHF Dual Band Transceiver

- VHF/VHF, UHF/UHF simultaneous receive • 50 watts of output on VHF and UHF • Optional VS-3 Bluetooth® headset • Easy-to-See large white backlight LCD • Controller attachment to the main Unit



## IC-R30 | Digital/Analog Wideband Xcvr

- 100 kHz to 3.3 GHz Super Wideband Coverage • P25 (Phase 1), NXDN™, dPMR™, D-STAR Mode • 2.3" Large LCD Display & Intuitive User Interface • MicroSD Card Slot for Voice & Data Storage • USB Charging & PC Connection



## IC-7300 | HF/50MHz Transceiver

- RF Direct Sampling System • New "IP+" Function • Class Leading RMDR and Phase Noise Characteristics • 15 Discrete Band-Pass Filters • Built-In Automatic Antenna Tuner



## IC-2300H | VHF FM Transceiver

- 65W RF Output Power • 4.5W Audio Output • MIL-STD 810 G Specifications • 207 alphanumeric Memory Channels • Built-in CTCSS/DTCS Encode/Decode • DMS

## ID-51A PLUS2 VHF/UHF D-STAR Portable

- RS-MS1A, free download Android™ application • New modes for extended D-STAR coverage • Terminal Mode & Access Point Mode allow D-STAR operation through Internet • DV & FM repeater search function • Dplus reflector link commands



**5 Ways to Shop!**

- **RETAIL LOCATIONS** – Store hours 10:00AM - 5:30PM - Closed Sunday
- **PHONE** – Toll-free phone hours 9:30AM - 5:30PM
- **ONLINE** – WWW.HAMRADIO.COM
- **FAX** – All store locations
- **MAIL** – All store locations

**ICOM**

ANAHEIM, CA  
(800) 854-6046

OAKLAND, CA  
(877) 892-1745

PORTLAND, OR  
(800) 765-4267

PHOENIX, AZ  
(800) 559-7388

MILWAUKEE, WI  
(800) 558-0411

WOODBIDGE, VA  
(800) 444-4799

PLANO, TX  
(877) 455-8750

BURBANK, CA  
(877) 892-1748

SAN DIEGO, CA  
(877) 520-9623

DENVER, CO  
(800) 444-9476

ATLANTA, GA  
(800) 444-7927

NEW CASTLE, DE  
(800) 644-4476

SALEM, NH  
(800) 444-0047

**ONLINE STORE**  
**WWW.HAMRADIO.COM**

\*\*Except 60M Band. \*\*\*Frequency coverage may vary. Refer to owner's manual for exact specs. \*\*Optional UX-9100 required. QST MARCH 2020. The Icom logo is a registered trademark of Icom Inc. Toll-free including Hawaii, Alaska and Canada. All HRO 800-lines can assist you. If the first line you call is busy, you may call another. Prices, specifications and descriptions subject to change without notice.

# HAM RADIO OUTLET

WWW.HAMRADIO.COM

**MARCH IS YAESU MONTH AT HRO!**



**FTDX5000MP Limited | 200W HF + 6M Xcvr**

- Internal Power Supply • Two Totally Independent Receivers
- Super Sharp "Roofing" Filters • High Performance Yaesu Custom-designed 32-bit Floating Point DSP • True Analog Meter Precision



**FTDX3000 | 100W HF + 6M Transceiver**

- 100 Watt HF/6 Meters • Large and wide color LCD display • High Speed Spectrum Scope built-in • 32 bit high speed DSP /Down Conversion 1st IF



**FT-991A | HF/VHF/UHF All Mode Transceiver**

- Real-time Spectrum Scope with Automatic Scope Control • Multi-color waterfall display • State of the art 32-bit Digital Signal Processing System • 3kHz Roofing Filter for enhanced performance • 3.5 Inch Full Color TFT USB Capable • Internal Automatic Antenna Tuner • High Accuracy TCXO



**FTDX101D | HF + 6M Transceiver**

- Narrow Band SDR & Direct Sampling SDR • Crystal Roofing Filters Phenomenal Multi-Signal Receiving Characteristics • Unparalleled - 70dB Maximum Attenuation VC-Tune • 15 Separate (HAM 10 + GEN 5) Powerful Band Pass Filters • New Generation Scope Displays 3-Dimensional Spectrum Stream



**FT-891 | HF+50 MHz All Mode Mobile Transceiver**

- Rugged Construction in an Ultra Compact Body • Stable 100 Watt Output with Efficient Dual Internal Fans • 32-Bit IF DSP Provides Effective and Optimized QRM Rejection • Large Dot Matrix LCD Display with Quick Spectrum Scope • USB Port Allows Connection to a PC with a Single Cable • CAT Control, PTT/RTTY Control



**FT-857D | Ultra Compact HF/VHF/UHF**

- 100w HF/6M, 50W 2M, 20W UHF • DSP included • 32 color display • 200 mems • Detachable front panel (YSK-857 required)



**FT-2980R | Heavy-Duty 80W 2M FM Transceiver**

- Massive heatsink guarantees 80 watts of solid RF power • Loud 3 watts of audio output for noisy environments • Large 6 digit backlit LCD display for excellent visibility • 200 memory channels for serious users



**FTM-100DR | C4FM FDMA/FM 144/430 MHz Xcvr**

- Power Packed System Fusion Transceiver • High Audio Output Power • Rugged Powerful Transmitter • Integrated 66ch High Sensitivity GPS • 1200/9600 APRS Data Communications



**FTM-400XD | 2M/440 Mobile**

- Color display-green, blue, orange, purple, gray • GPS/APRS • Packet 1200/9600 bd ready • Spectrum scope • Bluetooth • MicroSD slot • 500 memory per band



**FT-70DR C4FM/FM 144/430MHz Xcvr**

- System Fusion Compatible • Large Front Speaker delivers 700 mW of Loud Audio Output • Automatic Mode Select detects C4FM or Fm Analog and Switches Accordingly • Huge 1,105 Channel Memory Capacity • External DC Jack for DC Supply and Battery Charging

**FT-3DR C4FM/FM 144/430 MHz Xcvr**

- High Res Full-Color Touch Screen TFT LCD Display • Easy Hands-Free Operation w/Built-In Bluetooth Unit • Built-In High Precision GPS Antenna • 1200/9600bps APRS Data Communications • Simultaneous C4FM/C4FM Standby • Micro SD Card Slot



**FT-65R | 144/430 MHz Transceiver**

- Compact Commercial Grade Rugged Design • Large Front Speaker Delivers 1W of Powerful Clear Audio • 5 Watts of Reliable RF Power Within a compact Body • 3.5-Hour Rapid Charger Included • Large White LED Flash-light, Alarm and Quick Home Channel Access



**FT-60R | 2M/440 5W HT**

- Wide receiver coverage • AM air band receive • 1000 memory channels w/alpha labels • Huge LCD display • Rugged die-cast, water resistant case • NOAA severe weather alert with alert scan



- **RETAIL LOCATIONS** – Store hours 10:00AM - 5:30PM - Closed Sunday
- **PHONE** – Toll-free phone hours 9:30AM - 5:30PM
- **ONLINE** – WWW.HAMRADIO.COM
- **FAX** – All store locations
- **MAIL** – All store locations

**YAESU**  
The radio

ANAHEIM, CA (800) 854-6046	OAKLAND, CA (877) 892-1745	PORTLAND, OR (800) 765-4267	PHOENIX, AZ (800) 559-7388	MILWAUKEE, WI (800) 558-0411	WOODBIDGE, VA (800) 444-4799	PLANO, TX (877) 455-8750
BURBANK, CA (877) 892-1748	SAN DIEGO, CA (877) 520-9623	DENVER, CO (800) 444-9476	ATLANTA, GA (800) 444-7927	NEW CASTLE, DE (800) 644-4476	SALEM, NH (800) 444-0047	<b>ONLINE STORE</b> <b>WWW.HAMRADIO.COM</b>

# Eliminate Radio Frequency Interference



As our lives become filled with technology, the likelihood of electronic interference increases. Every lamp dimmer, garage door opener or other new technical "toy" contributes to electrical noise around us. The good news is that most cases of interference can be cured. With these resources you'll find ways to reduce or eliminate interference around you.

## The ARRL RFI Book

ARRL's team of highly trained experts have compiled the best advice available on every type of radio frequency interference. From automotive to television, from computers to DVD players, from audio equipment to telephones, you'll find a step-by-step process for eliminating problematic interference in one convenient book. Includes resources for addressing digital cable TV and satellite systems, over-the-air TV signals, troubleshooting, and hybrid and all-electric automobiles.

ARRL Item No. 0915  
Only \$29.95

## RFI Pocket Guide

This guide to essential radio frequency interference is a valuable, pocket-sized reference for radio amateurs and others in the radio communication fields. Designed as a practical, quick reference, it gathers the key facts and useful reference materials in one place to help the reader understand basic EM theory, along with specific steps in reducing or eliminating sources of radio interference. Includes EMC/RFI Fundamentals, EMC design, FCC rules, locating RFI and resolving RFI.

ARRL Item No. 5008  
Only \$20



**ARRL** The national association for  
AMATEUR RADIO®

[www.arrl.org/shop](http://www.arrl.org/shop)  
Toll-Free US 888-277-5289,  
or elsewhere +1-860-594-0355

**ICOM**<sup>®</sup>

FIRST IN TECHNOLOGY

# Be Active: IC-705

Your New Partner for Field Operations

- HF/50/144/430 MHz All Mode, with D-Star DV
- RF Direct Sampling System
- Real-Time Spectrum Scope and Waterfall Display
- Large Touch Screen Color Display
- Compact and Lightweight Design
- BP-272 Battery Pack or 13.8 V DC External Power Supply
- Maximum Output Power 10 W (13.8 V DC), 5 W (BP-272)
- Bluetooth<sup>®</sup> and Wireless LAN Capabilities
- Full Equipped D-STAR Functions
- Optional Backpack, LC-192, Ideal for Field Operations



**Be Active!**  
In the field with the IC-705



HF/50/144/430 MHz <SSB/CW/RTTY/AM/FM/DV> 10 W TRANSCEIVER



**IC-705** Coming Soon



[WWW.ICOMAMERICA.COM](http://WWW.ICOMAMERICA.COM)

For the love of **ham radio.**

©2020 Icom America Inc. The Icom logo is a registered trademark of Icom Inc. All other trademark remain the property of their respective owners. All specifications are subject to change without notice or obligation. 31358

As of Jan. 2020 this device has not been approved by the Federal Communications Commission. This device may not be sold or leased, or be offered for sale or lease, until approval of the FCC has been obtained.

**Transform your audio and hear more clearly..  
..with a bhi DSP noise canceling product!**

**bhi**  
**DESKTOP**

**ParaPro EQ20 Audio DSP Range with Parametric Equalisation**



- Powerful high performance audio processing system
- 20W audio and parametric equalisation on all units
- DSP noise canceling and Bluetooth versions available
- Fine-tune your audio to maximise your enjoyment
- Simple control of all DSP functions

**EQ20B-DSP QST Dec 2019 review: "easy-to-use device that improves the audio clarity of amateur signals"**

**New NES10-2MK4**

**Dual In-Line**

Fully featured amplified DSP noise canceling in-line module  
- Mono or stereo input and outputs - Headphone socket - Latest bhi DSP noise canceling technology - Suitable for all radios, receivers and SDR - Ideal for DXing and club stations



**New improved NES10-2MK4**

- 5W audio power and the latest bhi DSP noise cancelling (8 to 40dB)
- Up to 65dB tone reduction
- Function switch on top of speaker for ease of use
- Power on, filter on and audio overload LED

**Manufactured in the UK by bhi Ltd**

**DX ENGINEERING**

DXEngineering.com -1-800-777-0703

- 10W Amplified DSP noise canceling speaker - Easy to use controls - 8 DSP filter levels**
- Line and speaker level inputs
  - "Real time" audio adjustment
  - Suitable for all radios incl' SDR



**Compact In-Line**

Easy to use portable in-line noise cancelling unit with simple "real time" control of audio and DSP functions



High-performance audio processing removes noise on all bands so you can hear weak signals clearly!

[www.bhi-ltd.com](http://www.bhi-ltd.com)

E & O.E.



**GREEN HERON ENGINEERING LLC**

**RT-21 DIGITAL ROTATOR CONTROLLERS**

Unmatched Performance for any Rotator



**RT-21 Rotator Packages**

- RT-21 with Yaesu & M2 Orion Rotators

**RT-21 internal Wi-Fi Option**

- Control your rotator from ANYWHERE using a web browser

**WIRELESS NETWORK CONTROLS**

- Internet access for switches and rotators
- Eliminate cables and tethered control boxes
- Create customized on-screen controls
- Great circle maps



**GH Everywhere Base and Remote**



- USB and wireless relay controls
- Options: outdoor enclosures and external antennas

**Select-8 Wireless Remote Coax Switch**

- Built-in GHE Wireless
- Powered through the coax
- Tower leg Mount
- Amphenol RF connectors



Select-8
Tri-Bander
40 Meter Beam
40 Meter Dipole
75 Meter Vert.
80 Meter Dipole
10 Meter 5 El
160 Meter "V"
Dummy Load

[www.greenheronengineering.com](http://www.greenheronengineering.com) (585) 217-9093

**POCKET REF**

By Thomas J. Glover

All the information you'll ever need is right at your fingertips!

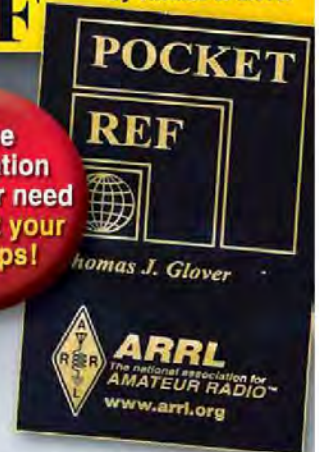

This handy pocket-sized guide features tables, charts, drawings, lists, and formulas especially useful for radio amateurs, contractors, students, travelers, electronics hobbyists, craftspeople, and engineers and technicians in virtually every field. Embossed with ARRL's logo and logotype —making this a particularly special edition.

ARRL Item No. 1148

**Only \$12.95\***

\*plus shipping and handling



The national association for  
**ARRL AMATEUR RADIO**  
[www.arrl.org/shop](http://www.arrl.org/shop)

QST 2/2020



## 2019 ARRL PERIODICALS on DVD

ARRL's popular journals are available on a compact, fully-searchable DVD. Every word and photo published throughout 2019 is included!

- **QST** The official membership journal of ARRL
- **NCJ** National Contest Journal
- **QEX** Forum for Communications Experimenters

**SEARCH** the full text of every article by entering titles, call signs, names —almost any word. **SEE** every word, photo (including color images), drawing and table in technical and general-interest features, columns and product reviews, plus all advertisements. **PRINT** what you see, or copy it into other applications.

**System Requirements:** Microsoft® Windows and Macintosh systems, using the industry standard Adobe® Acrobat® Reader® software. The Acrobat Reader is a free download at [www.adobe.com](http://www.adobe.com). Windows Vista, 7, 8, and 10 compatible.

### 2019 ARRL Periodicals on DVD

ARRL Item No. 1274  
Only \$24.95

The **2019 ARRL Periodicals** is also available as a **download** in a **Windows Version** (ARRL Item no. 1274\_WD) and **Mac/Linux Version** (ARRL Item no. 1274\_MLD).



**ARRL** The national association for AMATEUR RADIO®  
[www.arrl.org/shop](http://www.arrl.org/shop)



**EXPERT LINEARS**  
America LLC

ExpertLinears@Att.net  
ExpertLinears.com  
Distributor for the Americas



## Fully Automated Solid State Linear Power Amplifiers

Most Technologically Advanced in the World!



Expert 2K-FA

Expert 1.5K-FA

Expert 1.3K-FA

Expert 1.5K FA Product Review Nov 2019 QST

### Superior Operating Capabilities

Built In Power Supply & Automatic Antenna Tuner  
Follows Transceiver & Fully Remoteable!  
Automatically Changes Bands, Antennas & Stores in Memory  
The CPUs intelligently protect and control the linears plus produce warning & alarm messages. Compatible W/Modern Transceivers.

### Sales & Expert Amps Service

- ★ SPE Factory Trained over 8 years
- ★ Warranty/Non Warranty Service/All SPE Amps

See **EVENTS**  
on our  
Website

Expert 1.3K FA PRODUCT REVIEW  
July 2016 QST

**ORDER CABLES**  
kc5pcb2@Att.Net

EXPERT LINEARS AMERICA, LLC  
PO Box 1224, Magnolia, TX 77353  
Contact: Bob Hardie W5UQ 281-259-7877

Authorized Distributor for Linear Amplifiers

### Still Struggling With Your 20-Year-Old Repeater Controller?



More Power, More Features  
Less Money

State-of-the-Art Repeater  
Controllers and Accessories

**Arcom**

Aurora, OR 97002 (503) 678-6182  
[www.arcomcontrollers.com](http://www.arcomcontrollers.com)

### Rw AntennaStore

"New York's Only  
Amateur Radio/Ham Store"

More Free Shipping than Anyone!!

MFJ, Hy-Gain, Cushcraft, Tram,  
Radio Oasis, Jetstream, Opek,  
Comet, Hustler, Alinco, LIDO,  
Daiwa... and many more!!

— Website —

[www.rwantennastore.com](http://www.rwantennastore.com)

— Telephone —  
(716) 434-9216

— Address —

6150 Crosby Rd, Lockport, NY 14094

# iC for iCOM!

Our iC element has been specially designed to work with iCOM transceivers. All Heil headsets are available in an iC version.



*"The Northwest's Largest Ham Convention"*



# SEA PAC



ARRL Northwestern Division Convention

## June 5-7, 2020

Seaside Convention Center - Seaside, Oregon

*Workshops Fri. - Seminars & Exhibits Sat. & Sun.*

Banquet  
New Products  
DX & YL Luncheons

**NO SALES TAX  
IN OREGON**

VE Testing  
Flea Market Tables  
Commercial Exhibits

Near the Beautiful Pacific Northwest Ocean Beach

GENERAL INFORMATION  
Wayne Schuler, AI9Q  
360.892.5580 • info@seapac.org

EXHIBITOR INFORMATION  
Warren Winner, W7JDT  
503.644.0752 • exhibitors@seapac.org

For more information about SEA-PAC visit [www.seapac.org](http://www.seapac.org)



# Your Roadmap to Radiosport!

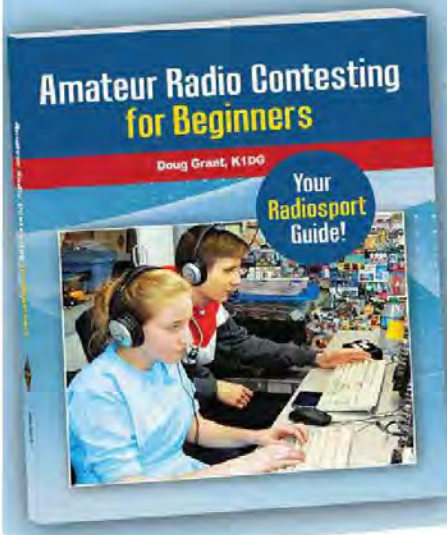

## CQ Contest...CQ Contest...

Contesting is one of the most exciting aspects of Amateur Radio. It's called "radiosport" because it really *is* a sport – a competition to see who can contact the most stations in an allotted amount of time. Regardless of the size of your station, you can compete, too!

Everything you need to get started

- Equipment advice
- Operating guidance
- Software suggestions
- Digital contesting tips

...and much more!

Written by radiosport veteran Doug Grant, K1DG, this new book will put you on the path to competitive excitement.

### Amateur Radio Contesting for Beginners

ARRL Item No. 1243

Only \$27.95

Member Price Only \$24.95



**ARRL** The national association for AMATEUR RADIO®  
www.arrl.org/shop

**Alpha Delta Radio Communications, LLC**  
The Leader of the "Pack"

**37**  
YEARS

Superior Customer Service  
Continuous Product Innovation

## Industry Leading Surge Protected Coax Antenna Switches.

Low Loss with excellent Co-Channel Isolation. Models DELTA-2B/N and DELTA-4B/N have been granted NSN numbers by the Defense Logistics Agency (DLA) for use in **ALL** U.S. and NATO applications, worldwide. Cage Code 389A5. Made in the U.S. in our ISO-9001 certified production facility.

The Alpha Delta **Model ASC Antenna Selector Console** desk top coax switch series brings a new level of versatility and convenience to your station operation. This series retains all the features and specifications of the precision 4 position DELTA-4B series (see WEB site for DELTA-4B specs, pictures and info), including ARC-PLUG™ module surge protection, in a desk top console that will sit right next to your equipment on your desk without having to be secured or bolted down. "Non-slip" feet attached for best stability.

The console features a powder coated steel housing and a solid brass ground buss, with #10 wire attachment hardware, across the rear of the housing providing a common ground point for all station equipment and accessories.

- **Model ASC-4B;**..... \$159.00 ea.  
Desk console, same as DELTA-4B
- **Model ASC-4B/N;**..... \$169.00 ea.  
Desk console, same as DELTA-4B/N

Our standard surge protected coax switch line (see WEB site for details):

- **Model DELTA-2B;**..... \$79.00 ea.  
2 position, UHF connectors, 500 MHz
- **Model DELTA-2B/N;**..... \$95.00 ea.  
2 position, N connectors, 1.3 GHz
- **Model DELTA-2B/TNC;**..... \$120.00 ea.  
2 position, TNC connectors, 1.3 GHz
- **Model DELTA-4B;**..... \$110.00 ea.  
4 position, UHF connectors, 500 MHz
- **Model DELTA-4B/N;**..... \$120.00 ea.  
4 position, N connectors, 1.3 GHz
- **Model D4 ARC PLUG;**..... \$9.00 ea.



Also available from **Alpha Delta** dealers.

**www.alphadeltaradio.com**  
for product technical details, installation requirements, pricing, dealers and contact information

# One Handbook, Three Formats. Choose Your Favorite!

**NEW**  
2020 ARRL  
Handbook!

—Traditional Softcover,  
Multi-Volume Set, and  
eBook Digital Editions

## New Projects and Content!

- **System Fusion update** by Cory Sickles, WA3UVV
- **Solar Cycle 24 update** by Carl Luetzelshwab, K9LA
- **Rotator ratings and application** by Ward Silver, NØAX, with Don Daso, K4ZA
- **Generator RFI choke** by James Brown, K9YC, and Glen Brown, W6GJB
- **Annual transceiver survey** by Joel Hallas, W1ZR, and Mark Wilson, K1RO

Plus, eBook and supplemental download included!

The multi-volume set is **workbench friendly**. Grab the volume you need without having to retrieve the entire *Handbook*. The six volumes are divided by major topic areas:

**Volume 1:** Introduction and Fundamental Theory

**Volume 2:** Practical Design and Principles PART 1

**Volume 3:** Practical Design and Principles PART 2

**Volume 4:** Antenna Systems and Radio Propagation

**Volume 5:** Equipment Construction and Station Accessories

**Volume 6:** Test Equipment, Troubleshooting, RFI, and Index

▶ For more information go to [www.arrl.org/arrl-handbook-2020](http://www.arrl.org/arrl-handbook-2020)

Softcover Edition

ARRL Item No. 1076

Only \$49.95

Six-Volume Set

ARRL Item No. 1137

Only \$59.95

The Kindle edition is

available as six separate volumes on Amazon, Only \$9.99 per volume

Softcover Edition



Digital eBook



**Six  
Volume  
Set**



**ARRL** The national association for  
AMATEUR RADIO®  
[www.arrl.org/arrl-handbook-2020](http://www.arrl.org/arrl-handbook-2020)

# Repeaters... Repeaters... Repeaters... Worldwide. It's Sooooo Easy!

- Get repeater details from up-to-date on-line sources. (Some require subscriptions.)
- Review and edit the result of the search. Make changes right in the Programmer.
- Create a file with all these channels with only two button clicks.
- In minutes you're ready to send details for lots of repeaters to your radio.

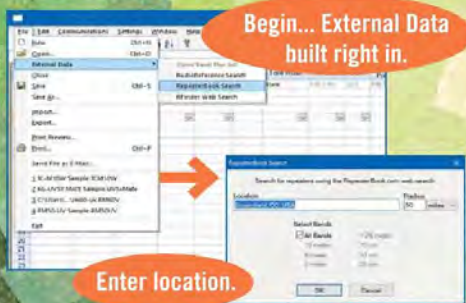

**442**  
408 unique radio Programmers... External data found in all unique radio Programmers.  
Check for your radio model at: [www.rtsystems.com](http://www.rtsystems.com)

**rt SYSTEMS**  
RADIO PROGRAMMING MADE EASY

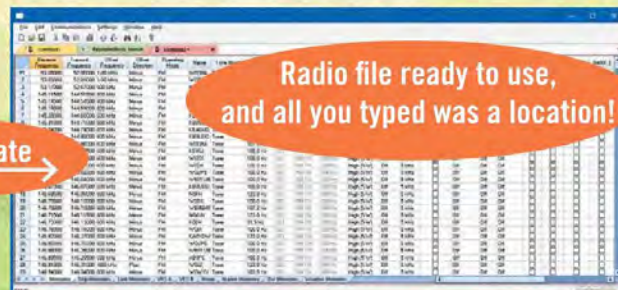

Eliminate unwanted channels.

Available from RT Systems or Your Local Radio Dealer  
800-476-0719 | [www.rtsystems.com](http://www.rtsystems.com)  
Personal Assistance Mon.-Fri., 8:00-5:00 MT, Sat. by Appointment

**Buckmaster OCF Dipoles**  
Built to last from quality materials!  
4-Band 68': 40, 20, 10, & 6 meters  
7-Band 135': 80, 40, 20, 17, 12, 10, & 6m  
8-Band 270': 160, 80, 40, 20, 17, 12, 10, 6m  
BUCKMASTER INTERNATIONAL 800-282-5628 HamCall.net  
540-894-0907

**Air Boss Antenna Launcher**  
[www.kr4loairboss.com](http://www.kr4loairboss.com)  
See Video  
For when you want your antenna on top  
**\$59.95**  
boss@kr4loairboss.com

**LARGE Tactical Radio Carrier**  
Fits: K3s, KPA500, IC-7200, IC-7300, FT-991A, FT-450, FT-857, FT-897, +Others  
Tac-Comm.com

**CABLE X-PERTS, INC.**  
Connecting You to the World...  
A Name You Can Trust  
**1-800-828-3340**

FOR PREMIUM ELECTRICAL PERFORMANCE FROM YOUR EQUIPMENT

Private labeling at no charge.  
Our quality products are also carried at:  
**HAM RADIO OUTLET**

We take great pride in our work!  
**Custom or Ready-Made Coaxial Assemblies**  
Visit us on-line for cable selection and great prices.  
Made in the USA  
Serving You Since 1989

Direct burial cables with glued heat shrink tubing. Contact us for details.  
**www.CableXperts.com**

**Mayberry Sales & Service**

**HONDA GENERATORS**  
EU2200i  
**\$1,049.00**  
\*expires March 31, 2020

Over 20 years in QST

Call for Special Shipping Details  
**MAYBERRYS.COM**  
**800-696-1745**  
232 Main St. Port Murray, NJ 07865  
Please read your Owner's Manual and all labels before operation.

# Dayton Hamvention®

Amateur Radio, The Future



Greene County Fairgrounds & Expo Center



**May 15 - 17 2020**

**Get Your Tickets Online NOW!**  
\$26 in advance or \$31 at the gate

- Exhibits & Flea Market
- Forums & Activities
- Networking & More!

## hamvention.org

## ARRL at 2020 Hamvention®



More Info at  
[www.arrl.org/expo](http://www.arrl.org/expo)

### Highlights

ARRL-sponsored activities, exhibits, representatives, special guests, DXCC card checking, and more.

### Store

Join, renew or extend your ARRL membership, and get the latest publications and Field Day merchandise.

### Event App

Download the ARRL events app to find booths, exhibits, forums, maps, hourly prize drawings, and more.



**ARRL** The national association for  
**AMATEUR RADIO®**

The First Choice of Hams Around the World!

# hy-gain® HF Rotators

## HAM-IV - \$709.95

The Most Popular Rotator in the World!

For medium communications arrays up to 15 square feet wind load area. Has 5-second brake delay, Test/Calibrate function. Low temperature grease permits normal operation down to -30 degrees F. Alloy ring gear gives extra strength up to 100,000 PSI for maximum reliability.

Precision indicator potentiometer. Ferrite beads reduce RF susceptibility. Cinch plug plus 8-pin plug at control box. Dual 98 ball bearing race for load bearing strength and electric locking steel wedge brake prevents wind induced movement. North/South center of rotation scale on meter, low voltage control, max mast 2 1/16".

**HAM-VI - \$809.95** with DCU-2

**HAM-VII - \$959.95** with DCU-3



## TAILTWISTER SERIES II - \$869.95

For Large Medium Antenna Arrays up to 20 sq. ft. wind load.

Has 5-second brake delay, Test/Calibrate functions. Low temp grease, tough alloy ring gear, indicator potentiometer, ferrite beads on potentiometer wires, weatherproof AMP connectors plus 8-pin plug at control box, triple bearing race with 138 ball bearings for large load bearing, electric locking steel wedge brake, North/South center of rotation scale meter, low voltage control, 2 1/16" max mast. **MSHD, \$139.95.** Above tower heavy duty mast support. T2X, HAM-IV, HAM-V, HAM-VI. Accepts 1 1/8"-2 5/8" OD.

**T-2XD2 - \$979.95** with DCU-2

**T-2XD3 - \$1039.95** with DCU-3



## CD-45II - \$499.95

For antenna arrays up to 8.5 sq. feet mounted inside tower or 5 sq. ft. with mast adapter.

Low temperature grease good to -30 F degrees. New Test/Calibrate function. Bell rotator design gives total weather protection, dual 58 ball bearing race gives proven support. Die-cast ring gear, stamped steel gear drive, heavy duty, trouble free gear train, North center scale, lighted directional indicator, 8-pin plug/socket on control unit, snap-action control switches, low voltage control, safe operation, takes maximum mast size to 2 1/16 inches. MSLD light duty lower mast support included.

**CD-45D2 - \$599.95** with DCU-2

**CD-45D3 - \$659.95** with DCU-3



Specifications	
Wind Load Capacity (inside tower)	15 square feet
Wind Load (w/mast adapter)	7.5 square feet
Turning Power	800 in.-lbs.
Brake Power	5000 in.-lbs.
Brake Construction	Electric Wedge
Bearing Assembly	Dual race/96 ball bearings
Mounting Hardware	Clamp plate/steel U-bolts
Control Cable Conductors	8
Shipping Weight	26 lbs.
Effective Moment (in tower)	2800 ft.-lbs

Specifications	
Wind Load Capacity (inside tower)	20 square feet
Wind Load (w/mast adapter)	10 square feet
Turning Power	1000 in.-lbs.
Brake Power	9000 in.-lbs.
Brake Construction	Electric Wedge
Bearing Assembly	Triple race/138 ball bearings
Mounting Hardware	Clamp plate/steel U-bolts
Control Cable Conductors	8
Shipping Weight	31 lbs.
Effective Moment (in tower)	3400 ft.-lbs

Specifications	
Wind Load Capacity (inside tower)	8.5 square feet
Wind Load (w/mast adapter)	5.0 square feet
Turning Power	800 in.-lbs.
Brake Power	800 in.-lbs.
Brake Construction	Disc Brake
Bearing Assembly	Dual race/48 ball bearings
Mounting Hardware	Clamp plate/steel U-bolts
Control Cable Conductors	8
Shipping Weight	22 lbs.
Effective Moment (in tower)	1200 ft.-lbs

New!

## Hy-Gain Programmable DCU-3 Digital Rotator Controller

DCU-3 - \$499.95

Hy-gain DCU-3 Digital Controller lets you program 6 beam headings! Gives you full automatic or manual control of your hy-gain HAM or Tailtwister Rotators.

Press a memory button or dial in your beam heading or let Ham Radio Deluxe (or other) take control. Your antenna auto rotates precisely and safely to your DX.

DCU-3 automatically jogs your antenna free and safely unlocks it before rotating begins (great for older rotators with "sticky" brakes) then turns off your motor before reaching its final heading. Your antenna gently coasts to a stop before the brake re-locks -- greatly reducing damaging overshoots and extending rotator life. Simply press *Left* and *Right* buttons for full manual control and fine tuning.

Bright blue LCD shows current, dialed in and computer controlled beam headings in one degree increments and your call.

Calibrate lets you accurately match your display to your true beam heading. Has USB/RS-232 ports for computer control. Adjustable LCD sleep time. Field upgradeable firmware. 8.5Wx4.3H x9D".

110 VAC. Order DCU-3X for 220 VAC.



### DCU-2 Digital Rotator Controller - \$459.95

Like DCU-3, but less programmable memories. 110 VAC. Order **DCU-2X**, for 220 VAC.

## AR-40 - \$399.95

For compact antenna arrays and large FM/TV up to 3.0 square feet wind load area.

Dual 12 ball bearing race. Automatic position sensor never needs resetting. Fully automatic control -- just dial and touch for any desired location. Solid state, low voltage control, safe and silent operation. 2 1/16 inch maximum mast size. MSLD light duty lower mast support included.



AR-40 Rotator Specifications	
Wind Load Capacity (inside tower)	3.0 square feet
Wind Load (w/mast adapter)	1.5 square feet
Turning Power	350 in.-lbs.
Brake Power	450 in.-lbs.
Brake Construction	Disc Brake
Bearing Assembly	Dual race/12 ball bearings
Mounting Hardware	Clamp plate/steel U-bolts
Control Cable Conductors	5
Shipping Weight	14 lbs.
Effective Moment (in tower)	300 ft.-lbs

## Replace your Yaesu Rotator Controller

### YRC-1 - \$369.95

Hy-gain YRC-1 -- more features, more robust, far less prone to lightning damage. Costs less than repairing!

Easy-to-use -- dial in your beam heading and tap GOTO button. Exclusive 180 degree *AutoReverse!*™ for fast longpath operation. All DCU-2 features. Bright blue LCD shows current, dialed-in, computer controlled beam headings, call. USB port for computer control. Extra heavy-duty AC power supply. Fast variable DC motor minimizes overshoot. Intuitive menu. Field upgradeable. For Yaesu G-800/1000/2800/G450/650. AC or DC motors.

**YRC-3, \$449.95.** Like YRC-1 and adds 6 memories.



## AR-500 Rotator/Controller - \$169.95

UHF/VHF/6-Meter, MFJ-1886 Rotator/Controller and Remote. For use of small VHF/UHF, 6M, TV, FM, the MFJ-1886 wide band receiving loop and other light-weight ham antennas. Rotator is built in a weather-proof one piece cast aluminum housing with precision all metal gears, steel thrust bearings and automatic braking. Includes rotator, controller, remote, clamps, and all hardware. AR-500 remembers up to 12 directions even after a power outage! Use remote control or direct console. Displays location and relative position.



**NEW**  
12th  
Edition

# The ARRL Operating Manual

## Your Guide to On-Air Operating Activities

Talking to friends. Serving your community. Chasing DX. Adding a new band. Trying a new mode. Working a contest. Taking your radio on the road or out in the field. These are just a few of the exciting and fun on-air operating activities to try once you have earned your license and mastered the basics.

*The ARRL Operating Manual* is as a comprehensive guide to amateur radio operating. This edition has been updated by experienced hams who are active on the air. They are happy to share what they have learned so that you can get involved and on the air too.

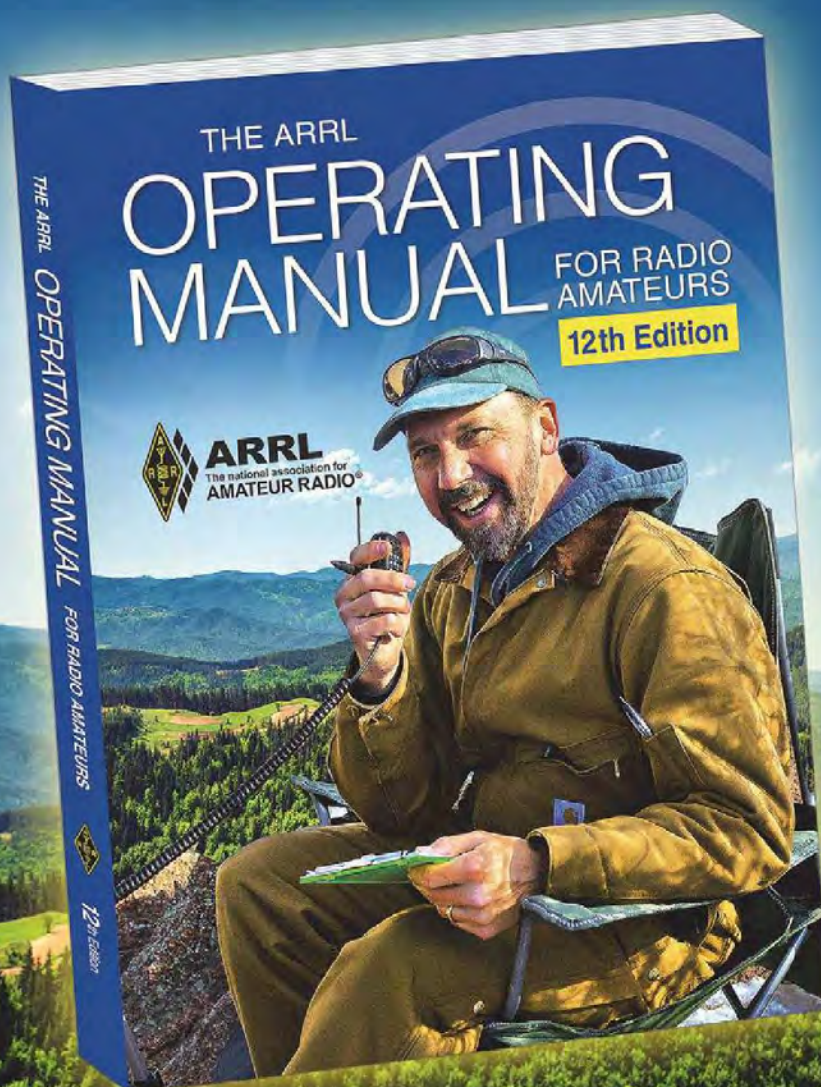

### Get On the Air!

- Learn basic operating procedures and how to set up your station.
- Become an active ham, contact radio amateurs around the world.
- Join a local radio club and enjoy amateur radio group activities.
- Volunteer your radio skills to serve your community.
- Participate in contests, and earn operating awards.

**Includes new material on FT8 and other WSJT-X digital modes.**

The ARRL Operating Manual  
ARRL Item No. 1205  
**Only \$24.95**



**ARRL** The national association for  
AMATEUR RADIO®

[www.arrl.org/shop](http://www.arrl.org/shop)

Toll-Free US 888-277-5289,  
or elsewhere +1-860-594-0355

# MFJ Magnetic Loop Antennas

**Build your own Mag loop!**



**MFJ 36-inch magnetic loop antenna lets you operate 7 to 22 MHz or 10 to 30 MHz continuously -- including the WARC and MARS bands! Easily handles a full 150 Watts on SSB/CW/Digital for any transceiver.**

Ideal for limited space -- apartments, small lots, motor homes, attics, or mobile homes.

Work exciting DX with low angle radiation and local close-in contacts with high angle radiation when mounted vertically.

Super easy-to-use! MFJ remote control auto tunes to your desired

See MFJ Youtube reviews at: [https://m.youtube.com/results?search\\_query=mfj](https://m.youtube.com/results?search_query=mfj)

## MFJ Magnetic Loop Tuners, 150 Watts



**Turns any wire loop into a small, high efficiency multi-band transmitting magnetic loop antenna!** Work the world on 3.5 to 30 MHz with a full 150 Watts SSB/CW/Digital. No ground, radials or counterpoises needed. Very quiet receiving antenna -- you'll hardly notice static crashes. High-Q reduces

## QRP Mag Loop Tuner



**MFJ-9232** Turns wire around a bookcase, window, tree, etc. into a small, high efficiency transmitting loop antenna! Operate 40-10 Meters with included flexible wire loop (80/60 Meters with your bigger loop). No counterpoises, radials, ground needed. 25 Watts. Very quiet reception. Hi-Q reduces QRM, overload, harmonics. Great for apartments, antenna restrictions, portable ops.

**MFJ-9232** \$69.95

VIDEOS: [https://m.youtube.com/results?search\\_query=MFJ-9232](https://m.youtube.com/results?search_query=MFJ-9232)

band. Fast/slow tune buttons, Cross-Needle SWR/Wattmeter lets you quickly tune to your exact frequency. No control cable needed.

**World's most efficient small loop antenna has all welded construction, welded butterfly capacitor with no rotating contacts, large 1.050 inch diameter aluminum radiator -- gives you highest possible efficiency.**

Every capacitor plate is welded for extremely low loss and polished to prevent high voltage arcing. Nylon bearing, anti-backlash mechanism, limit switches, continuous no-step DC motor gives smooth precision tuning. Heavy-duty ABS plastic housing has ultraviolet inhibitor protection.

**MFJ-1782, \$459.95.** Like MFJ-1786 but with fast/slow tune manual remote control.

**MFJ-1780, \$369.95.** 20-10 Meters, 150 Watt Portable 24x24x24" box fan loop with carrying handle. Highly efficient all-welded construction, no-rotating contact butterfly capacitor. Fast/slow tune remote control. No control cable needed. See QST July 2019 review. **MFJ-1780XX, \$449.95.** Like MFJ-1780 with auto band tune remote control, SWR/Wattmeter.

QRM, overloading, harmonics. Perfect for apartments, antenna restricted areas and portable operation.

A 13' wire loop covers 30-20 Meters (4' for 17-10M; 7' for 20-15M; 28' for 60-40M; 50' for 80M). Tune any shape loop -- circle, square, rectangle, etc.

A wire length gives about 1.5 to 1 frequency range (i.e. 7-10, 18-28 MHz).

MFJ low loss Butterfly loop tuning capacitor has no rotating contacts. Easy-Carry handle. Mount for PVC Cross loop support on cabinet top.

**MFJ-936B, \$299.95.** Antenna current meter, Cross-Needle SWR/Wattmeter. 9 1/4"Wx5 1/2"Hx9 1/2"D inches.

**MFJ-935B, \$249.95.** Antenna current meter. 6 1/4"Wx5 1/2"Hx9 1/2"D inches.

**MFJ-933, \$209.95.** 6 1/4"Wx5 1/2"Hx9 1/2"D".

## Antenna Rotator



Perfect for magnetic loops, VHF/UHF, small HF beams, TV, FM antennas. Weather-proof cast aluminum housing with precision all metal gears, steel thrust bearings and automatic braking. Includes rotator, controller, remote control, clamps, hardware.

**AR-500** \$169.95  
12 Memories. Digital display. 110/220 VAC.

## Motorized Butterfly Capacitors

Super low loss butterfly capacitors, no rotating contacts, all plates welded with no mechanical electrical contacts. Anti-backlash mechanism. DC motor with gear reduction box. Handles at least 150 Watts SSB/CW/Digital.

**1. p/n: 282-1786, \$189.95.** 11-128 pF.

**2. p/n: 282-1788, \$249.95.** 15-260 pF.

**3. p/n: 80-1786-2SM, \$249.95.** Auto band selecting remote controller with SWR/Wattmeter.

**4. p/n: 80-1782-2, \$79.95.** Manual remote control, fast/slow tune buttons.

## Butterfly Capacitors

**5. MFJ-19, \$79.95.** 12-67 pF.

**6. MFJ-23, \$109.95.** 18-136pF.

**7. p/n: 729-0142, \$19.95.** 6:1 vernier gear reduction drive for loop tuning capacitor.

**8. 36-inch Aluminum Circular Loop with Integrated welded capacitor and mast mounting brackets** p/n: 10-1786-11, \$129.95. 1.05 inch OD heavy duty tubing.



## MFJ Low-Noise Receiving Mag Loop

Clearly hear signals 50 KHz to 30 MHz you never knew existed. Power line noise and static disappears. Rotating MFJ-1886 eliminates interfering signals or greatly peaks desired signals. Excellent antenna and preamplifier balance gives deep null. Gives excellent strong and weak signal performance without overload. Fully protected state-of-the-art push-pull Gali MMICs preamplifier gives you high dynamic range, low IMD and 25 dB of low noise gain. Use inside or outside.



## MFJ Tripods/Masts

Strong, black steel triangular braced base. Non-skid feet, strong mast locks. **MFJ-1919, \$109.95,** Supports 100 lbs. Extends a whopping 7.8 ft. Base spreads up to 4.8 sq. ft. 1.4" dia. mast. Collapses to 54" by 6" diameter. 9 3/4 lbs. **MFJ-1919EX, \$179.95.** Tripod plus mast. 18' extended. 5' collapsed. 1/8" wall, 3/4" dia. top, 1 1/2" dia. bottom. 15 lbs. **MFJ-1918, \$69.95,** 6' extended. 38" collapsed, 6 3/4 lbs. **MFJ-1918EX, \$109.95.** Small tripod with extension mast. 9 1/2', 3.8 ft. collapsed. 3/4" top, 1" bottom. 6.5 lbs.



MFJ Enterprises, Inc. 300 Industrial Pk Rd, Starkville, MS 39759

Phone: (662) 323-5869 • Tech Help: (662) 323-0549 • FAX: (662) 323-6551 8-4:30 CST, Mon.-Fri.

Add shipping. Prices and specifications subject to change. (c) 2017 MFJ Enterprises, Inc.

• 1 Year No Matter What™ warranty • 30 day money back guarantee (less s/h) on orders direct from MFJ



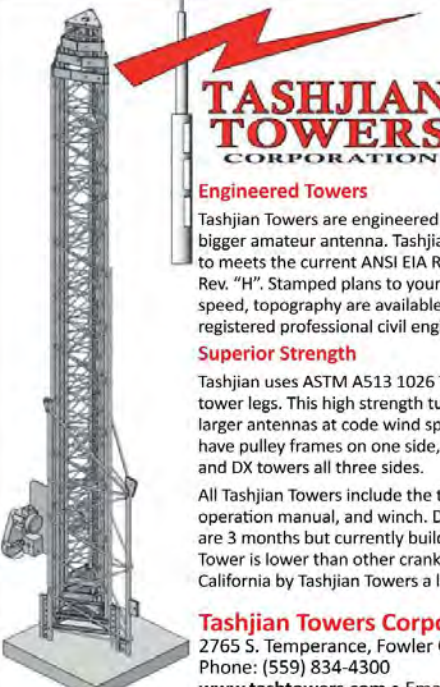

**TASHJIAN TOWERS CORPORATION**

**Engineered Towers**

Tashjian Towers are engineered to hold today's bigger amateur antenna. Tashjian Towers are rated to meet the current ANSI EIA RS 222 Standard, Rev. "H". Stamped plans to your specific wind speed, topography are available by experienced registered professional civil engineers.

**Superior Strength**

Tashjian uses ASTM A513 1026 Type 5 tubing for tower legs. This high strength tubing allows for larger antennas at code wind speeds. W towers have pulley frames on one side, LM tower 2 sides, and DX towers all three sides.

All Tashjian Towers include the tower base, an operation manual, and winch. Delivery or lead time are 3 months but currently building towers to ship from stock. Cost to ship a Tashjian Tower is lower than other crank up tower manufacturers. Installation is available in California by Tashjian Towers a licensed contractor in Ca.

**Tashjian Towers Corporation** (Formerly Tri-Ex Towers Corp.)  
 2765 S. Temperance, Fowler Ca 93625  
 Phone: (559) 834-4300  
[www.tashtowers.com](http://www.tashtowers.com) • Email [Norman@tashtowers.com](mailto:Norman@tashtowers.com) for personalized service

Tower Model	Antenna Area EIA H 100 MPH	Price 2018
MW-33	45	\$4,350
WT-51	12	\$3,550
WT-67	11	\$5,800
LM-237	20	\$2,800
LM-354	18	\$5,050
LM-354HDSP	45	\$9,050
LM-470	24	\$10,200
LM-584	13	\$10,950
DX-70	45	\$15,300
DX-70HD	70	\$22,450
DX-86	26	\$16,450
DX-86HD	38	\$24,100
DX-100	24	\$28,500
DX-100HD	40	\$31,500
TM-370HD	28	\$12,350
TM-490HD	42	\$16,600
TM-5100HDR	32	\$26,750

**RF Connectors & Adapters**

[www.W5SWL.com](http://www.W5SWL.com)

**THE WIREMAN, INC™**

**"CERTIFIED QUALITY"**

**800-727-WIRE (9473)**

Still, going strong after 35 years! The "Keywords" for "Certified Quality" Wire, Cable, Connectors, Accessories, and customer service. See it all at [www.thewireman.com](http://www.thewireman.com)

Tech Help: 864-895-4195 or [info@thewireman.com](mailto:info@thewireman.com)

**SOUTHWEST US? Call 405-376-9473**

TOP WIREMAN dealer **CLEAR SIGNAL PRODUCTS**

[www.coaxman.com](http://www.coaxman.com) • [orders@coaxman.com](mailto:orders@coaxman.com)

**HAMMOND MANUFACTURING™**

Visit our web site for technical data, drawings, PDF catalogs and a list of stocking distributors.

**Audio, B+, Filament & Power Transformers & Inductors**

**Racks, Rack Cabinets & Accessories**

**Plastic, Die-cast & Metal Enclosures Aluminum & Steel Chassis**

[www.hammondmfg.com](http://www.hammondmfg.com)

U.S. Tel:(716) 630-7030 Fax:(716) 630-7042

Canada Tel:(519) 822-2960 Fax:(519) 822-0715

**The ARRL Repeater Directory 2020 Edition**

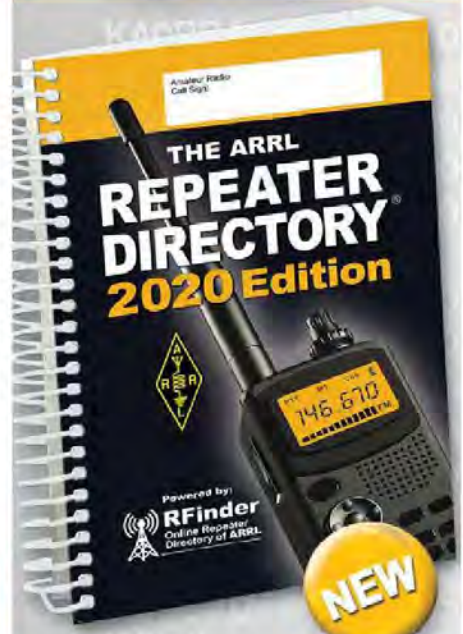

- Updated! 28,000+ listings.
  - World's largest printed directory of repeater systems.
  - Listings for US and Canada, organized by state/province, city, and operating mode.
  - Digital repeaters including FUSION, D-STAR, DMR, NXDN, and P25 systems.
  - VHF/UHF and microwave band plans included.
  - Spiral "lay flat" binding (size: 6" x 9").
  - Public service volunteers: include this printed directory with your emergency 'go kit.'
  - Make it yours! Cover includes space to personalize your directory.
- The ARRL Repeater Directory 2020 Edition**  
 ARRL Item No. 1267  
**Only \$19.95**

**Also Available:**  
**RFinder - The World Wide Repeater Directory** web service and apps. RFinder's steadily growing worldwide repeater database now includes more than 55,000 repeaters in more than 175 countries.

Subscribe.[RFinder.net](http://RFinder.net)



The national association for **ARRL AMATEUR RADIO®**  
[www.arrl.org/shop](http://www.arrl.org/shop)





# MFJ

# QRP!



MFJ-9232  
**\$69.95**

## QR Pocket™ Loop Antenna Tuner

Drape a wire around a bookcase, window, tree or other object and attach both ends to this MFJ QR Pocket™ Loop Antenna Tuner. It instantly turns into a small, high efficiency multi-band transmitting loop antenna!

Operate 40-10 Meters with included flexible wire loop (80/60 Meters with your bigger loop). No ground, radials or counterpoises needed. 25 Watts.

It's a very quiet receiving antenna. Its

VIDEOS: [https://m.youtube.com/results?search\\_query=MFJ-9232](https://m.youtube.com/results?search_query=MFJ-9232)

hi-Q reduces QRM, overload, harmonics. Perfect for apartments, antenna restricted areas and portable operation. Tune any shape loop -- circle, square, rectangle, etc.

Adjust tuning and matching capacitors for minimum SWR and operate.

BNC for transmitter, wing nut posts for loop wire. Tiny 2 1/4 Wx4 Hx2 1/4 D inches.

MFJ-9234, \$69.95. Like MFJ-9232 but connects directly to your transmitter SO-239 antenna connector.



## QRP Antenna Tuner

MFJ-9201, \$59.95. Tunes any antenna 80-10 Meters, 25 W. 12-position hi-Q inductor, tune/bypass, variable antenna and transmitting matching capacitors, BNC connectors. Tiny 4 Wx2 3/8 Hx 1 1/2 D inches -- MFJ-9201, rig and antennas easily fit into a backpack or briefcase for vacation, SOTA, hikes, etc.



## MFJ Walk-About 80-6M Antenna

MFJ-1899T, \$99.95. Perfect for QRP radios like FT-817, KX3, Xiegu, others. Covers all bands 80-6 Meters including WARC. Ten section telescoping whip (52" extended, 7" collapsed). 12" base loading coil with Wander Lead. Whip/coil unscrews for easy storage. 25Watts. BNC. MFJ-7703, \$8.95, BNC/PL-259 elbow mounts antenna directly on radio.



## MFJ Single Band Walk-Abouts

Each is 51 inches extended and collapses to 5.5 inches. Handles 25 Watts. BNC.

- MFJ-1806T (6M) \$34.95
- MFJ-1810T (10M) \$34.95
- MFJ-1812T (12M) \$34.95
- MFJ-1815T (15M) \$34.95
- MFJ-1817T (17M) \$34.95
- MFJ-1820T (20M) \$34.95
- MFJ-1830T (30M) \$44.95
- MFJ-1840T (40M) \$44.95
- MFJ-1880T (80M) \$44.95

## MFJ HF SSB Travel Radios



12-Watts, proven on-air design, hot receiver, analog S-meter, CW option, great sensitivity, 8 poles tight IF filtering, smooth VFO, powerful audio, 15, 17, 20, 40 & 75-Meter models. \$279.95

## Xiegu X5105 5W HF Transceiver

X5105, \$599.95. Mention this QST ad for \$50 off! Transmits 160-6 Meters, receives .5 - 54 MHz, all modes: USB, LSB, CW, AM, FM, digital. DSP. Built-in automatic antenna tuner, 3800 mAh battery pack, plots SWR graphically. Deluxe keypad microphone included.



## 80-10M End-Fed Half Wave Antenna

MFJ-1982LP, \$54.95. Get on the air quick! 30W, 132' wire. No tuner needed.

## 33' Telescopic Portable Mast

MFJ-1910, \$99.95. Fiberglass. 3 3/4 ft collapse, 3.3 lbs. MFJ-1979, \$69.95. Stainless steel, collapses to 27".



## MFJ Mini Switching QRP Power Supply

MFJ-4103, \$69.95. Delivers reliable regulated 13.8 VDC at 2.89 Amps (40 Watts) to anywhere in the world (100-240 VAC/47-63Hz input). Over-voltage, over-current, over-temperature protected. Tiny 4 1/8 x 2 5/8 x 1 3/8", 10 oz; 2.1 mm ID, 5.5mm OD coaxial DC connector. FT-817 adapter included. MFJ-5513, \$5.95. 2.1 mm to PowerPoles™.



## MFJ 500 MHz Dummy Load

MFJ-261, \$34.95. Finned aluminum, air-cooled heatsink 50 Ohm dummy load. 100W peak, 15W average. DC to 500 MHz, 1.15:1 SWR. 1 5/8" dia. by 3" long.



## CW Straight Key

MFJ-550, \$19.95. Morse Code straight key. Adjustable spacing and spring tension. Durable plastic base with mounting holes.



## SWR/Wattmeter Dummy Load

MFJ-9218, \$54.95. Resistive SWR Meter protects output transistors with 3:1 maximum SWR when tuning your antenna. 5/10/20 Watt power ranges. Tune/Bypass switch, BNC input and output connectors. Covers 1.8 to 60 MHz. Rugged tiny case fits any where 4 1/2 Wx2 1/4 Hx2 3/4 D".



## QRP WattMeter/Dummy load

MFJ-9214, \$39.95. Check true QRP output power with this sensitive QRP Wattmeter with built-in 50 Ohm dummy load. Also tests battery condition. Reads 5W full scale 1.8-150 MHz. BNC male connects directly to your rig. 2 Wx2 1/4 Hx1 1/2 D". MFJ-7737, \$6.95. BNC female to PL-259 adaptor.



## QRP SWR/Wattmeter

MFJ-9213, \$49.95. Read SWR, forward, reflected power in three ranges: 5, 30, 100 Watts on calibrated meter scale. Bruene bridge insures uniform accuracy over 1.8-50 MHz and allows you to leave in-line for continuous monitoring without insertion loss. BNC for transmitter/antenna. 4 1/2 Wx2 1/4 Hx2 3/4 D inches.



## MFJ QR Pocket™ 4:1 Balun

MFJ-9211, \$29.95. 4:1 current balun for feeding balanced dipole/antenna to 50 Ohm coax. Binding post, BNC.



## Artificial Ground

MFJ-9231, \$69.95. Tune your counterpoise and ground to greatly increase your radiated power.



# MFJ

MFJ Enterprises, Inc. 300 Industrial Pk Rd, Starkville, MS 39759  
Phone: (662) 323-5869 • Tech Help: (662) 323-0549 • FAX: (662) 323-6551 8-4:30 CST, Mon.-Fri.

Add shipping. Prices and specifications subject to change. (c) 2020 MFJ Enterprises, Inc.

• 1 Year No Matter What™ warranty • 30 day money back guarantee (less s/h) on orders direct from MFJ



**Every Ham Needs This Essential Book!**



# Grounding and Bonding for the Radio Amateur

H. Ward Silver, NØAX

**Good Practices for Electrical Safety,  
Lightning Protection, and RF Management**

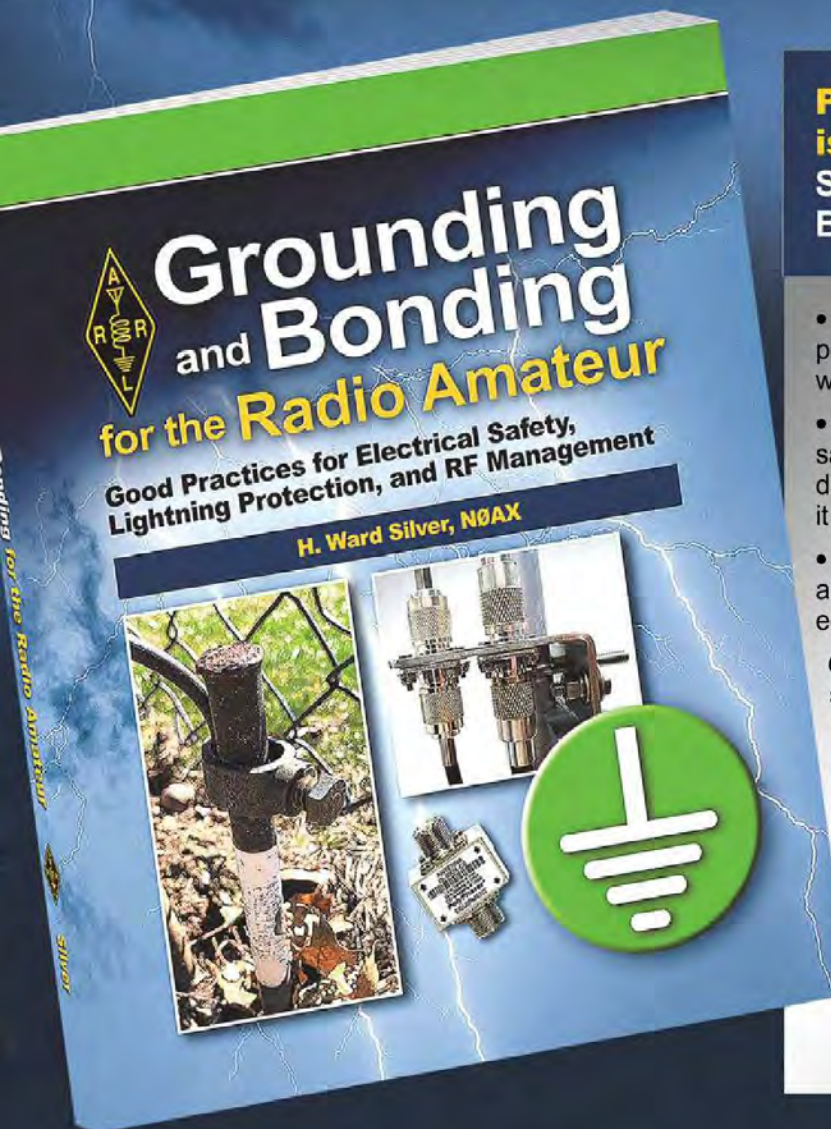

**Proper Station Grounding is Important!...Build Your Ham Radio Station with Effective Grounding and Bonding Techniques:**

- **AC safety:** protects against shock hazards from ac-powered equipment by providing a safe path for current when a fault in wiring or insulation occurs.
- **Lightning protection:** keeps all equipment at the same voltage during transients from lightning and dissipate the lightning's charge in the Earth, routing it away from equipment.
- **RF management:** prevents unwanted RF currents and voltages from disrupting the normal functions of equipment (also known as RF interference or RFI).

**Grounding and Bonding for the Radio Amateur** shows you how to make sure your station follows current standards for lightning protection and communication systems, not to mention the National Electrical Code. You'll learn effective grounding and bonding techniques for home stations, including condos and apartments, portable and temporary stations, as well as towers and outside antennas.

**Grounding and Bonding for the Radio Amateur**

ARRL Item No. 0659

**ARRL Member Price! Only \$22.95**  
(retail \$25.95)



**ARRL** The national association for  
**AMATEUR RADIO®**

[www.arrl.org/shop](http://www.arrl.org/shop)

Toll-Free US 888-277-5289,  
or elsewhere +1-860-594-0355

QST 2/2019

**MFJ...the World Leader in Ham Radio Accessories!**

# MFJ Power Supplies

**World's best and largest selection of clean, no RF hash, no RFI power supplies designed specifically for ultra-reliable ham radio communications**

**No Matter What™ Warranty**  
Every MFJ tuner is protected by MFJ's famous one year **No Matter What™** limited warranty. We will repair or replace your MFJ tuner (at our option) for a full year.

**75-Amps, \$289.95**  
**MFJ-4275MV** high-current switching power supply gives 75A max/70A continuous.

Great for ALS-500M amplifier. Adjustable output 4-16 VDC. 110/220 VAC. Binding posts, quick connects, **PowerPoles™**, cigarette lighter socket on front. Battery charger gives charging current of 20A max, 5A continuous. 9<sup>3</sup>/<sub>4</sub>"W x 5<sup>1</sup>/<sub>2</sub>"H x 9<sup>1</sup>/<sub>2</sub>"D. Only 10.5 lbs.

**45-Amps, \$169.95**  
**MFJ-4245MV** Switching power supply gives 45A surge/40A continuous. 9-15 VDC out. 85-260 VAC in. Low ripple, highly regulated. 5-way posts, cig lighter, quick connects. 5 lbs., 7<sup>1</sup>/<sub>2</sub>"W x 4<sup>3</sup>/<sub>4</sub>"H x 9D".

**25-Amps, \$119.95**  
**MFJ-4225MV** Switching power supply gives 25A surge, 22A continuous. Adjustable 9-15 VDC output, 85-260 AC input. Large 3" dual Amp/Volt meters, Binding posts, Cigarette lighter socket. 3.7 lbs. 5<sup>1</sup>/<sub>4</sub>"W x 4<sup>1</sup>/<sub>2</sub>"H x 6D inches.

**MFJ-4230MV 30 Amp, 4-16 Volts Adjustable, \$99.95 Volt/Amp Meter, 5W x 2<sup>1</sup>/<sub>2</sub>H x 6D"**  
**Ham Radio's Best Seller!**



**MFJ-4230MV** is ham radio's best selling and most compact switching power supply - just 5W x 2<sup>1</sup>/<sub>2</sub>"H x 6 D" and 3 lbs. Takes up little room at your operating position and perfect for home station, Field Day, DXpeditions, camping, hiking, or for your next business trip or vacation.

**MFJ-4230MV** gives 25 Amps continuously or 30 Amps surge at 13.8 VDC. Voltage is front-panel adjustable from 4 to 16 VDC.

**Add a pair of PowerPoles™**

**MFJ-4230MVP, \$119.95.** PowerPoles™ on back.

**MFJ-4230MPF, \$109.95.** PowerPoles™ on front.

**MFJ-4230DMP, \$159.95.** Same as MFJ-4230MVP but has bright orange LCD digital volt/amp display.



**Selectable** input voltage of 120 or 240 VAC at 47-63 Hz lets you carry it with you and use it worldwide.

**Front-panel** rocker switch lets you choose Amp or Volt meter for continuous monitoring. Cool operation with excellent 75% efficiency. Extra low ripple and noise is less than 100 mV.

**It's quiet!** Continuous air-flow gently cools the power supply and a heat sensor increases the fan speed if the temperature rises above 70 degrees celsius.

**Over-voltage** and over-current protection fully protects your transceiver and has ALARM LED. DC output is 5-way binding posts on the back so you can power your HF, VHF, UHF transceiver and accessories with ease.

**35-Amps, \$149.95**  
**MFJ-4235MV** switching power supply gives 35A surge and 30A continuous. 4-16 VDC with 1% voltage regulation, < 9 mV peak-to-peak ripple. AC input 90-125 or 200-240V. 7W x 4<sup>1</sup>/<sub>4</sub>"H x 8<sup>3</sup>/<sub>4</sub>"D, 4 lbs.

**35-Amps, \$169.95**  
**MFJ-4035MV** 19.2 lb. transformer delivers 35A max, 30A continuous. 1-14 VDC out, 110 VAC in. Highly regulated, 1% load regulation. 1 mV ripple. 5-way binding posts, quick connects. 9<sup>1</sup>/<sub>2</sub>"W x 6H x 9<sup>3</sup>/<sub>4</sub>"D.

**15-Amps, \$79.95**  
**MFJ-4115 Tiny!** 17A surge, 15A cont. 13.8 VDC. 110/220 VAC. 3<sup>3</sup>/<sub>4</sub>"W x 2<sup>1</sup>/<sub>4</sub>"H x 7<sup>3</sup>/<sub>4</sub>"D, 1.5 lb. 5-way posts. Switcher. **MFJ-4215MV, \$79.95.** 4-16 VDC, 15A surge, 13A cont., backlit volt/amp meters. 90-125V/200-240 VAC. Switcher.

**25-Amps, \$99.95**  
**MFJ-4125** gives 25A surge, 22A continuous. 13.8 VDC switching power supply has 5-way binding posts on front panel and quick connects on back. 3.5 lbs. Super compact 5<sup>1</sup>/<sub>2</sub>"W x 2<sup>1</sup>/<sub>2</sub>"H x 5<sup>3</sup>/<sub>4</sub>"D inches fits anywhere.

**25-Amps, \$109.95**  
**MFJ-4125P** gives 25A surge, 22A continuous. 13.8 VDC switching power supply front has 2 pair of **Anderson PowerPoles™** and 5-way binding posts on front. Quick connects on back. 3.5 lbs. Super compact 5<sup>1</sup>/<sub>2</sub>"W x 2<sup>1</sup>/<sub>2</sub>"H x 5<sup>3</sup>/<sub>4</sub>"D.

**28-Amps, \$99.95**  
**MFJ-4128** 28A surge, 25A cont. at 13.8 VDC. AC input voltage 85-135/170-260 VAC. 5-way binding posts, cigarette lighter socket, 7W x 2<sup>1</sup>/<sub>4</sub>"H x 7<sup>1</sup>/<sub>2</sub>"D, 4 lbs. **MFJ-4218MV, \$119.95.** 0-24 VDC, 18A@13.8/9A@24 VDC. Backlit V/A meter. 110/220 VAC.

## MFJ PowerPole™ Splitters

**MFJ-1104, \$54.95.** PowerPole™ Splitter. 30 Amp fused input. Outputs fused at 25, 10, 5A. Open fuse indicator. 2<sup>3</sup>/<sub>4</sub>"W x 3<sup>1</sup>/<sub>4</sub>"H x 1<sup>1</sup>/<sub>2</sub>"D.

**MFJ-1107, \$59.95.** 40 Amp fused binding posts input. 4 fused PowerPole™ outputs. Two 2.1 mm center positive power jacks.

**MFJ-1106, \$49.95.** One in, six out PowerPoles™ 30A total. 7 sets mating connectors included.



## MFJ High Current DC Multi-Outlet Strips

**Power multiple transceivers/accessories from a single DC power supply**

**MFJ-1118, \$99.95.** Power two HF and/or VHF rigs and six accessories from rig's 12VDC supply. 35A high-current and 15A accessory binding posts, Voltmeter, on/off switch. Master fuse, RF bypass.

**MFJ-1116, \$69.95.** Like MFJ-1118 but 15A total, 8 pairs 5-way posts. "On" LED, 0-25 VDC voltmeter.

**MFJ-1112, \$54.95.** Like MFJ-1116 but 6 pairs 5-way binding posts, no meter or switch. 12<sup>1</sup>/<sub>2</sub>"W x 2<sup>3</sup>/<sub>4</sub>"H x 2<sup>1</sup>/<sub>2</sub>"D.

**MFJ-1117, \$79.95.** High-current. Powers four HF/VHF radios simultaneously -- two at 35A each and two at 35A combined. 8W x 2H x 3D".

**MFJ-1129, \$139.95.** 10 outlets. Installed fuses: two 1A, three 5A, three 10A, two 25A, one 40A. Outlets 1, 2, 4-8 are PowerPoles™. Outlet 3 is a 35A high current binding post, outlet 9, 10 are 15A binding posts. On/off switch, 0-25 VDC voltmeter. 12<sup>1</sup>/<sub>2</sub>"W x 1<sup>1</sup>/<sub>4</sub>"H".

**MFJ-1128, \$129.95.** 12 fused PowerPoles™: three 1A, four 5A, four 10A, one 25A, one 40A. Switch. Meter.

**MFJ-1126, \$99.95.** 8 fused PowerPoles™: One 1A, three 5A, two 10A, one 25A, one 40A. Switch. Voltmeter. 9W x 1<sup>1</sup>/<sub>4</sub>"H x 2<sup>3</sup>/<sub>4</sub>"D".

**MFJ-1124, \$79.95.** Four pairs 35A PowerPoles™, two pairs 35A high current binding posts.



**MFJ Enterprises, Inc.** 300 Industrial Pk Rd, Starkville, MS 39759  
Phone: (662) 323-5869 ■ Tech Help: (662) 323-0549 ■ FAX: (662) 323-6551 8-4:30 CST, Mon.-Fri.



Add shipping. Prices and specifications subject to change. ©2016 MFJ Enterprises, Inc.  
• 1 Year No Matter What™ warranty • 30 day money back guarantee (less s/h) on orders direct from MFJ

MFJ\_4230MV\_110414\_QST\_090619DS

Available at:

- HRO
- Universal Radio
- R&L Electronics

*Previewed at Dayton, the new WINLINK-Certified® ARDOP Modem!*



## Navigator

The Premier Sound Card Modem!

*See QST Short Takes Review - May 2014-P. 62*

- Quiet - hear what others miss!
- Proven USB Sound Card built-in
- Precise FSK
- Genuine K1EL Winkeyer CW IC
- Complete - Six FTDI COM ports
- Universal Rig Control for every radio
- Works well with HRD, M110A, Fldigi, FT8 & many more software programs
- Front-Panel Audio & CW controls
- USB connected and powered
- Convenient - No annoying jumpers!

## New! PK-PakRatt Terminal Program for Windows

*Coming Soon!*

Tailored for:

- PK-232
- PK-900
- PK-96
- DSP-232

Run your Timewave / AEA data controller or TNC with a terminal program designed for Windows 10. One-click mode and PTT buttons, macros & more!



## PK-232SC+

Multimode Data Controller\*

- RTTY
- Packet
- Pactor
- CW
- PSK31 & all the Sound Card modes!

*\*Upgrade any PK-232 to the PK-232SC with New Lower Combo Pricing for SC & DSP Upgrade!*

Customize your PK-232 installation with our complete line of upgrades, accessories and cables.

*100,000 sold - All-time top selling data controller!*

- Single USB connection to computer
- USB Sound Card built-in
- 3-Way Rig Control built-in - logic level, RS-232 & USB!
- Computer isolated from radio
- Real FSK & AFSK
- keyboard CW - send and receive
- Dual Port - two radios at same time!



## ANC-4 Antenna Noise Canceller *See & hear a demo on YouTube!*

Kill Noise before it reaches your receiver!  
Great for suppressing power line noise, plasma TV noise & many other local electrical noises.

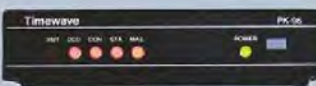

## PK-96/100 USB Packet TNC

1200/9600 bps AX.25 Packet  
Available with USB or RS-232 connection

## HamLinkUSB™ USB-to-RS-232 Adapter

Proven FTDI Chip. 9 and 25 pins for all radios, TNCs, Rotor Controllers & more!

## HamLinkUSB™ Rig Control+

C-IV, CAT, RTS (PTT, FSK or CW) for sound card software  
*Perfect for HRD owners with simple sound card adapters*

**MFJ...the World Leader in Ham Radio Accessories!**

# MFJ-4416C Super Battery Booster

**Boost battery voltage as low as 9 Volts back up to 13.8 VDC! Keeps your transceiver at full power output, compensates for run down battery, wiring voltage drop, car off...**



**MFJ-4416C**  
**\$199.95**

**Keeps** your transceiver at full power output, provides full performance, high efficiency, prevents output signal distortion and transceiver shutdown. Compensates for run-down battery, wiring voltage drop or when car is off. Provides up to 25 Amps peak with 90% efficiency. Selectable 9/10/11 Volts minimum input voltage prevents battery damage from over-discharging. RF sense turns MFJ-4416C off during receive to save power, increases efficiency and reduces noise. Adjustable 12 to 13.8 VDC output pass-through improves efficiency and lets transceiver run cooler. Has output over-voltage crowbar protection. *Anderson PowerPoles*® and high-current 5-way binding posts for DC input, regulated output. 7<sup>3</sup>/<sub>4</sub>W x 4H x 2<sup>1</sup>/<sub>8</sub>D inches. **MFJ-4416BRC, \$84.95.** Booster Remote Control.



**Super Heavy Duty Battery Booster**  
**Super** robust with heavy duty transistors, rectifier, improved switch-mode transformer, larger heatsink. Input and output EMI filters reduce noise to minimum. Rugged construction. *PowerPoles*® and 5-way binding posts. MFJ software adjusts output voltage, measure load current, set minimum voltage level, over-current trip level, ignition control, more. External boost enable, remote input/output voltage sampling, remote controllable with MFJ-4416BRC.



**MFJ-4418**  
**\$249.95**

**RFI Filter for DC power**  
**Connects** between rig and 12/24/50 VDC power supply/battery. Reduces RFI, hash, transients, motor noises, alternators, fuel pump whine, power windows, more! Binding posts/*PowerPoles*®.



**MFJ-1142**  
**\$74.95**



**MFJ-4442**  
**\$49.95**

**Digital Volt/Amp Meter**  
**Connect** in-line. Displays 4.5-30 VDC and up to 30A simultaneously. .01-.1V resolution. Dual .28" red/blue LED digits. *Anderson PowerPoles*™. Reverse polarity protection. 3 x 2 x 1".

**RFI Ferrite Chokes**  
**Suppress** RFI. Snap and locks on DC power line, coax, wires.

**MFJ-700A4**  
**\$14.95**

Effectively removes RFI and noise. Install end-to-end or loop multiple turns for more suppression. .275" hole dia. 4 in package.

**PowerPole™ DC Outlet Box**

**One** fused 30 Amp input and 25, 10, 5 Amp fused outputs with *Anderson PowerPoles*®. Has open fuse indicator. Sturdy metal construction, 2<sup>3</sup>/<sub>4</sub>W x 3<sup>1</sup>/<sub>4</sub>H x 1<sup>1</sup>/<sub>2</sub>D inches.

**MFJ-1104**  
**\$54.95**

**MFJ Low Pass Filter**

**High** attenuation above 40 MHz. 1.5kW, 1.8-30 MHz. SWR<1.3. Nine Chebyshev poles, *Teflon*® dielectric capacitors, high-Q inductors, ground plane shielding, RF tight.



**MFJ-704**  
**\$109.95**

**Lightning Surge Protector**

**Protect** your expensive equipment from lightning induced surges on 50 Ohm coax. Use for transceivers up to 400 Watts, 1000 MHz.



**MFJ-270**  
**\$24.95**

**MFJ 30-Amp Power Supply**

**World's** most compact 30 Amp switching power supply. Switchable Volt/Amp meter. Adjustable 4 to 16 VDC output. Select 120/240 VAC input. 5W x 2<sup>1</sup>/<sub>2</sub>H x 6D in., 3 lbs.

**MFJ-4230MV**  
**\$99.95**

**High-efficiency Loop Turner**

**Instantly** turn any wire into a small, high-efficiency multi-band transmitting loop antenna. Full 150W, 5.3-30 MHz.

**MFJ-935B**  
**\$249.95**

**Frequency Counter**

**300 Hz - 2.8 GHz.** 1 Hz resolution, 10-digit backlit LCD, signal strength bargraph, lithium battery.



**MFJ-886B**  
**\$149.95**

**MFJ Field Strength Meter**

**Relative** field-strength readings .1-500 MHz. Sensitivity control, 1<sup>3</sup>/<sub>4</sub> inch meter. 20-inch telescoping whip. Finger contact increases sensitivity.



**MFJ-801B**  
**\$39.95**

**25-1300 MHz Discone Ant**

**Receives** 25-1300 MHz. Transmits 50-1300 MHz up to 200 Watts. Test various Xmitters on one coax. 50 ft. coax, stainless steel elements.

**MFJ-1868**  
**\$79.95**

**17-foot Telescopic Whip**

**17-foot** stainless steel whip collapses to 27". Full 1/4 Wave on 20/17 Meters, 30-160 Meter operation with loading coil. Fits any standard 3/8-24 threaded mount.

**MFJ-1979**  
**\$69.95**

**Telescopic Fiberglass Mast**

**Super-strong** heavy-duty mast with *QuickClamps*™. 38 ft. ext., 6 ft. collapsed. 2<sup>1</sup>/<sub>2</sub>" OD bottom, 1" OD top. .125" thick wall. Supports "real" weight.

**MFJ-1906HD**  
**\$249.95**

**Giant 2<sup>1</sup>/<sub>2</sub> inch LED Clock**

**Giant** 2<sup>1</sup>/<sub>2</sub> inch super bright LEDs - see from across the street day or night. 12/24 switch, 110VAC, 9V battery backup.



**MFJ-117**  
**\$49.95**  
New Low Price!

## MFJ 2-Position Remote Antenna Switch

**MFJ** 2-position *remote* antenna switch uses a *single* coaxial feedline to feed two antennas, DC power and control signals. Remotely switch HF and/or VHF antennas. Covers 1.8 MHz to 150 MHz and handles 1500 Watts. Impedance is 50-75 Ohms. Compact 4W x 2<sup>5</sup>/<sub>8</sub>H x 1<sup>1</sup>/<sub>2</sub>D". *Outside Switch Box* is fully enclosed and weather protected. Three quality *Teflon*® SO-239 connectors for transmitter, antenna one and antenna two. Stainless steel 1<sup>1</sup>/<sub>2</sub>" tall bracket with a U-bolt for masts up to 1<sup>1</sup>/<sub>2</sub> in. O.D. *Inside biastee* control is 2<sup>1</sup>/<sub>4</sub>W x 2<sup>1</sup>/<sub>2</sub>H x 1<sup>1</sup>/<sub>4</sub> in. Use 12 VDC or 110 VAC with **MFJ-1312D, \$19.95.**



**MFJ-4712**  
**\$89.95**

**MFJ Artificial RF Ground**

By tuning out ground wire reactance RF hot spots disappear and your rig is at actual earth ground. Improve signals by resonating a wire into a tuned counterpoise.



**MFJ-931**  
**\$129.95**



**MFJ Enterprises, Inc.** 300 Industrial Pk Rd, Starkville, MS 39759  
Phone: (662) 323-5869 ■ Tech Help: (662) 323-0549 ■ FAX: (662) 323-6551 8-4:30 CST, Mon.-Fri.

Add shipping. Prices and specifications subject to change. ©2016 MFJ Enterprises, Inc.  
• 1 Year No Matter What™ warranty • 30 day money back guarantee (less s/h) on orders direct from MFJ



# Limited Edition Multi-Volume Boxed Set

## Showcasing 80 Years of Antenna Know-How

### Features:

- 1024 pages divided into more manageable volumes.
- A handsome, hard slipcase for easy storage and access.
- Four volumes covering major topic areas:
  - Antenna Fundamentals
  - Antennas for LF/MF/HF
  - Antennas for VHF through Microwave and Specialty Antennas
  - Transmission Lines and Building Systems, and Index
- New and time-tested antenna projects across nearly any frequency or mode.
- A download code to install a fully-searchable digital edition on the printed book.

View a complete list of new projects and content at [www.arrl.org/arrl-antenna-book](http://www.arrl.org/arrl-antenna-book)

**Four-Volume Boxed Set**  
ARRL Item No. 1144  
**Only \$64.95**

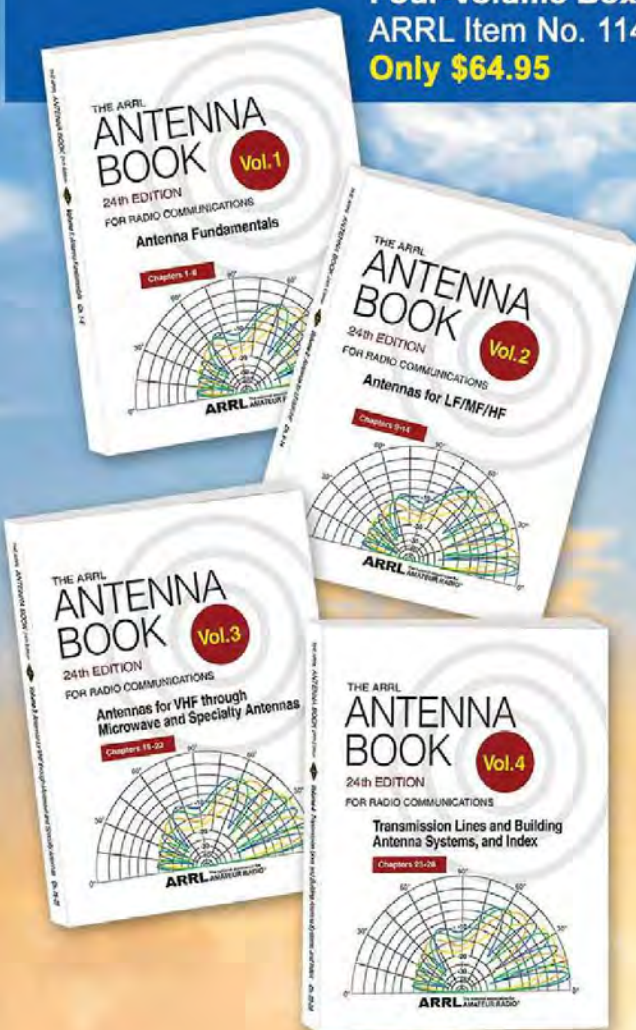
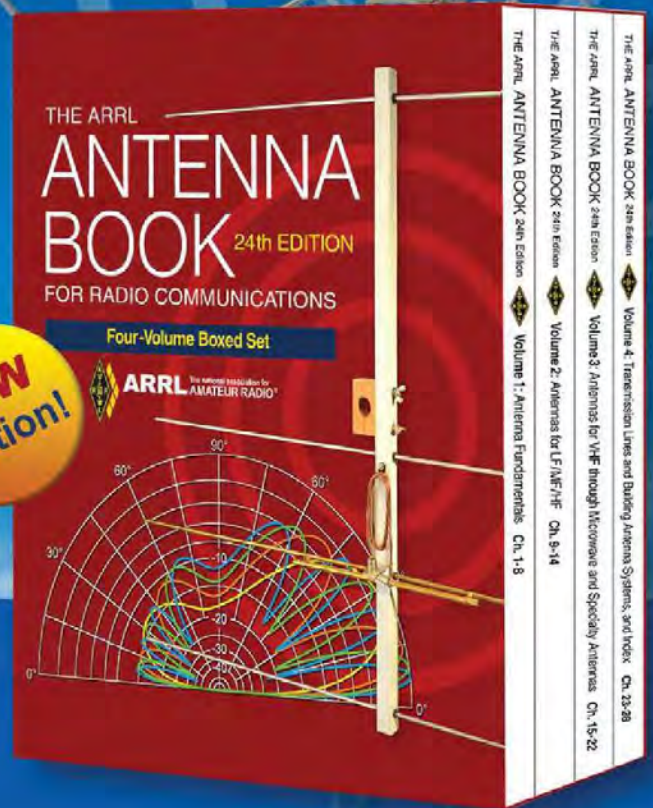

#### **Volume 1: Antenna Fundamentals**

Antenna Fundamentals  
Dipoles and Monopoles  
The Effects of Ground  
Radio Wave Propagation  
Loop Antennas  
Multielement Arrays  
Antenna Modeling

#### **Volume 2: Antennas for LF/MF/HF**

Single-Band MF and HF Antennas  
Multiband HF Antennas  
HF Yagi and Quad Antennas  
Broadside and End-Fire Arrays  
Long-Wire and Traveling-Wave Antennas  
HF Antenna System Design

#### **Volume 3: Antennas for VHF through Microwave and Specialty Antennas**

VHF, UHF and Microwave Antenna  
VHF and UHF Mobile and Rover Antennas

Antennas for Space Communications  
VHF, UHF and Microwave Antenna Systems  
Portable Antennas  
Stealth and Limited Space Antennas  
Mobile and Maritime HF Antennas  
Receiving and Direction-Finding Antennas

#### **Volume 4: Transmission Lines and Building Antenna Systems, and Index**

Transmission Lines  
Transmission Line System Techniques  
Antenna Materials and Construction  
Building Antenna Systems and Towers  
Antenna and Transmission Line Measurements  
Antenna System Troubleshooting



**ARRL** The national association for  
**AMATEUR RADIO®**  
[www.arrl.org/arrl-antenna-book](http://www.arrl.org/arrl-antenna-book)

**MFJ...the World Leader in Ham Radio Accessories!**

# MFJ 4-Band Octopus Antenna

## Choose any 4 bands: HF/VHF/UHF

**Octopus antenna hub turns your hamsticks into four fully balanced dipoles in minutes!**

**Mix and match** any four HF/VHF/UHF bands.

**Example:** screw-in 80, 40, 20 Meter hamsticks and a dual band 2M/440 MHz whip (two on each band) on opposite sides. Now you have an automatic bandswitching 5-band dipole! Rotate it for maximum signal and minimum QRM and noise with a small rotator like **Hy-Gain AR-500**, \$169.95.

**Works** at any height, low for local NVIS and high for DX. At a fixed height, (say 20-30 feet) use 80-Meters for NVIS and 20-Meters for low-angle DX.

**Mounts** on any mast up to 1-inch diameter. Use a fiberglass pole on a tripod and you're on the air!

**Perfect** for casual portable operation, limited space, HOAs, field day, camping, ARES during disasters.

**Single** coax feed, built-in balun.

**Interaction** between bands is minimized because the ends are spaced apart at a large angle.

**You don't** need an antenna tuner if you carefully tune each dipole. An easier way is to just set each dipole approximately on frequency and use an antenna tuner to operate and widen the bandwidth.

**Hamsticks** break down to about four feet for easy storage.

## MFJ 250W & 600W HamSticks

**MFJ HamSticks** are ruggedly constructed. They have a sleek, low profile construction with low wind loading. Semi-rigid fiberglass eliminates the need for springs or guys while mobile.

**Black** anti-static jacket protects loading coil and blends with any vehicle. Nearly indestructible 4 foot, 0.125 inch diameter PH-17-7 stainless steel whips are adjustable for lowest SWR. Chrome plated brass fittings will give you years of reliable service.

**Screws** into any 3/8 x 24 female mount.

**Includes** allen wrench, tuning/matching instructions.

**MFJ-16XXT HamSticks** handle 250 Watts PEP. About 7 feet fully extended, 4 feet collapsed.

**MFJ-26XXT Hi-Q HamSticks** handle 600 Watts PEP. Much larger diameter loading coil and wire gauge gives you *higher-Q*. Lower losses let you dramatically talk further and hear better. 101 inches fully extended, 53 inches collapsed.

Band	600W	Price	250W	Price
75-M	MFJ-2675T	\$69.95	MFJ-1675T	\$29.95
60-M	N/A	N/A	MFJ-1660T	\$29.95
40-M	MFJ-2640T	\$59.95	MFJ-1640T	\$21.95
30-M	N/A	N/A	MFJ-1630T	\$21.95
20-M	MFJ-2620T	\$59.95	MFJ-1620T	\$21.95
17-M	MFJ-2617T	\$49.95	MFJ-1617T	\$19.95
15-M	MFJ-2615T	\$49.95	MFJ-1615T	\$19.95
12-M	N/A	N/A	MFJ-1612T	\$19.95
10-M	MFJ-2610T	\$49.95	MFJ-1610T	\$19.95
6-M	N/A	N/A	MFJ-1606T	\$17.95
2M/440MHz	N/A	N/A	MFJ-1414	\$24.95



### Tough Octopus Hub

**Eight** 3/8 x 24 threaded connectors for hamsticks. Super strong fiberglass filled ABS base insulator. Your Octopus hub will give you years of trouble-free service!

**Based** on Geoff Haines, N1GY, award-winning December 2007 QST article.

### Super Octopus Deals

**MFJ-2104**, \$289.95 Octopus hub with 75/40/20/15 Meter 250 Watt hamsticks. Saves \$20!

**MFJ-2104H**, \$559.95 Octopus hub with 75/40/20/15 Meter 600 Watt hamsticks. Saves \$20!

**MFJ-2104X**, \$299.95 Octopus hub with your choice of four (2 each) 250W hamsticks. Saves \$20!

**Mfj-2104HX**, \$569.95 Octopus hub with your choice of four (2 each) 600W hamsticks. Saves \$20!

**AR-500**  
**\$169.95** **Antenna Rotator**  
*Rotate your Octopus dipoles for maximum gain and minimum QRM/noise!*

**Weatherproof** one piece cast aluminum housing with precision all metal gears, steel thrust bearings and automatic braking. Includes rotator, controller, remote control, clamps, hardware. Remembers up to 12 directions!

Digitally displays position.  
**110/220VAC switchable.**

### Portable Tripod with 18-foot mast

**MFJ-1919EX**  
**\$169.95**  
w/18' ext. mast

**Black steel** base forms strong braced equilateral triangles on a side. Non-skid feet and strong base and mast locks. Stays in place! Telescopic fiberglass mast with **QuickClamps™** for instant *no-tool* set-up. 18 feet extended. 5 feet collapsed. Strong 1/8" wall fiberglass, 3/4" diameter top section, 1 1/2" diameter bottom section. 15 lbs. **MFJ-1905**, \$34.95. Tripod anchor foot braces. 3-pack stainless hardware set.



**MFJ Enterprises, Inc.** 300 Industrial Pk Rd, Starkville, MS 39759  
Phone: (662) 323-5869 ■ Tech Help: (662) 323-0549 ■ FAX: (662) 323-6551 8-4:30 CST, Mon.-Fri.



Add shipping. Prices and specifications subject to change. ©2016 MFJ Enterprises, Inc.  
• 1 Year No Matter What™ warranty • 30 day money back guarantee (less s/h) on orders direct from MFJ

MFJ-2100\_100218\_QST\_092019DS



**HONDA**  
GENERATORS

New Model!  
Lowest Prices!!

# MOTOSPORTS

OF UKRAINE

"By hams, for hams" • K2HZ0 • KM6LLL

**EU2200I** 10% more powerful...  
just as light and as quiet as previous model.

**Microcomputer-controlled sine wave inverter:**  
clean sine wave— making it ideal for use with  
frequency-sensitive electrical equipment such as  
computers and radio equipment

**Eco-Throttle:** only runs at necessary speed to  
power what you are running- reduces noise and  
fuel consumption!

**Clean, Quiet, Portable power!**

(800)-832-7365  
www.hondashop.com

Free Shipping!! (in the continental 48 states) • CA residents add 7.375 tax  
Please read your Owner's Manual and all labels before operation.

## CURE RFI NOW

**RFI Kits—Home, Mobile or Portable operation**  
Audio/home theater, AM Broadcast, Marine/RV, Ham Radio,  
Consumer Electronics, Computer, Solar Systems, Garage Door,  
Grow Lights, Sprinkler, HVAC, LED, Ethernet/Cable TV/DSL

**Ferrites—Toroid Rings, Snap-on, Slip-on**  
On-line tutorials show you how to stop RFI from 100 KHz to  
2000 GHz - Group discounts, OEM, dealer, quantity pricing

**Noise Filters—reduce radio noise, work more DX**  
AC/DC power, coax noise filters, wall wart, generator

**Antenna Kits—Feed Line Chokes & Transformers**  
BULLET™ end fed antennas from QRP to Kilowatts on all bands  
Download FREE RFI Tip Sheet

Palomar-Engineers®.com  
760-747-3343

## Debco Electronics, Inc.

RF Patch  
Cables  
Coax Crimping  
& Stripping Tools  
RF Connectors  
Powerpole  
Crimpers  
and Connectors

Full Line of Crimpers &  
RF Connectors at...

www.Debcoelectronics.com

## The NEW EZ HANG Square Shot Kit

www.ezhang.com

Suggestions from thousands of  
HAM'S and Cable installers around  
the world, led to a complete  
redesign of the EZ Hang. Custom  
designed for YOU, the user in mind.  
Now safer and easier to use, you will hit your mark  
every time, with less chance of misfires hitting the  
yoke.

SEE US AT DAYTON HAMVENTION®  
MAY 15<sup>th</sup> - MAY 17<sup>th</sup>  
FOR A GREAT DEAL!

\$99.95 + \$9.05 for shipping when paying by check

304-856-1026

www.ezhang.com

EZ HANG

75 Goldfinch Way  
Capon Bridge, WV 26711



www.SwapMyRigs.com  
Modular Rig VGA-Cable Mobile Separation Kit



Swap rigs without ever changing cables.  
One cable replaces three regardless of make or model.  
\$89.99 complete with 15' VGA cable.  
AE4S, LLC

## Radio Direction Finder

KN2C DF2020T Kit

Useful for 100~1000MHz

Map Plotting Program  
On Google Earth™  
with GPS Data

On Sale \$398  
www.kn2c.us

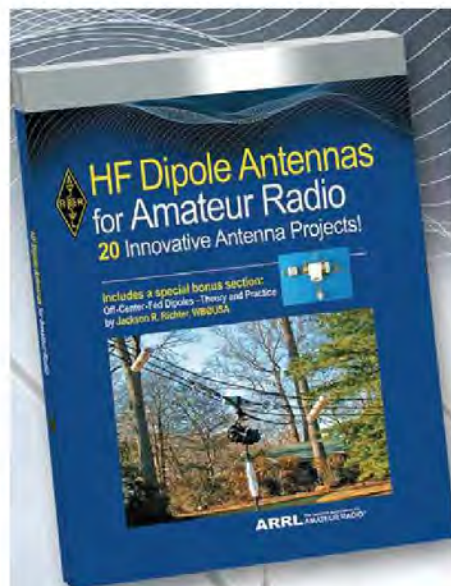

ARRL's **HF Dipole Antennas for Amateur Radio** is a collection of 20 HF dipole antenna designs published in QST, between 2000 and 2017. It includes innovative antenna projects for single- and multiband antennas, as well as antennas for portable applications.

### Portable Antennas

- An Easy-to-Make Three-Band Dipole for ARRL Field Day
- A Field-Portable Multi-Band Rotatable Dipole Antenna
- A Small, Portable Dipole for Field Use
- A Portable Twin-Lead 20-Meter Dipole
- The NJQRP Squirt

### Multiband Antennas

- A Shortened 60 Meter Dipole That Also Covers 15 Meters
- A Compact Multiband Dipole
- A Folded Skeleton Sleeve Dipole for 40 and 20 Meters
- A Fan Dipole for 80 through 6 Meters
- A No Compromise Off-Center Fed Dipole for Four Bands
- Six Band Loaded Dipole Antenna
- The Classic Multiband Dipole
- A Dipole Curtain for 15 and 10 Meters
- K8SYL's 75 and 10-Meter Dipole
- The N4GG Array

### Single-Band Antennas

- A Lightweight Rotary Dipole for 40 Meters
- The WØIH Tunable 80 Meter Dipole
- A Coaxial Cable Vertical Dipole Antenna
- A Wideband Dipole for 75 and 80 Meters
- The K4VX Linear-Loaded Dipole for 7 MHz

Includes a Special  
Bonus Section:  
Off-Center-Fed Dipoles  
— Theory and Practice

**HF Dipole Antennas  
for Amateur Radio**  
ARRL Item No. 0994  
**ARRL Member Price!**  
Only \$19.95 (retail \$22.95)



The national association for  
**ARRL AMATEUR RADIO®**  
www.arrl.org/shop

QST 5/2019

**MOSLEY ANTENNAS**  
...built to last!

AIRCRAFT GRADE ALUMINUM  
ELEMENTS & BOOMS and  
STAINLESS STEEL HARDWARE

**STRONG!**

AVERAGE IN USE  
LIFE OF 27+ YEARS  
WITHOUT MAINTENANCE

# Mosley

... "a better Antenna!"

**COMMAND YOUR BAND  
WITH A MOSLEY!**

Call 800-325-4016  
to REQUEST A CATALOG or E-mail from our Website

SHOP Mosley designs at [www.mosley-electronics.com](http://www.mosley-electronics.com)



**MFJ...the World Leader in Ham Radio Accessories!**

# MFJ Analyzers

## MFJ-259D...World's Most Popular Antenna Analyzer!

MFJ-259D  
**\$319.95**

**Super easy-to-use!**

Dual analog meters, LCD - **New and improved, now covers 280 KHz-230 MHz plus 2200 Meter band!**



**World famous** MFJ-259D gives you a complete picture of your antenna's SWR and Complex Impedance.

**MFJ-259D** is a complete ham radio test station including - frequency counter, RF signal generator, **SWR Analyzer™**, RF Resistance/Reactance Analyzer, Coax Analyzer, Capacitance/Inductance Meter and more!

**You** can read Complex Impedance as series resistance and reactance (R+jX) or as magnitude (Z) and phase (degrees).

**Determine** velocity factor, coax cable loss in dB, length of coax and distance to short/open.

**You** can read SWR, return loss and reflection coefficient at any frequency simultaneously.

**MFJ No Matter What™ Warranty**

Every MFJ Analyzer is protected by MFJ's famous one year **No Matter What™** limited warranty. We will repair or replace your MFJ analyzer (at our option) for a full year.

**Read** inductance (uH) and capacitance (pF) at RF frequencies.

**Large** easy-to-read two line LCD screen and side-by-side meters clearly display your information.

**Built-in** frequency counter, Ni-MH/Ni-CD charger circuit, battery saver, low battery warning, smooth reduction drive tuning.

**Super** easy to use! Just set the bandswitch and tune the dial - just like your transceiver. SWR and Complex Impedance are displayed instantly!

**Fully** portable, take it anywhere - remote sites, up towers, on DX-peditions. Use 10 AA or Ni-Cad or Ni-MH batteries (not included) or 110 VAC with **MFJ-1312D**, \$19.95. Rugged metal cabinet only 4 x 2 x 6 3/4 inches.

**MFJ-249D, \$299.95.**

If digital display is all you need MFJ-249D does everything MFJ-259D does without analog meters.



## More hams use MFJ analyzers than all others in the world!

**MFJ-269D**

280 KHz - 230 MHz plus 415-470 MHz, 1-60 MHz Color Graphic 280-230 MHz plus 2200Meters!

**MFJ-269D**

**\$419.95**

**NEW!**

**MFJ-269D** is a *super* MFJ-259D that adds 415-470 MHz and 12-bit A/D converter that gives you much better accuracy. **Complex Impedance Analyzer** reads series/parallel equivalents and magnitude/phase **CoaxCalculator™** gives line length from electrical degrees and vice-versa for any frequency, Velocity Factor, coax loss in dB. Use any characteristic impedance 10-600 Ohms. Has LCD log SWR bargraph, N-connector.



**MFJ-223**

1-60 MHz Color Graphic VNA Analyzer

**MFJ-223**

**\$339.95**

This *pocket-sized* wonder breaks the mold for analyzer design with user-friendly convenience, top notch accuracy, and a vivid TFT multi-color display. Don't let the size fool you, MFJ-223 is packed with all the VNA features and performance you need!

- **Single-frequency** and **swept-frequency** operating modes
- **Truly accurate** SWR, R, X, and Z measurements
- **Seamless DDS** coverage with 280-Hz resolution from 1-60 MHz
- **Smooth "skip-free"** encoder tunes fast or slow without missing a step
- **Powerful +5-dBm** stimulus generator overrides local interference
- **Field-strength meter** measures local signals, detects potential interference
- **DDS generator** precision signal source
- **Vivid 1600-pixel/inch** color graphics on a 2x2 inch non-glare TFT screen



**MFJ-225**

1.5-180 MHz continuous Two-Port Graphic Analyzer

**Out** in the field, MFJ-225 is a compact completely **self-contained handheld graphing analyzer**. On the bench it becomes a full-fledged two-port (S21) desktop machine when teamed up with your PC. Using powerful IG-miniVNA freeware, you'll run detailed data analysis and print out stunning color-graphic plots to document your work!



**MFJ-225**  
**\$339.95**

Built-in back-lighted **3-inch LCD graphic** display. Make fine adjustments using full-screen easy-to-view SWR bargraph, capture vivid swept displays for SWR, impedance, return loss, phase angle, more. DDS generator.

**MFJ-269DPRO™ Analyzer**

**MFJ-269DPro, \$459.95**

Like MFJ-269D, but UHF range covers **430 to 520 MHz** to include commercial and industrial frequencies. Rugged protective shell protects knobs, switches, meters, digital display for commercial, industrial and lab work.



### MFJ VNA Antenna Analyzer

**MFJ VNA Antenna Analyzer covers 1 to 230 MHz, 1Hz resolution.**

**Frequency sweep plots:** SWR, Impedance, Resistance, Reactance, Phase Angle, Complex Return Loss, Smith Chart  
**Sign of reactance** positively identifies inductive or capacitive reactance  
**Amazing accuracy with OSL (Open-Short-Load) calibration** - calibrate through feedline/test cable at different frequencies and store in memory. Measure directly or through feedline with exceptional accuracy, correcting for line loss/phase angle. **Smith Chart** plots S11 magnitude/phase over any frequency span. **Capture screens** in 32 memories to download to PC via USB.



**MFJ-226**  
**\$359.95**

### MFJ SWR Analyzer Accessories

- MFJ-29D/MFJ-39D, \$39.95.** Carrying Pouch for MFJ-259D/269D.
- MFJ-92AA10, \$39.95.** 10-Pack 2500 mAh Ni-MH Supercells.
- MFJ-66C, \$39.95.** Dip coils, set of two covers 1.8-230 MHz.
- MFJ-731, \$119.95.** Tunable Analyzer Filter, 1.8-30 MHz, for strong RF fields.
- MFJ-917, \$39.95.** 1:1 Current balun for SWR Analyzers to test balanced line antennas, other loads.
- MFJ-5510, \$15.95.** 12VDC cigarette lighter adapter.
- MFJ-7737, \$9.95.** PL-259 to BNC Female.
- MFJ-7727, \$9.95.** PL-259 to SMA Female.



**MFJ Enterprises, Inc.** 300 Industrial Pk Rd, Starkville, MS 39759

Phone: (662) 323-5869 ■ Tech Help: (662) 323-0549 ■ FAX: (662) 323-6551 8-4:30 CST, Mon.-Fri.

Add shipping. Prices and specifications subject to change. ©2016 MFJ Enterprises, Inc.  
• 1 Year No Matter What™ warranty • 30 day money back guarantee (less s/h) on orders direct from MFJ



# Ham Radio: Where Hands-On Lives On!

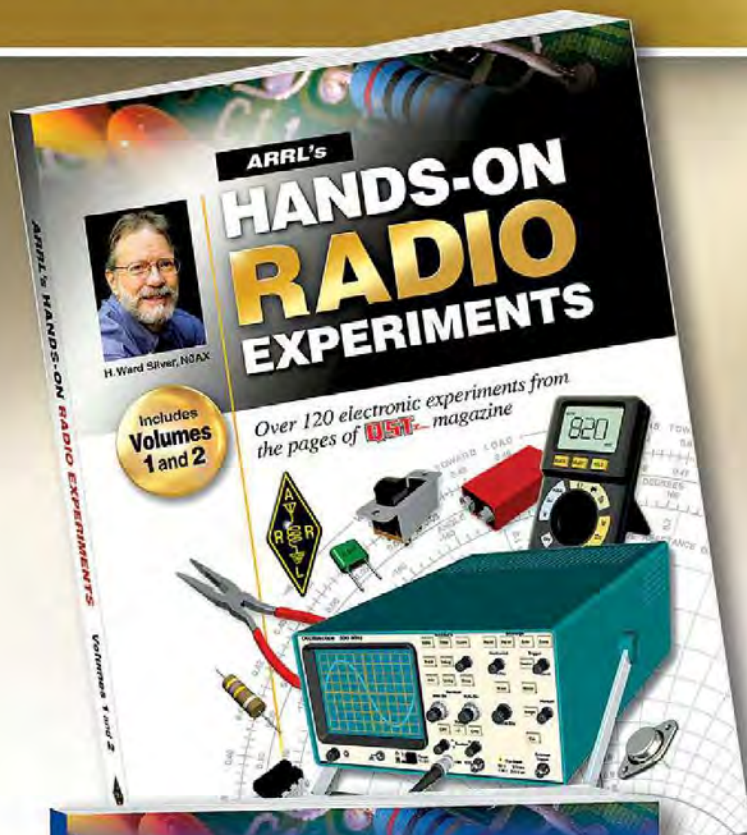

*"As long as we keep putting our hands on radios, there will be new things to learn and techniques to try!"*

## ARRL's Hands-On Radio Experiments

Each volume features short electronics experiments, designed to increase your understanding of basic radio fundamentals, components, circuits and design. The experiments, devised by Ward Silver, N0AX, first appeared in QST magazine's "Hands-On Radio" column. The collection covers a wealth of topics designed to educate today's radio experimenters, and inspire others who want to learn what makes their radios work. Even seasoned experts will encounter new approaches to practical methods, new explanations for familiar topics and new ideas that will enhance your understanding of the radio art. Step by step, Silver expertly leads you through each experiment—and you'll make discoveries along the way!

## ARRL's Hands-On Radio Experiments Volume 1 and 2

ARRL Item No. 0857

**Both Vol. 1 and Vol. 2 for Only \$29.95**

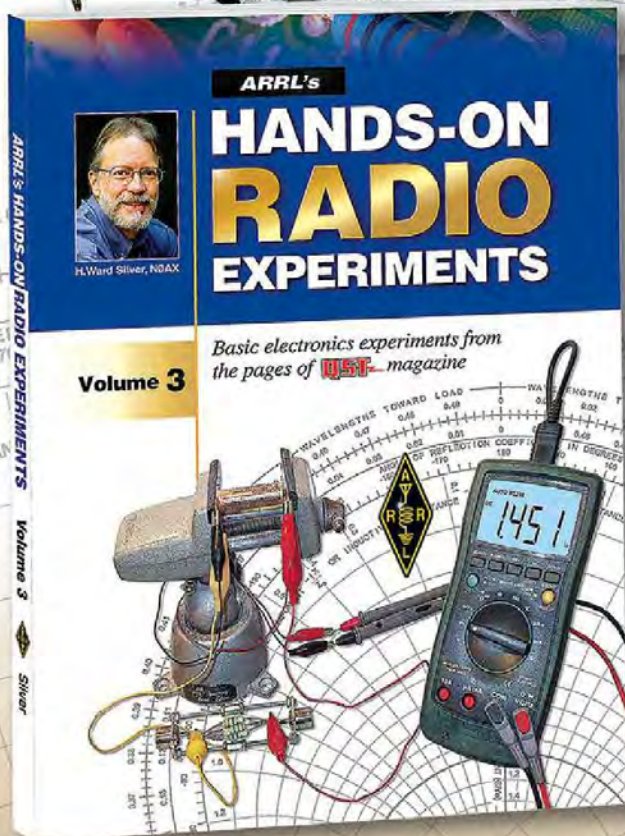

## ARRL's Hands-On Radio Experiments Volume 3

ARRL Item No. 0796

**Member Price! Only \$19.95**  
(retail \$22.95)



**ARRL** The national association for  
**AMATEUR RADIO®**

[www.arrl.org/shop](http://www.arrl.org/shop)

Toll-Free US 888-277-5289,  
or elsewhere +1-860-594-0355

QST 11/2019



**MFJ...the World Leader in Ham Radio Accessories!**

# MFJ IntelliTuner™ Automatic Tuners

**More hams use MFJ tuners than all other tuners in the world!**  
 World's most advanced Automatic Antenna Tuners feature world renowned MFJ AdaptiveSearch™ and AutomaticRecall™ algorithms – world's fastest ultra-wide range tuning. Nine World Class models!  
 Choose your features: Digital/Analog/Audio SWR-Wattmeter, Antenna Switch, Balun, Radio Interface, Digital Frequency Readout, Remoteable, Coax/Balanced Lines/Wire Tuning, Field Upgradeable...

## MFJ IntelliTuner™ Automatic Tuners

The MFJ-993B IntelliTuner™ lets you tune any antenna automatically – ultra fast.

It's a comprehensive automatic antenna tuning center complete with SWR/Wattmeter, antenna switch for two antennas and 4:1 current balun for balanced lines.

MFJ's exclusive IntelliTuner™, Adaptive Search™ and Instant Recall™ algorithms give you ultra fast automatic tuning with over 20,000 VirtualAntenna™ Memories.

You get a highly efficient L-network, 6-1600 Ohm matching at 300 Watts SSB/CW or extra wide 6-3200 Ohm matching at 150 Watts SSB/CW, 1.8-30 MHz coverage, Cross-Needle and digital meters, audio SWR meter, backlit LCD, remote control port, radio interface, heavy-duty 16 amp/1000V relays.

The MFJ-993B automatically tunes for minimum SWR and remembers your frequency and tuner settings. The next time you operate on that frequency and antenna, these tuner settings are instantly restored and you're ready to operate in milliseconds! 10W x 2 3/4 H x 9D". Use 12-15 VDC/1 amp or 110 VAC with MFJ-1316, \$29.95. Radio interface cables, remote control available. See [www.mfjenterprises.com](http://www.mfjenterprises.com)



**MFJ-993B**  
**\$339.95**

### 600 Watt MFJ Automatic Tuner



**MFJ-994B \$379.95**

Like MFJ-993B but handles 600 Watts SSB/CW, matches 12-800 Ohms. 10,000 memories. Does not have LCD display, antenna switch, 4:1 current balun, audio SWR meter/feedback. 10W x 2 3/4 H x 9D in.

### No Matter What™ Warranty

Every MFJ tuner is protected by MFJ's famous one year **No Matter What™** limited warranty. We will repair or replace your MFJ tuner (at our option) for a full year.

### 1500 Watt Legal Limit

For Ameritron  
 AL-1500/1200/82 amps



**MFJ-998 \$739.95**

Roam the entire HF spectrum 1.8-30 MHz hands-free with full 1500 Watt legal limit on SSB/CW and near-perfect SWR! Lighted LCD/Cross-Needle Meter.

### 300 Watt Extra Wide Range

SWR/Wattmeter,  
 10000 VA Memories



**MFJ-991B \$259.95**

Extra-wide matching range at less cost. Exclusive dual power level: 300 Watts/6-1600 Ohms; 150W/6-3200 Ohms. Cross-Needle SWR/Wattmeter.

### 200 Watt Compact

Digital Meter, Ant Switch,  
 Wide Range



**MFJ-929 \$269.95**

World's fastest compact auto tuner uses MFJ Adaptive Search™ and InstantRecall™ algorithms. 132,072 tuning solutions instantly match virtually any antenna with near perfect SWR.

### 200 Watt MightyMite™

Matches IC-706, FT-857D, TS-50S



**MFJ-939KIY \$169.95**

No extra space needed! Just set your IC-706/7000, FT-857D, TS-50S on top of this matching low-profile automatic tuner – it's all you need for a completely automated station using any antenna! Just tune and talk!

### 200W... Weather-sealed

For Remote/Outdoor/Marine



**MFJ-926B**  
**\$329.95**

Fully weather-sealed for remote Outdoor/Marine use! Tough, durable, built to last the elements for years.

### G5RV Antenna

**MFJ-1778 \$69.95**



Covers all bands, 160-10 Meters with antenna tuner. 102 ft. long. Can use as inverted vee or sloper. Use on 160 Meters as Marconi. 1500 Watts. Super-strong fiberglass center/feetpoint insulators. Glazed ceramic end insulators. All hand-soldered connections. Add coax, some rope and you're on the air! **MFJ-1778M, \$59.95.** G5RV Junior. Halfsize, 52 ft. 40-10M with tuner, 1500 Watts.



MFJ Enterprises, Inc. 300 Industrial Pk Rd, Starkville, MS 39759

Phone: (662) 323-5869 ■ Tech Help: (662) 323-0549 ■ FAX: (662) 323-6551 8-4:30 CST, Mon.-Fri.

Add shipping. Prices and specifications subject to change. ©2016 MFJ Enterprises, Inc. 1 Year No Matter What™ warranty • 30 day money back guarantee (less s/h) on orders direct from MFJ



# The EVENT HORIZON OF DX TS-990S

Dual TFT Display & Dual Receiver HF/50 MHz Transceiver



The main receiver has an IP3 in the +40 dB class, and the sub-receiver is the already famous TS-590S receiver. Capable of receiving two signals at once, on different bands. 7-inch and 3.5-inch color TFT displays allow displaying of independent contents. Simplification of complex operations at a glance. Make no mistake, this is not a toy. Finally a serious tool is available for getting the very most from your hobby - of course it's a Kenwood.

- Covers the HF and 50 MHz bands.
- High-speed automatic antenna tuner.
- USB, Serial and LAN ports.
- Various PC applications (free software): ARCP-990 enabling PC control, ARHP-990 enabling remote control, and ARUA-10 USB audio driver.
- Clean 5 to 200 W transmit power through the 50 V FET final unit.
- Built-in RTTY and PSK.
- Three Analog Devices 32-bit floating-point arithmetic DSPs.
- DVI output for display by an external monitor (main screen display only).

**KENWOOD**

Customer Support: (310) 639-4200  
Fax: (310) 537-8235



Scan with your phone to  
download TS-990S brochure.

[www.kenwood.com/usa](http://www.kenwood.com/usa)



ISO9001 Registered  
KENWOOD Corporation

ADS#15115

**MFJ...the World Leader in Ham Radio Accessories!**

# MFJ Tuners

## Ham Radio's Most Popular 300 Watt Antenna Tuner

**More hams use MFJ-949s than any other antenna tuner in the world!**

**Why?** Because the world's leading tuner has earned a worldwide reputation for being able to match just about anything.

**Full 1.8-30 MHz Operation**

**Tune your antenna for minimum SWR!** Works 1.8-30 MHz on dipoles, verticals, inverted vees, random wires, beams, mobile whips, shortwave receiving antennas...Use coax, random wire, balanced lines. Has heavy-duty 4:1 balun for balanced lines.

**Custom inductor switch**

Custom designed inductor switch, 1000 volt tuning capacitors, Teflon<sup>®</sup> insulating washers and proper L/C ratio gives you arc-free

no worries operation up to 300 Watts PEP transceiver input power.

**The MFJ-949E inductor switch** was custom designed to withstand the extremely high RF voltages and currents that are developed in your tuner.

**8-Position Antenna switch**

Antenna switch lets you select two coax fed antennas, random wire/balanced line or dummy load through your MFJ-949E or direct to your transceiver.



**MFJ-949E \$219.95**

**Plus Much More!**

**Full size built-in non-inductive 50 Ohm dummy load, scratch-proof Lexan multi-colored front panel, 10<sup>3</sup>/<sub>8</sub> x 3<sup>1</sup>/<sub>2</sub> x 7 inches. Superior cabinet construction and more!**

**MFJ-948, \$189.95.** Econo version MFJ-949E. Has all features except for dummy load.

**Lighted Cross-Needle Meter**

**Full size 3-inch lighted Cross-Needle Meter.** Lets you easily read SWR, peak or average forward and reflected power simultaneously. Has 300 Watt or 30 Watt ranges.

**QRM-Free PreTune™**

**MFJ's QRM-Free PreTune™** lets you pre-tune your MFJ-949E off-the-air into its built-in dummy load! Makes tuning your actual antenna faster and easier.

**No Matter What™ Warranty**

**Every MFJ tuner is protected by MFJ's famous one year No Matter What™ limited warranty. We will repair or replace your MFJ tuner (at our option) for a full year.**

## More hams use MFJ tuners than all other tuners in the world!

**MFJ-989D Legal Limit Tuner**



**MFJ-989D \$469.95**

**New, improved MFJ-989D legal limit antenna tuner** gives you better efficiency, lower losses and a new true peak reading meter. Easily handles full 1500 Watts SSB/CW, 1.8-30 MHz, including MARS/WARC bands. Six position antenna switch, dummy load. New 500 pF air variable capacitors. New improved AirCore™ Roller Inductor. New high voltage current balun. New crank knob. 12<sup>7</sup>/<sub>8</sub>W x 6H x 11<sup>5</sup>/<sub>8</sub>D inches.

ter efficiency, lower losses and a new true peak reading meter. Easily handles full 1500 Watts SSB/CW, 1.8-30 MHz, including MARS/WARC bands. Six position antenna switch, dummy load. New 500 pF air variable capacitors. New improved AirCore™ Roller Inductor. New high voltage current balun. New crank knob. 12<sup>7</sup>/<sub>8</sub>W x 6H x 11<sup>5</sup>/<sub>8</sub>D inches.

**MFJ-986 Two knob Differential-T™**



**MFJ-986 \$419.95**

**Two knob tuning (differential capacitor and AirCore™ roller inductor)** makes tuning foolproof and easier than ever. Gives minimum SWR at only one setting. Handles 3 KW PEP SSB amplifier input power (1.5 KW output). Gear-driven turns counter, lighted peak/average Cross-Needle SWR/Wattmeter, antenna switch, balun. 1.8 to 30 MHz. 10<sup>3</sup>/<sub>4</sub>W x 4<sup>1</sup>/<sub>2</sub>H x 15 in.

**MFJ-962D Compact kW Tuner**



**MFJ-962D \$359.95**

**A few more dollars** steps you up to a kW tuner for an amp later. Handles 1.5 KW PEP SSB amplifier input power (800W output). Ideal for Ameritron's AL-811H! AirCore™ roller inductor, gear-driven turns counter, pk/avg lighted Cross-Needle SWR/Wattmeter, antenna switch, balun, Lexan front, 1.8-30MHz, 10<sup>3</sup>/<sub>4</sub> x 4<sup>1</sup>/<sub>2</sub> x 10<sup>7</sup>/<sub>8</sub> in.

**MFJ-969 300W Roller Inductor Tuner**



**MFJ-969 \$259.95**

**Superb, AirCore™ Roller Inductor** tuning. Covers 6 Meters thru 160 Meters! 300 Watts PEP SSB. Active true peak reading lighted Cross-Needle SWR Wattmeter, QRM-Free PreTune™, antenna switch, dummy load, 4:1 balun, Lexan front panel. 10<sup>1</sup>/<sub>2</sub>W x 3<sup>1</sup>/<sub>2</sub>H x 9<sup>1</sup>/<sub>2</sub>D inches.

**MFJ-941E Super Value Tuner**



**Most for your money!** 300 Watts PEP, 1.8-30 MHz, lighted Cross-Needle SWR/Wattmeter, MFJ-941E \$169.95 8 position antenna switch, 4:1 balun, 1000 volt capacitors, Lexan front panel. 10<sup>1</sup>/<sub>2</sub>W x 2<sup>1</sup>/<sub>2</sub>H x 7D in. **MFJ-941EK, \$149.95.** Tuner Kit -- Build your own!

**MFJ-945E HF/6M Mobile Tuner**



**Extends your mobile antenna bandwidth** so you don't have to stop, go outside and adjust your antenna. Tiny 8 x 2 x 6 in. Lighted Cross-Needle SWR/Wattmeter. Lamp and bypass switches. Covers 1.8-30 MHz and 6 Meters. 300 Watts PEP. **MFJ-20, \$9.95,** mobile mount.

**MFJ-971 Portable/QRP Tuner**



**Tunes coax, balanced lines, random wire 1.8-30 MHz.** Cross-Needle Meter. SWR, 30/300 or 6 Watt QRP ranges. Matches popular MFJ transceivers. Tiny 6 x 6<sup>1</sup>/<sub>2</sub> x 2<sup>1</sup>/<sub>2</sub> in. **MFJ-971 \$149.95**

**MFJ-901B Smallest Versa Tuner**



**MFJ's smallest (5 x 2 x 6 in.) and most affordable wide range 200 Watt PEP Versa tuner.** Covers 1.8 to 30 MHz. Great for matching solid state rigs to linear amps. **MFJ-901B \$119.95**

**MFJ-902B Tiny Travel Tuner**



**MFJ-902B \$129.95**

**Tiny 4<sup>1</sup>/<sub>2</sub> x 2<sup>1</sup>/<sub>4</sub> x 3 inches, full 150 Watts, 80-6 Meters, has tuner bypass switch, for coax/random wire. MFJ-904H, \$169.95.** Same but adds Cross-needle SWR/Wattmeter and 4:1 balun for balanced lines. 7<sup>1</sup>/<sub>4</sub> x 2<sup>1</sup>/<sub>4</sub> x 2<sup>3</sup>/<sub>4</sub> inches.

**MFJ-16010 Random Wire Tuner**



**Operate all bands anywhere with MFJ's reversible L-network.** Turns random wire into powerful transmitting antenna. 1.8-30 MHz. 200 Watts PEP. Tiny 2 x 3 x 4 in.

**MFJ-16010 \$79.95**

**MFJ-9201 QRPocket™ Tuner**



**MFJ-9201 \$59.95**

**80-10 Meters, 25 Watts. 12 position inductor, tune/bypass switch, wide-range T-network, BNCs. 4W x 2<sup>5</sup>/<sub>8</sub>H x 1<sup>1</sup>/<sub>2</sub>D inches.**

**MFJ-921/924 VHF/UHF Tuners**



**MFJ-921/924 \$109.95**

**MFJ-921 covers 2 Meters/220 MHz. MFJ-924 covers 440 MHz. SWR/Wattmeter. 8 x 2<sup>1</sup>/<sub>2</sub> x 3 in.**

**MFJ-931 Artificial RF Ground**



**MFJ-931 \$129.95**

**Eliminates RF hot spots, RF feedback, TV/RFI, weak signals caused by poor RF grounding. Creates artificial RF ground or electrically places far away RF ground directly at rig. MFJ-934, \$249.95, Artificial ground/300 Watt Tuner/Cross-Needle SWR/Wattmeter.**



**MFJ Enterprises, Inc.** 300 Industrial Pk Rd, Starkville, MS 39759

Phone: (662) 323-5869 ■ Tech Help: (662) 323-0549 ■ FAX: (662) 323-6551 8-4:30 CST, Mon.-Fri.

Add shipping. Prices and specifications subject to change. ©2016 MFJ Enterprises, Inc. 1 Year No Matter What™ warranty • 30 day money back guarantee (less s/h) on orders direct from MFJ



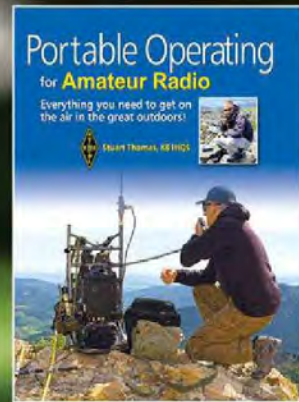
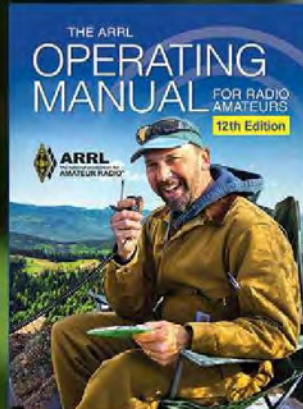
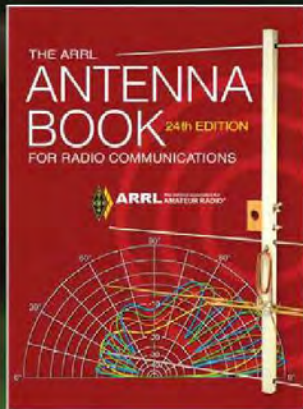

# Stay in the Know

ARRL Publications and Journals

[www.arrl.org/shop](http://www.arrl.org/shop)

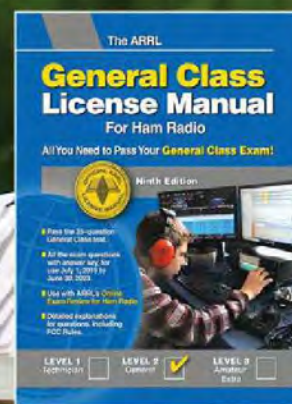
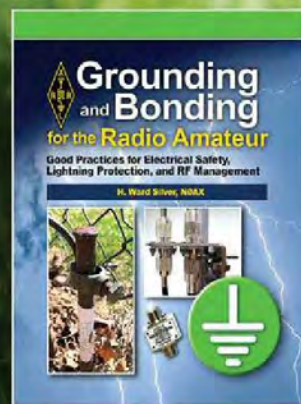
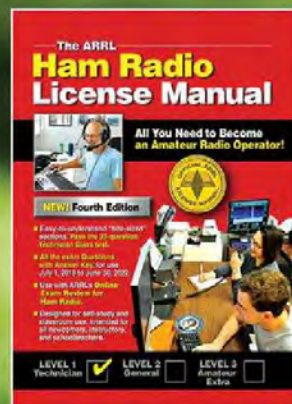

**MFJ...the World Leader in Ham Radio Accessories!**

# MFJ Dummy Loads & SWR/Wattmeters

## Dummy Loads

### World's most popular Dry 300 Watt HF/VHF Dummy Load

**Air-cooled**, non-inductive resistor in a perforated metal housing; Has SO-239 connector. Full 300W for 30 seconds. Derating curve to 5 minutes. SWR below 1.1:1 to 30 MHz, 1.5:1 30 to 650 MHz. Compact 2 1/4 x 2 1/4 x 7 inches. **MFJ-260CN, \$59.95.** With type "N" connector.



**MFJ-260C**  
**\$49.95**

### Dry 1.5 kW HF/VHF/UHF Dummy Load

**Ham radio's most versatile** 1.5 kW 50 ohm dry dummy load covers DC through 650 MHz. SWR 1.1:1 to 30 MHz and 1.3:1 to 650 MHz. Handles 1500 Watts for ten seconds, 100 Watts for 10 minutes. 3W x 3H x 9D in. SO-239 connector. **MFJ-264N, \$109.95.** With type "N" connector.



**MFJ-264**  
**\$89.95**

### Oil-Cooled 1 kW CW, 2 kW SSB 50-Ohm VersaLoad™

Run 1kW CW or 2 kW PEP for 10 minutes. Run continuous duty with 200 Watts CW or 400W PEP. Transformer oil included. SWR 1.2:1 to 30 MHz. Low SWR to 400 MHz. SO-239 connector. Safety vent with cap, carrying handle. 7 1/2H x 6 5/8D in. **MFJ-250X, \$69.95.** No transformer oil.



**MFJ-250**  
**\$79.95**

### 500 MHz, 100 Watt Dummy Load

Connects directly with built-in PL-259. Finned aluminum air-cooled heatsink. 15 Watts continuous, 100W peak. SWR <1.5:1, DC-500 MHz. 15/8 inch round by 3 inches long. **MFJ-262B, \$69.95.** PL-259. 35 Watts continuous, 200W for 5-seconds. SWR < 1.2; 1 DC-1 GHz.

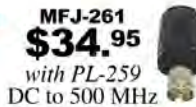

**MFJ-261**  
**\$34.95**  
with PL-259  
DC to 500 MHz

### MFJ 2500W fan-cooled Dry Load

**MFJ's** 2500 Watt fan cooled load handles legal limit amps, 2500W average one minute on, ten minutes off, 300W continuous. DC- 6 Meters. SWR <1.25, 30 MHz; <1.4, 30-60 MHz. Detailed power curve. 12 VDC or 110 VAC. 8 1/4W x 4H x 9 1/2D in. SO-239s. 5 pounds.



**MFJ-265**  
**\$249.95**

### Switchable RF Dummy Load

Select 16.6, 25, 50, 100, 150 Ohm dummy loads. Test/calibrate your wattmeters, SWR accuracy. At 50 Ohms it handles 300 Watts for 30 seconds with SWR < 1.1, 60 MHz. SO-239. 4 1/2W x 2 1/4H x 6 1/2D in. Optional 12 VDC/110 VAC adaptor. **MFJ-1312D, \$19.95.**



**MFJ-251**  
**\$169.95**

### 3 GHz, 300 Watts Dry Dummy Load

**New high-tech metal film resistor** on large heavy-duty air-cooled heatsink. 300 Watts for ten seconds and 125W continuously. SWR < 1.1, 1 GHz; <1.2, 1.5 GHz; <1.5, 3 GHz. N-connector. 10 3/4W x 2 1/4H x 5 1/4D inches.



**MFJ-263**  
**\$139.95**

### 1.5kW Dry Dummy Load/SWR/Wattmeter

**Tune** up your transceiver, linear amplifier or antenna tuner into a safe 50 Ohm dummy load at full power. Then instantly switch to your antenna and monitor SWR, forward and reflected power on lighted cross-needle meter. 300/3000 Watt ranges. DC-60 MHz. Test/tune Xceivers, amps, tuners, baluns, filters, coax, stubs.



**MFJ-267**  
**\$179.95**

## SWR/Wattmeters

### Compact Cross-Needle SWR/Wattmeters

**Large** 3-inch lighted Cross-Needle meter covers 1.8-200 MHz in 30/300W power ranges. Read forward, reflected power, SWR simultaneously. 3 1/4W x 3 1/4H x 3 1/4D in. SO-239 connectors. **MFJ-842, \$69.95.** 140-525 MHz, 15/150W.



**MFJ-822**  
**\$69.95**

### High-accuracy 1.8-60 MHz Digital SWR/Wattmeter

**Highly accurate!** Auto-ranging select 25W, 250W, 1500W ranges with full 10-bit resolution. Frequency compensated data insures highest accuracy. True peak/average forward/reflected power, SWR and frequency are simultaneously displayed on backlit LCD and large 3-inch lighted cross needle meter. Peak hold. LED, buzzer, amplifier-bypass alerts and protects your amplifier when SWR is high and toggles extra relay. 6 1/2W x 2 5/8H x 6D". **MFJ-826B, \$199.95.** No meter, ampr bypass, control relay.



**MFJ-828**  
**\$269.95**

### MFJ GrandMaster™ SWR/Wattmeters

**GrandMaster™** SWR/Power Meters are the *Cadillacs of ham radio!* Large 3 1/4 x 1 1/4 inch precision illuminated meter gives easy wide-angle viewing of SWR, forward or reflected power. 7 1/2W x 3 1/8H x 4 1/4D in. SO-239s. **MFJ-870, \$89.95.** 1.6-60 MHz. 30/300/3000 Watt ranges. **MFJ-874, \$129.95.** 1.8-525 MHz. 5/20/200 Watt ranges.



**MFJ-870**  
**\$89.95**

### MFJ giant 6.5 inch SWR/Wattmeter

**World's largest** HF+6M SWR/Wattmeter has giant 6 1/2 inch meter! Extra-long scales gives highly accurate SWR/power 1.8-54 MHz. Huge numbers make reading easy. True peak or average forward and reflected power. 20/200/2000 Watt ranges. 9 Volt battery, 12 VDC or 110 VAC with **MFJ-1312D, \$19.95.** 7W x 5 1/2H x 5D in. SO-239s.



**MFJ-868B**  
**\$179.95**

### VHF SWR/Wattmeter plus Field Strength

**World's most popular** – and most affordable – VHF SWR/Wattmeter. Read SWR, forward and reflected power over 144-220 MHz in two ranges, 30/300W. Built-in field strength meter for 1-220 MHz. 4 1/2W x 2 1/4H x 3D".



**MFJ-812B**  
**\$49.95**

### Compact Digital SWR/Wattmeters

**Displays** forward, reflected power, SWR (1.6-60 MHz) and battery all in a single glance! Large 1/2" forward power digits and 5/8" reflected/SWR digits! 0-200W. Power/backlight on/off. SO-239s. **MFJ-847, \$114.95.** 125-525 MHz, 0-120W. **MFJ-849, \$189.95.** Large 3.5" bright orange LCD displays SWR, forward/reflected power. 1.5-525 MHz, 200W, HF/VHF-UHF switch.



**MFJ-845**  
**\$114.95**



**MFJ-849**  
**\$189.95**

### MFJ HF QRP SWR/Wattmeter

**Read** forward, reflected power 1.8- 50 MHz, 0-5W. Also reads SWR, relative power 100 mW to 50W. SO-239s. 4 1/2W x 2 1/4 H x 3D in.



**MFJ-813**  
**\$49.95**

### VHF/UHF SWR/Wattmeter

**Lighted** Cross-Needle, SWR/Watts, 144/220/440 MHz, 30/300W Forward power, 6/60W Reflected power.



**MFJ-862**  
**\$79.95**



**MFJ Enterprises, Inc.** 300 Industrial Pk Rd, Starkville, MS 39759

Phone: (662) 323-5869 • Tech Help: (662) 323-0549 • FAX: (662) 323-6551 8-4:30 CST, Mon.-Fri.

Add shipping. Prices and specifications subject to change. ©2016 MFJ Enterprises, Inc. 1 Year No Matter What™ warranty • 30 day money back guarantee (less s/h) on orders direct from MFJ



# Amateur Radio: *Opening the Door to a New World for a New Generation!*

Amateur Radio opens the door to a new world of learning and exciting new possibilities. Through science and wireless technology, students are introduced to new ideas, skills, and worldwide friendship.

**ARRL's Education & Technology Program** and the **Teachers Institute on Wireless Technology** provide teachers with the necessary expertise and materials to bring Amateur Radio and wireless technology into their classrooms, helping students learn and prepare for the future. These lessons also encourage young people to become more involved in ham radio, and foster a lifelong passion for learning.

The Education & Technology program is funded entirely by member contributions. Your generous contribution is vital to the continued success of ARRL's educational programs. Please support this important effort today!



**Make your gift the easy way!** Visit [www.arrl.org](http://www.arrl.org) and click the **DONATE NOW** button.

For additional information on the **Education and Technology Fund** and the **Teachers Institute**, please visit [www.arrl.org/ETP](http://www.arrl.org/ETP) or contact Melissa Stemmer, KA7CLO, Development Manager at 860-594-0348, [mstemmer@arrl.org](mailto:mstemmer@arrl.org)





# MFJ ANTENNAS

## MFJ Wire Antennas

### G5RV -- Most popular antenna in the world!

Operate 80-10 or 40-10M with tuner. 14 gauge, 7-strand copper antenna wire. 1.5kW. 32.5' ladder line matching section with SO-239 for coax.  
**MFJ-1778, \$69.95.** 80-10M. 102 feet long.  
**MFJ-1778M, \$59.95.** 40-10M. 52 feet long.



### End Fed Half Waves

Operate 80-10 or 40-10M with one support/no tuner.

**80-10 Meters, 132 feet:**

**MFJ-1982HP, \$109.95.** 800 Watts.  
**MFJ-1982MP, \$79.95.** 300 Watts.  
**MFJ-1982LP, \$59.95.** 30 Watts.

**40-10 Meters, 66 feet:**

**MFJ-1984HP, \$89.95.** 800 Watts.  
**MFJ-1984MP, \$69.95.** 300 Watts.  
**MFJ-1984LP, \$49.95.** 30 Watts.



### Off Center Fed Dipoles

Lightweight, virtually invisible. Gives you directivity and gain (see MFJ website).

**MFJ-2012, \$89.95.** 40/20/10/6 Meters, 1500 Watts. 67 ft.  
**MFJ-2010, \$69.95.** 40/20/10/6 Meters, 300 Watts. 67 ft.  
**MFJ-2014, \$119.95.** 75/40 Meters, 1500 Watts. 122 ft.  
**MFJ-2016, \$149.95.** 160/75/40 Meters, 1500 Watts. 240 ft.  
**MFJ-2013, \$89.95.** 60/30 Meters, 300 Watts. 86 ft.



### Dual Band 80/40 or 40/20 Dipoles, 1.5 kW

**MFJ-17758, \$109.95.** 80/40 Meters, 95 feet long, ultra-efficient end-loading on 80 Meters. No tuner needed. Super-strong center insulator, built-in SO239, hanghole.  
**MFJ-17754, \$69.95.** 40/20M, 42 ft.



### MFJ All Band Doublet

**MFJ-1777, \$79.95.** 102 foot, 160-6 Meters with tuner/balun. Extremely low feedline loss. Super strong fiberglass center insulator provides stress relief for included 100 foot ladder line. Ceramic end insulators. 1500 Watts SSB/CW/Digital.



### MFJ 1.5 kW Dipoles

7-strand, 14-ga. copper wire. Ceramic insulators. Center insulator with SO-239  
**MFJ-1779C, \$39.95.** 20-6M, 35 feet.  
**MFJ-1779B, \$59.95.** 80-40M, 135 feet.  
**MFJ-1779A, \$79.95.** 160M, 265 feet.



### 20M Extended Double Zepp

**MFJ-1742, \$99.95.** See web for gain. 90 ft. long, 100 ft. ladder line. 7-strand, 14-ga. wire. 80-10M with tuner/balun. 1500 Watts SSB/CW/Digital.



### 80M End-Fed Zepp

**MFJ-1748, \$99.95.** 125 feet long, 100 foot ladder line included. 7-strand, 14-ga. wire. Use tuner/balun. 1500 Watts SSB/CW/Digital.



**MFJ-915, \$39.95**

### RFI Isolator

Prevents unwanted RF from traveling on your coax shield into your expensive transceiver. Prevents painful RF "bites" and erratic operation. 1.5 kW. 1.8-30 MHz.



**MFJ-918, \$39.95**

### 4:1 Balun

True 1:1 current balun/center insulator. High-permeability ferrite beads on RG-303 Teflon<sup>®</sup> coax. 2" dia.x6" long. 14 gauge 7-strand copper wire. 1.5 kW 1.8-30 MHz.



**MFJ-913, \$39.95, 300W**

### MFJ-919, \$69.95, 1.5 kW

True 4:1 current baluns/antenna center insulators transform 200 ohms to 50 ohms, 1.8-30 MHz. Transmission line transformer, low permeability ferrite cores, SO-239, stainless steel hardware with direct 14 gauge stranded copper wire to antenna.

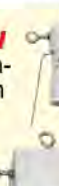

### Lightning surge protectors

**MFJ-270, \$24.95.** 400W.

**MFJ-272, \$39.95.** 1500W. Gas discharge tube shunts 5000 amps peak. < 0.1 dB loss. 1 GHz. SO-239s.



### 2-Position Antenna Switch

**MFJ-1702C, \$49.95.**

2-position antenna switch, lightning surge protection, center ground.



## MFJ Vertical Mounted Antennas

### MFJ 6-Band Cobweb Antenna

**MFJ-1836H, \$299.95.** Six-bands: 20/17/15/12/10/6 Meters, 1.5 kW. Perfect for restricted space. Nearly invisible. 9x9x1/2 feet, 8 lbs. Outstanding performance! Horizontally polarized gives less noise, more gain over verticals. Omni-directional. No radials needed! Works great at low heights. Low SWR.



**MFJ-1836, \$269.95.** Like MFJ-1836H, but 300 Watts.

### MFJ 4-Band Dipole Octopus Antenna

Octopus antenna hub turns hamsticks into four balanced HF/VHF/UHF dipoles! Rotate for maximum signal, minimum QRM/noise. Mount low for local NVIS, high for DX. Perfect for portable, limited space, HOAs, camping, ARES. Balun. No tuner needed.



**MFJ-2104, \$289.95.** Includes 8 hamsticks for 75/40/20/15 M.  
**MFJ-2100, \$119.95.** Hub only. Use eight hamsticks.

### MFJ Multi-Band Verticals, no radials needed!

Low angle radiation lets you easily work far-away, rare DX!

Efficient end loading gives maximum radiated power.

1500 Watts SSB/CW/Digital. Low SWR. Omni-directional. No radials or antenna tuner needed.

Low profiles blend into any surroundings. Mount them anywhere ground level, roof tops, apartments, houses, small lots.



Efficient high-Q coils. High power air-wound choke balun. Built-to-last. Solid fiberglass rod, aircraft aluminum tubing.

### 5 models: Choose your bands 80-2 Meters

**MFJ-1796, \$339.95.** 6 bands: 40/20/15/10/6/2M, 12 feet.  
**MFJ-1797, \$369.95.** 7 bands: 40/30/20/17/15/12/10M. 23 ft.  
**MFJ-1797LP, \$339.95.** Like MFJ-1797, but only 9 feet tall. Narrower bandwidth on 40 Meters.  
**MFJ-1799, \$449.95.** 10 bands: 80/40/30/20/17/15/12/10/6/2M. 20 ft.  
**MFJ-1799X, \$399.95.** Like MFJ-1799, but less 80M.

### MFJ 43-foot Vertical, 160-6 Meter

**MFJ-2990, \$399.95.** High performance 43 foot vertical operates 160-6 Meters, 1500 Watts SSB/CW/Digital. 2 square feet wind load. Self-supporting, no guy wires needed. 6063 aircraft aluminum tubing, bottom section 2" OD, .120" wall thickness. 20 lbs. Requires antenna tuner, ground/counterpoise.



### BigStick™ Vertical

**MFJ-2286, \$119.95.** 7-55 MHz, full 1/4 wave 20-6M, 40M coil. 17 ft. extended, 28" collapsed. 2 lbs. 1 KW. Mount, radial kit included.

### BigEAR™ Dipole

**MFJ-2289, \$209.95.** 7-55 MHz. Full-size 20-6 Meter dipole, 40M air loading coil. Two 17 ft. telescopic whips, 28" collapsed.



**MFJ Enterprises, Inc.** 300 Industrial Pk Rd, Starkville, MS 39759

Phone: (662) 323-5869 • Tech Help: (662) 323-0549 • FAX: (662) 323-6551 8-4:30 CST, Mon.-Fri.

Add shipping. Prices and specifications subject to change. (c) 2017 MFJ Enterprises, Inc.

• 1 Year No Matter What™ warranty • 30 day money back guarantee (less s/h) on orders direct from MFJ



# Introducing a NEW Member Benefit

In January 2020, we launched our newest member benefit—*On the Air* magazine aimed at helping newly licensed and beginner-to-intermediate hams navigate the world of amateur radio.



This new bimonthly publication is loaded with clear, useful information such as:

- How to select the best equipment for your interest and experience
- Tips for setting up your station & building projects
- Ways to get involved with emergency communications
- Experiences and stories of others who are getting started in amateur radio

All ARRL members will receive the digital versions of both *QST* and *On the Air*. Eligible U.S. members will be able to select one of these publications to be delivered in print.



**ARRL** The national association for  
AMATEUR RADIO®  
[www.arrl.org/join](http://www.arrl.org/join)

## Membership Application

### Membership options (circle your choice/s)

	1 Year	2 Years	3 Years	
US	\$49	\$95	\$140	Monthly <i>QST</i> or <i>On the Air</i> via standard mail for US members
Youth	\$25			Must be 21 years old or younger AND the oldest licensed Radio Amateur in the household
Canada	\$62	\$120	\$177	Monthly <i>QST</i> via standard mail for Canadian members
International	\$76	\$147	\$217	Monthly <i>QST</i> via standard mail for international members
International/Canada – no print magazine	\$49	\$95	\$140	Digital magazines only
Family	\$10	\$20	\$30	Must reside with primary member and have corresponding membership dates; no extra copies of magazines
Blind	\$10	\$20	\$30	No magazine delivery; all other member benefits apply. Requires a one time signed and dated statement of Legal Blindness.

Additional membership options are available at [www.arrl.org/join](http://www.arrl.org/join). Membership includes \$21 per year for magazine subscription. Dues subject to change without notice and are nonrefundable.

### Choose your print magazine:

- QST*, ARRL's membership journal for active radio amateurs 12 monthly issues
- On the Air – New!* For new and beginner-to-intermediate-level radio amateurs (US only) 6 bimonthly issues

Name \_\_\_\_\_ Call Sign \_\_\_\_\_

Street \_\_\_\_\_ City \_\_\_\_\_ State \_\_\_\_\_ ZIP \_\_\_\_\_

E-mail \_\_\_\_\_ Phone \_\_\_\_\_ Date of Birth \_\_\_\_\_

Family Member Name \_\_\_\_\_ Call Sign (if any) \_\_\_\_\_

### Payment Options

- Total enclosed payable to ARRL \$ \_\_\_\_\_
- Visa  MasterCard  Amex  Discover  Check Enclosed

I do not want my name and address made available for non-ARRL related mailings.

Card Number \_\_\_\_\_ Expiration Date \_\_\_\_\_

Cardholder's Signature \_\_\_\_\_



ARRL, 225 Main St.  
Newington, CT 06111

1-888-277-5289

[www.arrl.org/join](http://www.arrl.org/join)

# Quicksilver Radio

## Quality, Service & Value!

### Audio



- Adapters
- Connectors
- Cables

### Crimpers & Tools



### Crimp Kits



### Soldering Equipment



We carry soldering irons, flux, solder, digital microscopes, magnifiers and other tools for whatever project you are working on.

### Meters & Modules



### Power Supplies Batteries & Chargers



- 12V power supplies
- Variable voltage supplies
- Gel cell batteries
- Battery brackets
- Fast battery chargers

### DC Power Cables



### Power Connectors



### HAMMO-CAN™ Go Box

Ready to go, a complete VHF-UHF station in a box. New! Get them with or without radios installed. Different models available.



Building your own? Check our large selection of parts and accessories.

The Best in Ham Radio Products from  
Quicksilver Radio. Safe and Secure Ordering at:

[www.qsradio.com](http://www.qsradio.com)



Follow us on  
Facebook

# The Radio Club of Junior High School 22

Bringing Communication to Education Since 1980



## DONATE YOUR RADIO

*Radios You Can Write Off - Kids You Can't*

- Turn your excess Ham Radios and related items into a tax break for you and a learning tool for kids.
- Donate radios or related gear to an IRS approved 501(c)(3) charity. Get the tax credit and help a worthy cause.
- Equipment picked up anywhere or shipping arranged.

RC OF JHS 22 NYC  
PO Box 1052  
New York NY 10002

Call Now 516-674-4072

email: [crew@wb2jkj.org](mailto:crew@wb2jkj.org) [www.wb2jkj.org](http://www.wb2jkj.org)



# KENWOOD

## APRS® / D-STAR®

Introducing the **TH-D74A** for the ultimate in APRS and D-STAR performance.

KENWOOD has already earned an enviable reputation with the **TH-F6A** handheld transceiver. And now it has raised the bar even further with the new **TH-D74A**. While still a Tri-bander it now has a TNC, APRS, D-STAR and a GPS! With a wide band receiver it's the perfect go to radio from Prepper to Extra Class



[www.kenwood.com/usa](http://www.kenwood.com/usa)

Support/Distribution  
(310) 639-4200 Fax: (310) 537-8235

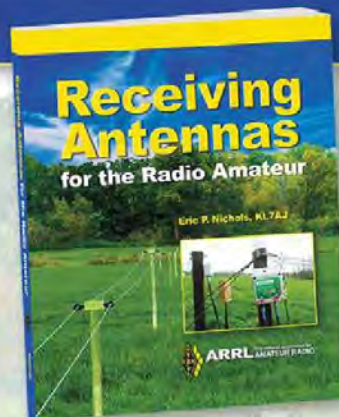

### Receiving Antennas for the Radio Amateur

A book focused entirely on active and passive receiving antennas and their associated circuits. There are few cases where you cannot benefit from a separate, well-designed receiving antenna or antenna system. On the low bands, heavy emphasis on the receiving end of these radio paths is essential for success.

ARRL Item No. 0789  
**Member Price! Only \$24.95**  
(retail \$27.95)



The national association for  
**ARRL AMATEUR RADIO®**  
[www.arrl.org/shop](http://www.arrl.org/shop)

GST 9/2018

# 2020 ARRL / TAPR

## Digital Communications Conference

September 11-13  
Charlotte, North Carolina

Make your reservations now for three days of learning and enjoyment at the Charlotte Airport Hotel. The Digital Communications Conference schedule includes technical and introductory forums, demonstrations, a Saturday evening banquet and an in-depth Sunday seminar. This conference is for everyone with an interest in digital communications—beginner to expert.

Call Tucson Amateur  
Packet Radio at:  
972-413-8277,  
or go online to  
[www.tapr.org/dcc](http://www.tapr.org/dcc)



## ABR Industries LLC

8561 Rayson Rd.  
Houston, TX 77080  
713-492-2722



[www.abrind.com](http://www.abrind.com)

## Buy With Confidence

ABR Industries manufactures all assemblies in our Houston facility, guaranteeing quality control from start to finish. Being a critical component of your system or station, it's important to know where and how your coax cable assemblies are built.

### Featured Product

#### ABR Cables with Ferrites Installed



ABR Industries now offers factory installed ferrites as an option on ABR100 (.100") to ABR600 (.590"). All cables are 100% tested and available for immediate shipment. Cores range from 1 MHz to 1 GHz. Standard Connector options are UHF, N-Type, BNC, SMA, TNC, and Mini-UHF. Custom lengths, special connector types, and special cable types are available too.

Visit us at [abrind.com](http://abrind.com) or call 713-492-2722 for questions, data sheets, or any support you may need to make the most out of your shack.

### Struggling to find the right jumper from your radio to your feedline?

**Tired of being stuck with a poorly  
made jumper that falls apart after a month?**

ABR Industries can give you the ease and confidence that you're buying the right assembly that works just as hard as you do. We can help you maximize the performance of your radio, amplifier, RF test device, or SDR. Call for advice, a quote, or check out our custom cable quote under our product information tab.

**HAM RADIO OUTLET**

**Radioworld**



**GigaParts**  
[www.gigaparts.com](http://www.gigaparts.com)

**ABR  
INDUSTRIES**

American Built & Reliable



**NEW!**

# Enjoy solid DX QSOs with the new preciseLOOP™ antenna



Ideal for portable, restricted HOA and SOTA ops. Professionally engineered and manufactured to the same high standards as our precision lab grade RF tools - 73 Roger W1RMS

- ✓ 80\* - 10 Meter bands
- ✓ Low loss LMR600\* radiator
- ✓ Copper tube induction loop
- ✓ 15 - 45 W (10W for 80M)
- ✓ Superior DX gain\* (see website)
- ✓ Quick tuning 6:1 calibrated dial
- ✓ Low loss cap PCB mounted
- ✓ Rugged compact tripod
- ✓ Deluxe carrying bag

**precise** from \$299  
45W and lighter weight 15W QRP SOTA models available

\*80M option on HG-1 model, when compared to a commercial portable dipole 20M at 10'. SOTA model uses 3/8" lighter weight Cell Flex radiator

Keep your gear in top shape with these lab grade and affordable ham radio accessories



DPM6000 60 dB dynamic range power and SWR meter



TDR Cable Radar® measure length, faults, loss & Z



50ps ultra fast pulse gen. mm TDR & rise time tests



Two-tone test gen. transmitter output quality tests



Station monitors, RF samplers, return loss bridges, directional couplers, attenuators, baluns, terminators, tuning pulsers and more



www.preciserf.com  
13690 Wisteria Dr NE, Aurora, OR 97002  
ph: (503) 915-2490

© 2017 PreciseRF & Stenbeck Enterprises LLC

## ARRL Audio News



A weekly summary of Amateur Radio news highlights in a fifteen-minute podcast, updated every Friday.

Enjoy **ARRL Audio News** anywhere: on your smart phone or tablet, your local repeater, iTunes, or stream it on the go!

[www.arrl.org/arrl-audio-news](http://www.arrl.org/arrl-audio-news)



### DTMF decoder board with eight relays



Remote control eight devices via radio audio. Password protection against unauthorized entry. Unique board ID. Comes assembled with relays. 4.5" x 2.5".

**Intuitive Circuits, LLC**

Voice: (248) 588-4400  
<http://www.icircuits.com>

**DTMF-8 \$119.00**

Visa • MC • Prepayment

# #1 Ham Radio Publications from ARRL!

[www.arrl.org/shop](http://www.arrl.org/shop)

### Advanced Specialties Inc.

"New Jersey's Communications Store"

YAESU ■ BAOFENG ■ MFJ ■ UNIDEN ■ COMET  
...and much, much more!

**HUGE ONLINE CATALOG!**  
[www.advancedspecialties.net](http://www.advancedspecialties.net)

800-926-9HAM ■ 201-843-2067  
114 Essex Street, Lodi, NJ 07644

PROMOTING THE USE OF TEN METERS SINCE 1962

### Ten-Ten International Net, Inc.

Awards - QSO Parties - Special Events - Paperchasing

NETS DAILY (except Sunday) on 28.380 and 28.800 at 1800z



**CHECK US OUT ON THE WEB**  
[www.ten-ten.org](http://www.ten-ten.org) / [www.10-10.org](http://www.10-10.org)

1349 Vernon Ter San Mateo CA 94402-3331

## Tigertronics *Signalink™* USB

When it comes to sound card interfaces, nothing beats the *Signalink USB's* combination of performance, value, and ease of use! Whether you're new to Digital operation, or an experienced user, the *Signalink USB's* built-in sound card, front panel controls, and simplified installation will get the job done right the first time—and without breaking the bank! The *Signalink USB* supports virtually all sound card digital and voice modes, and works with virtually all radios. It is fully assembled (**made in the USA!**) and comes complete with printed manual, software, and all cables. Visit our website today and see what all the buzz is about!

Operate the WSJT-X FT8 mode plus most other sound card modes including PSK31, Olivia, SSTV, RTTY, WINMOR and CW to name a few!



**(800) 822-9722**

(541) 474-6700

Order your *Signalink* today at  
[www.tigertronics.com](http://www.tigertronics.com)

Tigertronics 154 Hillview Drive Grants Pass, Oregon 97527

Janet Rocco, W1JLR, Advertising Sales Manager  
 Lisa Tardette, KB1MOI, Account Executive

# QST Index of



**Radio Adventures  
with Richard**

**New** YouTube channel  
for the more  
adventurous radio  
amateur!

New content weekly

<http://bit.ly/radio-adventures>



## Professional



SuperbHeadsets.com  
800-634-0094

Warren Gregoire & Associates, Lafayette, CA - Since 1986



**Dual Band  
2M/440  
and other  
models**

EmComm,  
Satellite work,  
long distance  
simplex and  
repeater use.

**Elk  
Antennas**  
Log-Periodic Antennas  
for the Radio Amateur  
925-330-0049  
[www.ElkAntennas.com](http://www.ElkAntennas.com)



<b>ABR Industries™</b> – <a href="http://www.abrind.com">www.abrind.com</a> .....	139
<b>Advanced Specialties</b> – <a href="http://www.advancedspecialties.net">www.advancedspecialties.net</a> .....	141
<b>Air Boss Antenna Launcher</b> – <a href="http://www.kr4loairboss.com">www.kr4loairboss.com</a> .....	113
<b>Alinco</b> – <a href="http://www.alinco.com">www.alinco.com</a> .....	21
<b>Alpha Delta Radio Communications, LLC</b> – <a href="http://www.alphadeltaradio.com">www.alphadeltaradio.com</a> .....	111
<b>Ameritron</b> – <a href="http://www.ameritron.com">www.ameritron.com</a> .....	17
<b>Arcom Communications</b> – <a href="http://www.arcomcontrollers.com">www.arcomcontrollers.com</a> .....	109
<b>Array Solutions</b> – <a href="http://www.arrayolutions.com">www.arrayolutions.com</a> .....	12
<b>ARRL</b> – <a href="http://www.arrl.org">www.arrl.org</a> .....	106, 108, 109, 111, 112, 116, 118, 120, 124, 126, 128, 132, 134, 136, 138, 139, 141, 144
<b>bhi Ltd</b> – <a href="http://www.bhi-ltd.com">www.bhi-ltd.com</a> .....	108
<b>BridgeCom Systems</b> – <a href="http://www.BridgeComSystems.com">www.BridgeComSystems.com</a> .....	Cover III, 22, 23
<b>Buckmaster Publishing</b> – <a href="http://hamcall.net">hamcall.net</a> .....	113
<b>Cable X-Perts, Inc.</b> – <a href="http://www.CableXperts.com">www.CableXperts.com</a> .....	113
<b>Cubex</b> – <a href="http://www.cubexquads.com">www.cubexquads.com</a> .....	142
<b>Cushcraft</b> – <a href="http://www.cushcraftamateur.com">www.cushcraftamateur.com</a> .....	2
<b>Debco Electronics, Inc.</b> – <a href="http://www.Debcoelectronics.com">www.Debcoelectronics.com</a> .....	126
<b>Diamond Antenna</b> – <a href="http://www.diamondantenna.net">www.diamondantenna.net</a> .....	8
<b>DX Engineering</b> – <a href="http://www.DXEngineering.com">www.DXEngineering.com</a> .....	26
<b>Elecraft</b> – <a href="http://www.elecraft.com">www.elecraft.com</a> .....	19
<b>Elk Antennas</b> – <a href="http://www.ElkAntennas.com">www.ElkAntennas.com</a> .....	142
<b>Expert Linears America, LLC</b> – <a href="http://www.ExpertLinears.com">www.ExpertLinears.com</a> .....	109
<b>EZ Hang</b> – <a href="http://www.ezhang.com">www.ezhang.com</a> .....	126
<b>FlexRadio Systems</b> – <a href="http://www.flex-radio.com">www.flex-radio.com</a> .....	25
<b>Global TSCM Group, Inc.</b> – <a href="http://www.kn2c.us">www.kn2c.us</a> .....	126
<b>Green Heron</b> – <a href="http://www.greenheronengineering.com">www.greenheronengineering.com</a> .....	108
<b>Ham Ads</b> – <a href="http://www.arrl.org/ham-ad-listing">www.arrl.org/ham-ad-listing</a> .....	140
<b>Ham Radio Outlet</b> – <a href="http://www.hamradio.com">www.hamradio.com</a> .....	104, 105
<b>Hammond Mfg. Co.</b> – <a href="http://www.hammondmfg.com">www.hammondmfg.com</a> .....	118
<b>Hamvention®/ARRL Expo 2020</b> – <a href="http://www.hamvention.org">www.hamvention.org</a> .....	114
<b>Heil Sound</b> – <a href="http://www.heilsound.com">www.heilsound.com</a> .....	110
<b>Hy-Gain</b> – <a href="http://www.hy-gain.com">www.hy-gain.com</a> .....	10, 115
<b>ICOM America</b> – <a href="http://www.icomamerica.com">www.icomamerica.com</a> .....	107
<b>International Radio INRAD</b> – <a href="http://www.inrad.net">www.inrad.net</a> .....	11

Fun and affordable kits from  
**Pacific Antenna**

Tracer Injector      Tenna Dipper II      Micro Attenuator      Mini SWR Indicator

See our selection of quality  
Kits starting at \$5  
[www.qrpkits.com](http://www.qrpkits.com)

**Tennadyne**  
Log Periodic Antennas  
[www.tennadyne.com](http://www.tennadyne.com)  
P.O. Box 352, Alto, MI 49302  
Telephone: 616-622-4968

**Cubex**  
Quad Antennas  
[www.cubexquads.com](http://www.cubexquads.com)



## Contact Information:

Toll Free: 800-243-7768  
Fax: 860-594-4285  
E-mail: ads@arrl.org  
Web: www.arrl.org/ads

Additional advertising information  
is available on the web at:  
[www.arrl.org/ads](http://www.arrl.org/ads)

# Advertisers

<b>Intuitive Circuits, LLC</b> – www.icircuits.com .....	141
<b>Kenwood Communications</b> – www.kenwoodusa.com .....	Cover IV, 29, 130, 138
<b>LDG Electronics</b> – www.ldgelectronics.com .....	6
<b>Mayberry Sales &amp; Service, Inc.</b> – www.mayberrys.com .....	113
<b>MFJ Enterprises</b> – www.mfjenterprises.com .....	117, 119, 121, 123, 125, 127, 129, 131, 133, 135
<b>Mosley Electronics</b> – www.mosley-electronics.com .....	126
<b>Motosports of Ukiah</b> – www.hondashop.com .....	126
<b>NCG Company</b> – www.natcommgroup.com .....	3
<b>OCI-Olds Communications Inc.</b> – www.ocicom.com .....	143
<b>Pacific Antenna</b> – www.qrpkits.com .....	142
<b>Palomar Engineers</b> – www.Palomar-Engineers.com .....	126
<b>PreciseRF</b> – http://preciserf.com .....	141
<b>Quicksilver Radio Products</b> – www.qsradio.com .....	137
<b>Radio Club of JHS 22 NYC</b> – www.wb2jkj.org .....	138
<b>RF Parts Company</b> – www.rfparts.com .....	143
<b>RT Systems</b> – www.rtsystems.com .....	113
<b>RW Antenna Store</b> – www.rwantennastore.com .....	109
<b>SEA PAC/NW Division Convention</b> – www.seapac.org .....	110
<b>SOTabeams</b> – www.sotabeams.co.uk .....	142
<b>SteppIR Communications Systems</b> – www.steppir.com .....	7
<b>SwapMyRigs</b> – www.swapmyrigs.com .....	126
<b>Tac-Comm</b> – www.tac-comm.com .....	113
<b>Tashjian Towers</b> – www.TashTowers.com .....	118
<b>Tennadyne</b> – www.tennadyne.com .....	142
<b>Ten-Ten International Net, Inc.</b> – www.ten-ten.org .....	141
<b>Tigertronics</b> – www.tigertronics.com .....	141
<b>Timewave Technology, Inc.</b> – www.timewave.com .....	122
<b>TWR Radio</b> – twr.org/serve .....	27
<b>Vibroplex</b> – www.vibroplex.com .....	11
<b>W5SWL Electronics</b> – www.w5swl.com .....	118
<b>Warren Gregoire &amp; Associates</b> – www.superbheadsets.com .....	142
<b>West Mountain Radio</b> – www.westmountainradio.com .....	18
<b>Wireman</b> – www.coaxman.com .....	118
<b>Yaesu USA</b> – www.yaesu.com .....	Cover II, 1

Hear the weakest signals on  
VHF and UHF. Learn how at  
[www.ocicom.com](http://www.ocicom.com)

From **MILLIWATTS**  
To **KILOWATTS**<sup>SM</sup>  
**In Stock Now!**

**Semiconductors  
for Manufacturing  
and Servicing  
Communications  
Equipment**

Visit  
Our  
Website

- **RF Modules**
- **Semiconductors**
- **Transmitter Tubes**

Se Habla Español • We Export

Phone: **760-744-0700**  
Toll-Free: **800-737-2787**  
(Orders only) **800-RF PARTS**  
Website: **www.rfparts.com**  
Fax: **760-744-1943**  
**888-744-1943**  
Email: **rfp@rfparts.com**



**RF PARTS**  
COMPANY



# The ARRL Diamond Club

*Enjoy All the Benefits of  
Membership...and be a Champion  
of the Amateur Radio Community!*

## **EVERY DONATION**

Helps support a range of ARRL programs and services that our members depend on. From advocacy, to contesting, to public service training, and much more, your unrestricted, tax-deductible gift to the Diamond Club Annual Giving program helps keep our programs and services advancing and accessible.

## **ADDED BENEFITS**

- Diamond Club donations begin at \$85 and are recognized with a Diamond Club lapel pin, window decals, and more.
- At the \$250 level you may place a personalized brick in our Diamond Club Terrace.
- The more you give, the more benefits continue to increase!  
Visit [www.arrl.org/the-arri-diamond-club](http://www.arrl.org/the-arri-diamond-club) for details.

## **SPECIAL RECOGNITION FOR DONORS of \$1,000 OR MORE**

Individuals who give \$1,000 or more will receive an invitation to the **ARRL Annual Donor Recognition Reception, May 14, 2020** at Dayton Hamvention® in Ohio.

For more information, contact the Melissa Stemmer, ARRL Development Manager at [mstemmer@arrl.org](mailto:mstemmer@arrl.org) or call **860-594-0348**.

If you're an ARRL Life Member, a \$50 donation qualifies you for Diamond Club status.



# Good times await you with the Tri-Band AnyTone 578!

**NEW**

The DMR mobile you have been dreaming about is finally here!  
Up to 50W of Tri-Band power.

Visit the link or call the number below to learn more!

## AnyTone AT-D578UVIIIIPRO

- TRI-BAND
- 50W 2m, 5W 220, 40W 70cm
- Bluetooth
- GPS
- APRS

Free 578 Course (\$97 Value)  
At BridgeCom University

**BridgeCom**  
SYSTEMS  
816-532-8451  
sales@bridgecomsystems.com

TO LEARN MORE VISIT:  
[www.bridgecomsystems.com/578](http://www.bridgecomsystems.com/578)

# APRS® / D-STAR®

## TH-D74A 144/220/430 MHz Tribander

The TH-D74A represents the ultimate in APRS and D-STAR performance. KENWOOD has already garnered an enviable reputation with the TH-D72A handheld APRS amateur radio transceiver. Now it has raised the bar even further with the TH-D74A, adding support for D-STAR, the digital voice & data protocol developed by the JARL, and enabling simultaneous APRS and D-STAR operation – an industry first.



- ▶ APRS compliance using packet communication to exchange real-time GPS position information and messages
- ▶ Compliant with digital/voice mode D-STAR digital amateur radio networks
- ▶ Built-in high performance GPS unit with Auto Clock Setting
- ▶ Wide-band and multi-mode reception
- ▶ 1.74" (240 x 180 pixel) Transflective color TFT display
- ▶ IF Filtering for improved SSB/CW/AM reception
- ▶ High performance DSP-based audio processing & voice recording
- ▶ Compliant with Bluetooth, microSD & Micro-USB standards
- ▶ External Decode function (PC Decode 12kHz IF Output, BW:15 kHz)
- ▶ Free software for Memory and Frequency Control Program
- ▶ Data Import / Export (Digital Repeater List, Call sign, Memory Channel)
- ▶ Four TX Power selections (5/2/0.5/0.05 W)
- ▶ Dust and Water resistant IP54/55 standards

APRS (The Automatic Packet Reporting System) is a registered American trademark of WB4APR (Mr. Bob Bruninga).  
D-Star is a digital radio protocol developed by JARL (Japan Amateur Radio League).

# KENWOOD

Customer Support/Distribution Customer Support:  
(310) 639-4200 Fax: (310) 537-8235

[www.kenwood.com/usa](http://www.kenwood.com/usa)



ADS#38419